

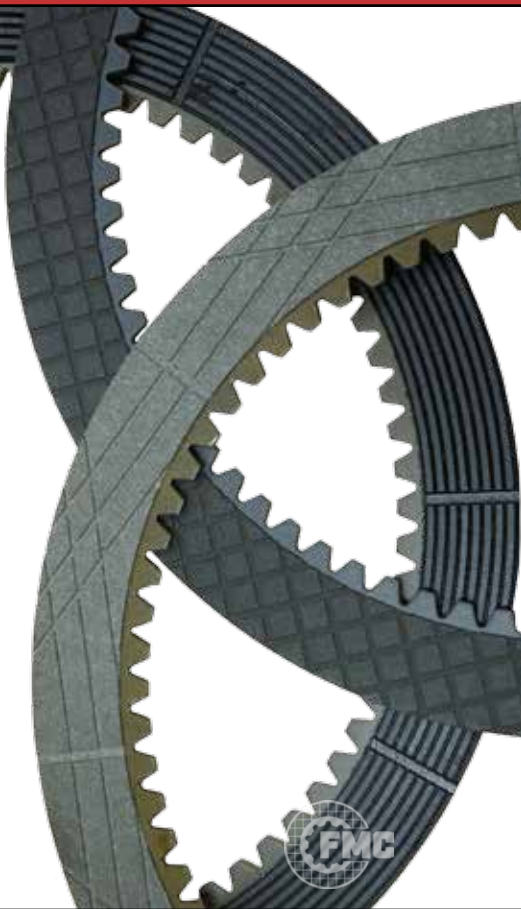

Welcome to the current edition of our Catalogue.

FMC commenced operation in the U.K. in 1991. Originally our specific goal was to provide a high quality product and first class service geared to the Earthmoving and Mining aftermarkets for supply of common friction parts throughout the world.



This catalogue is testament to our success and history. We have developed a vast array of friction, clutch, brake and mating plates, all of which are manufactured by us and supplied in original specification materials and available for purchase.



Our products are precision engineered in our own state-of-the-art production facilities in Nottinghamshire. This ensures the quality of raw materials and the quality throughout all manufacturing processes to the final inspection. Other products are specifically manufactured from our tooling at key manufacturing plants around the world. These plants play a strategic role in the OEM supply of materials to our market.



Our two facilities in the U.K. hold key individual roles:

**Leighton Buzzard;**

Our principle office & warehouse for Sales,  
Ordering parts,  
Storage, packing,  
Distribution and shipping.

**Sutton-in-Ashfield;**

Research & development,  
Design,  
Manufacturing,  
Engineering and  
technology centre.

All of our products are available from our UK warehouse or via specialist distributors located around the world.

Our current strategy is to continue to develop our market by introducing new friction discs to meet increasing demand from our customers and to a diverse market. Also to advance friction technology by working with clients in developing bespoke vehicle and machinery friction solutions.

**Note:**

This catalogue is also available on-line at our website. <http://www.frictionmarketing.co.uk/>



FMC are proudly represented by stocking distributors or representative agents in most countries throughout the world.

The following personnel have specific responsibility for the following countries:

|  |   |
|--|---|
| Europe (Except Italy)  | <b>Steven Johnson</b><br>stevej@frictionmarketing.co.uk             |
| Italy, Asia, (except Far East), North Africa, Middle East, Turkey,   | <b>Marco Calvello</b><br>marco@frictionmarketing.co.uk              |
| Latin America  | <b>Cristian Tisko</b><br>cristian@frictionmarketing.co.uk           |
| North America, South Africa, Australasia, China, Japan & South Korea | <b>David Waterfield</b><br>david.waterfield@frictionmarketing.co.uk |

|                              |  |
|------------------------------|--|
| <b>Internal Key Contacts</b> |  |
| Shipping Manager             | <b>Sara Cavanagh</b><br>sara@frictionmarketing.co.uk |
| Quality Control              | <b>Phil Colton</b><br>Phil@frictionmarketing.co.uk   |

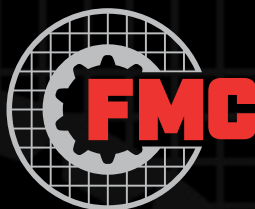

**Friction Marketing Company Limited.**

**Distribution, Warehouse & Registered Office:**

Unit 5, Eden Court, Eden Way,  
Leighton Buzzard, LU7 4FY. England.

Telephone: +44 (0)1525 376700

Fax.: +44 (0)1525 377170

**Friction Marketing Company Limited.**

**Manufacturing, Research & Development Centre:**

Units 3-7 Forest Enterprise Centre  
Coxmore Road, Sutton in Ashfield  
Nottinghamshire NG17 5LA. England.



This brochure contains our current range of original quality, heavy-duty friction materials, together with steel mating plates.

The range of products is continually expanding; therefore, please contact us if the item you require is not shown.

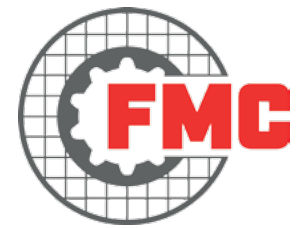

| CONTENTS                                   | PAGE | CONTENTS  | PAGE | CONTENTS                           | PAGE |
|--|------|---|------|------------------------------------|------|
| ADAMS                                      | 1    | GRADALL   | 76   | NOUVA DETAS                        | 144  |
| A.E.C.                                     | 1    | GRAZIANO  | 76   | O&K                                | 145  |
| AGRALE                                     | 1    | GROVE   | 76   | OKAMURA                            | 146  |
| AHLMANN                                    | 1    | HALLA   | 78   | OMCI                               | 146  |
| AISIN                                      | 1    | HAMWORTHY   | 78   | ORMIG                              | 147  |
| ALLIS CHALMERS (also see Fiat Allis)       | 1    | HANOMAG (Komatsu)                                 | 78   | ORTLINGHAUS                        | 147  |
| ALLISON                                    | 3    | HARRISON  | 79   | PANHARD                            | 148  |
| ALVIS                                      | 6    | HATRA   | 79   | P&H                                | 148  |
| ASTRA                                      | 6    | HAULOTTE  | 80   | PERLINI                            | 148  |
| ATLAS                                      | 7    | HINDUSTAN MOTORS (Caterpillar)                    | 80   | PETTIBONE                          | 148  |
| AUSA                                       | 7    | HITACHI   | 80   | POCLAIN                            | 148  |
| AUSCO                                      | 7    | HOWARD ROTAVATOR                                  | 81   | PPM                                | 148  |
| BALKANCAR                                  | 9    | HURTH (Dana)                                      | 81   | PRM NEWAGE                         | 149  |
| BELAZ                                      | 9    | HURTH MARINE                                      | 82   | REINTJES                           | 150  |
| J.C. BAMFORD                               | 9    | HYDREMA   | 82   | RENAULT TRACTOR                    | 150  |
| BELL (also see John Deere)                 | 13   | HYSTER  | 82   | RENAULT TRUCK                      | 150  |
| BENATI                                     | 14   | HYUNDAI (also see Clark + ZF)                     | 85   | ROCKWELL / AXLETECH / MERITOR      | 150  |
| BENFORD                                    | 14   | INNOCENTI   | 90   | SAME / LAMBORGINI / HURLIMANN      | 152  |
| BENFRA                                     | 14   | INTERNATIONAL (Dresser)                           | 90   | SAMSUNG (also see Clark)           | 153  |
| BOMAG                                      | 14   | IOCHPE MAXION                                     | 94   | SANDERSON                          | 153  |
| BRAY                                       | 15   | ISEKI   | 94   | SCANIA                             | 154  |
| BREVINI                                    | 15   | ITOCHU  | 94   | SCHAEFF                            | 154  |
| BROCKHOUSE                                 | 15   | IVECO   | 94   | SCHOPF                             | 154  |
| BRODERSON                                  | 15   | JEFFREY   | 95   | SELF CHANGING GEARS                | 154  |
| CARCO WINCHES                              | 16   | JLG (Omniquip)                                    | 95   | SENNENBOGEN                        | 154  |
| CARRARO                                    | 16   | JOHN DEERE (also see Funk)                        | 95   | SELLICK                            | 155  |
| CASE (David Brown)                         | 17   | JOY   | 101  | SHINKO                             | 155  |
| CATERPILLAR                                | 25   | JUNGHEINRICH                                      | 101  | SISU                               | 155  |
| CESAB                                      | 44   | KALMAR  | 102  | SMV                                | 155  |
| CHAMPION (also see Clark + Allison)        | 45   | KALMAR CLIMAX<br>(also see Brockhouse + Graziano) | 103  | SOILMEC                            | 155  |
| CHELSEA                                    | 45   | KATO  | 103  | SPICER (Dana, Turner Powertrain)   | 155  |
| CHINA GEAR                                 | 45   | KAWASAKI  | 103  | STEYR                              | 156  |
| CLAAS                                      | 47   | KESSLER   | 105  | STILL                              | 156  |
| CLARK / DANA                               | 47   | K.H.D.  | 105  | STROMAG                            | 156  |
| CLEARING                                   | 52   | KIRKSTALL   | 106  | SUMITOMO EATON                     | 156  |
| CLIMAX                                     | 52   | KOBELCO   | 106  | SVETRUCK                           | 156  |
| COLES CRANES                               | 52   | KOMATSU   | 107  | TADANO                             | 157  |
| CROWN                                      | 52   | KRAMER  | 117  | TAILIFT                            | 157  |
| DAEWOO / DOOSAN (also see ZF)              | 53   | KUBOTA  | 118  | TAMROCK                            | 157  |
| DAF  | 56   | LANCER BOSS (Steinbock)                           | 119  | TCI                                | 158  |
| DAIMLER                                    | 56   | LANDINI   | 119  | TCM FORKLIFT, SEE MITSUI           | 158  |
| DANFOSS                                    | 56   | LANSING   | 120  | TCM                                | 158  |
| DANTRUCK                                   | 57   | LE TOURNEAU                                       | 120  | TEREX (also see Allison)           | 159  |
| DEUTZ                                      | 57   | LEYLAND (Wilson)                                  | 120  | THWAITES                           | 162  |
| DITCH WITCH                                | 57   | LIEBHERR  | 120  | TIMBERJACK                         | 162  |
| DONGI MARINE                               | 57   | LIMB  | 123  | TONANCO                            | 162  |
| DRESSER                                    | 58   | LINDE   | 123  | TORO / TAMROCK / SANDVIK           | 162  |
| DRESSSTA                                   | 58   | LINK BELT SPEEDER SHOVELS                         | 123  | TOYOTA                             | 163  |
| DYNAHOE                                    | 58   | LIUGONG   | 124  | TROJAN                             | 164  |
| DYNAPAC                                    | 58   | LONGKING  | 124  | TUG                                | 165  |
| EDER                                       | 59   | LUNDBERG HYMAS                                    | 124  | TWIN DISC                          | 165  |
| EUCLID (also see Allison and Hitachi)      | 59   | MACK TRUCK  | 125  | UNIVERSAL TRACTOR BRASOV           | 166  |
| F & S                                      | 60   | MAFI  | 125  | UZEL                               | 166  |
| FAI / KOMATSU                              | 60   | MAHINDRA & MAHINDRA                               | 125  | VALMET / VALTRA                    | 166  |
| FANTUZZI                                   | 60   | MAN   | 125  | VENIERI                            | 167  |
| FARESIN                                    | 61   | MANITOU   | 125  | VOITH                              | 167  |
| FARMTRAC                                   | 61   | MARATHON LE TOURNEAU                              | 127  | VOLVO (also see Clark and Samsung) | 169  |
| FAY  | 61   | MASSEY FERGUSON                                   | 127  | WABCO (also see Allison)           | 178  |
| FENDT                                      | 61   | MATBRO  | 129  | WAGNER / ATLAS COPCO               | 178  |
| FENWICK                                    | 62   | MERCEDES BUS                                      | 129  | WARNER GEAR                        | 180  |
| FERMEC (Terex)                             | 62   | MICHIGAN (also see Euclid)                        | 130  | WINGET                             | 181  |
| FIAT ALLIS & FIAT HITACHI (Allis Chalmers) | 62   | MINNEAPOLIS MOLINE                                | 130  | XTREME                             | 181  |
| FIORI                                      | 67   | MITSUBISHI  | 131  | YALE                               | 182  |
| FORD                                       | 67   | NETZSCH   | 131  | YANMAR                             | 182  |
| FRISCH-FAUN                                | 70   | MITSUI TCM  | 132  | ZETOR                              | 183  |
| FUNK                                       | 71   | MOROOKA   | 133  | ZETTLEMAYER                        | 183  |
| FURAKAWA (Hitachi)                         | 71   | MOXY  | 133  | Z.F.                               | 183  |
| GALION                                     | 74   | NABCO   | 136  | CLUTCH BUTTONS & RIVETS            | 191  |
| GEHL                                       | 74   | NAF   | 136  |                                    |      |
| GENIE / TEREX                              | 74   | NEWAGE  | 136  |                                    |      |
| GETMAN                                     | 75   | NEW HOLLAND                                       | 136  |                                    |      |
| GHH  | 75   | NIIGATA   | 143  |                                    |      |
| GIRLING                                    | 75   | NISSAN  | 143  |                                    |      |
| GLEISBAU                                   | 75   |   |      |                                    |      |
| GM DIESEL MARINE                           | 76   |   |      |                                    |      |

Reference to other manufacturers and their part numbers, model numbers, symbols and other descriptions are for identification purposes only.

| REPLACES<br>OEM PT.NO.                    | FMC<br>PART NO. | MATERIAL   | GROOVE<br>DETAILS | TEETH/<br>TANGS | SIZE MM   | SIZE INCH                                |
|---|-----------------|------------|-------------------|-----------------|-----------|--|
| <b>ADAMS</b>                              |                 |            |                   |                 |           |  |
| 725193                                    | FM3072MP        | STEEL      | -----             | 77              | INT TH    | 241.3 x 158.8 x 1.6 9.5 x 6.25 x 0.063   |
| 725224                                    | FM1607          | BRONZE     | -----             | 119             | EXT TH    | 254.0 x 171.5 x 4.7 10.0 x 6.75 x 0.187  |
| <b>A.E.C.</b>                             |                 |            |                   |                 |           |  |
| D39615                                    | FM0405          | OBSOLETE   | -----             | 72              | (81)EX TH | 210.8 x 146.1 x 3.2 8.3 x 5.75 x 0.125   |
| <b>AGRALE</b>                             |                 |            |                   |                 |           |  |
| 8012.103.046.00.6                         | FM3474MP        | STEEL      | -----             | 4               | EXT LG    | 85.0 x 49.2 x 1.5 3.35 x 1.94 x 0.059    |
| 8012.103.047.00.4                         | FM2969          | BRONZE     | WAFFLE            | 22              | INT TH    | 71.7 x 44.0 x 1.6 2.82 x 1.73 x 0.063    |
| <b>AHLMANN</b>                            |                 |            |                   |                 |           |  |
| 410 266 5A                                | FM2969          | BRONZE     | WAFFLE            | 22              | INT TH    | 71.7 x 44.0 x 1.6 2.82 x 1.73 x 0.063    |
| 410 266 6A                                | FM3474MP        | STEEL      | -----             | 4               | EXT LG    | 85.0 x 49.2 x 1.5 3.35 x 1.94 x 0.059    |
| 410 268 8A                                | FM9485          | GRAPHITE   | SUNBURST          | 12              | INT TH    | 170.0 x 32.7 x 4.8 6.69 x 1.29 x 0.189   |
| 410 283 6A                                | FM4844MP        | STEEL      | -----             | 67              | (70)EX TH | 191.0 x 130.0 x 2.0 7.52 x 5.12 x 0.079  |
| 410 283 7A                                | FM3948MP        | STEEL      | -----             | 67              | (70)EX TH | 191.0 x 130.0 x 2.5 7.52 x 5.12 x 0.098  |
| 410 283 8A                                | FM3946MP        | STEEL      | -----             | 67              | (70)EX TH | 191.0 x 130.0 x 3.0 7.52 x 5.12 x 0.118  |
| 410 283 9A                                | FM3575          | PAPER      | 3 PASS            | 35              | INT TH    | 179.0 x 103.0 x 3.5 7.05 x 4.05 x 0.138  |
| 410 653 7A                                | FM4686MP        | STEEL      | -----             | 81              | EXT TH    | 243.6 x 152.1 x 2.5 9.59 x 5.99 x 0.098  |
| 410 653 9A                                | FM6896MP        | STEEL      | -----             | 81              | EXT TH    | 243.6 x 152.1 x 2.0 9.59 x 5.99 x 0.079  |
| 410 661 9A                                | FM4666-2.2      | STEEL      | HARDENED          | 6               | EXT SL    | 130.0 x 66.8 x 2.2 5.12 x 2.63 x 0.087   |
| 410 662 0A                                | FM4666MP        | STEEL      | HARDENED          | 6               | EXT SL    | 130.0 x 66.8 x 2.3 5.12 x 2.63 x 0.091   |
| 410 662 1A                                | FM4666-2.4      | STEEL      | HARDENED          | 6               | EXT SL    | 130.0 x 66.8 x 2.4 5.12 x 2.63 x 0.094   |
| 410 662 2A                                | FM4666-2.5      | STEEL      | HARDENED          | 6               | EXT SL    | 130.0 x 66.8 x 2.5 5.12 x 2.63 x 0.098   |
| 410 662 3A                                | FM4451          | MOLYBDENUM | SPR/WAG           | 46              | (50)IN TH | 117.5 x 62.6 x 2.6 4.63 x 2.46 x 0.102   |
| 410 695 8A                                | FM4647          | BRONZE     | SPR/RAD           | 34              | INT TH    | 100.0 x 68.2 x 1.6 3.94 x 2.69 x 0.061   |
| 410 695 7A                                | FM4650MP        | STEEL      | -----             | 24              | EXT TH    | 108.2 x 76.2 x 1.2 4.26 x 3 x 0.045      |
| 410 696 1A                                | FM7038MP        | STEEL      | HARD/BLACK        | 64              | EXT TH    | 196.4 x 140.0 x 2.9 7.73 x 5.51 x 0.114  |
| 410 696 2A                                | FM4933          | BRONZE     | WAF/WAG           | 45              | INT TH    | 187.0 x 132.6 x 3.0 7.36 x 5.22 x 0.118  |
| 410 824 2A                                | FM4089          | PAPER      | 3 PASS            | 48              | INT TH    | 232.7 x 142.0 x 4.0 9.16 x 5.59 x 0.157  |
| 411 028 8A                                | FM2811          | PAPER      | 4 PASS            | 34              | INT TH    | 277.0 x 167.0 x 4.5 10.91 x 6.57 x 0.177 |
| 411 040 0A                                | FM3606MP        | STEEL      | -----             | 88              | (91)EX TH | 293.0 x 185.0 x 4.0 11.54 x 7.28 x 0.157 |
| 411 040 2A                                | FM3608MP        | STEEL      | -----             | 88              | (91)EX TH | 293.0 x 185.0 x 4.5 11.54 x 7.28 x 0.177 |
| 419 974 2A                                | FM4449          | MOLYBDENUM | SPR/WAG           | 26              | INT TH    | 147.8 x 75.4 x 3.0 5.82 x 2.97 x 0.118   |
| <b>AISIN</b>                              |                 |            |                   |                 |           |  |
| 35634-3400A                               | FM3561          | PAPER      | WAFFLE            | 30              | INT TH    | 131.0 x 79.2 x 2.6 5.16 x 3.12 x 0.102   |
| 35634-3700                                | FM3561          | PAPER      | WAFFLE            | 30              | INT TH    | 131.0 x 79.2 x 2.6 5.16 x 3.12 x 0.102   |
| <b>ALLISCHALMERS (also see Fiatallis)</b> |                 |            |                   |                 |           |  |
| 1004870                                   | FM1216MP        | STEEL      | -----             | 60              | EXT TH    | 154.2 x 113.8 x 1.8 6.07 x 4.48 x 0.07   |
| 1004876                                   | FM1307OE        | BRONZE     | RADIAL            | 52              | INT TH    | 148.6 x 107.7 x 2.6 5.85 x 4.24 x 0.102  |
| 1005843                                   | FM1305OE        | BRONZE     | RADIAL            | 52              | INT TH    | 148.6 x 107.7 x 2.6 5.85 x 4.24 x 0.102  |
| 1018221                                   | FM5442MP        | STEEL      | END PLATE         | 54              | EXT TH    | 139.2 x 98.2 x 8.3 5.48 x 3.87 x 0.327   |
| 1018222                                   | FM1324MP        | STEEL      | -----             | 54              | EXT TH    | 139.2 x 98.6 x 1.8 5.48 x 3.88 x 0.07    |



# Allison Transmission Discs



| REPLACES<br>OEM PT.NO. | FMC<br>PART NO. | MATERIAL | GROOVE<br>DETAILS | TEETH/<br>TANGS | SIZE MM |       |   | SIZE INCH |   |     |      |   |      |   |       |
|------------------------|-----------------|----------|-------------------|-----------------|---------|-------|---|-----------|---|-----|------|---|------|---|-------|
| 1018224                | FM1935          | BRONZE   | 240 RADIAL        | 45              | INT TH  | 133.1 | x | 92.7      | x | 1.6 | 5.24 | x | 3.65 | x | 0.063 |
| 1018225                | FM5452MP        | STEEL    | END PLATE         | 54              | EXT TH  | 139.2 | x | 98.2      | x | 8.7 | 5.48 | x | 3.87 | x | 0.343 |
| 1018238                | FM1933          | BRONZE   | RADIAL            | 59              | INT TH  | 190.8 | x | 147.3     | x | 3.0 | 7.51 | x | 5.8  | x | 0.118 |
| 1018239                | FM1938MP        | STEEL    | -----             | 3               | EXT LG  | 214.9 | x | 155.7     | x | 1.8 | 8.46 | x | 6.13 | x | 0.07  |

### ALLISON

|         |            |           |          |     |           |       |   |       |   |     |       |   |       |   |       |
|---------|------------|-----------|----------|-----|-----------|-------|---|-------|---|-----|-------|---|-------|---|-------|
| 5196303 | FM1938MP   | STEEL     | -----    | 3   | EXT TH    | 214.9 | x | 155.7 | x | 1.8 | 8.46  | x | 6.13  | x | 0.07  |
| 5197160 | FM1649     | PAPER     | 2 PASS   | 45  | INT TH    | 133.1 | x | 92.7  | x | 1.6 | 5.24  | x | 3.65  | x | 0.063 |
| 6702963 | FM6694MP   | STEEL     | -----    | 6   | EXT LG    | 413.3 | x | 323.7 | x | 3.0 | 16.27 | x | 12.74 | x | 0.118 |
| 6703050 | FM6692MP   | STEEL     | -----    | 3   | EXT LG    | 285.6 | x | 203.3 | x | 3.0 | 11.24 | x | 8.0   | x | 0.118 |
| 6758737 | FM4910MP   | STEEL     | -----    | 8   | EXT LG    | 311.2 | x | 235.0 | x | 5.0 | 12.25 | x | 9.25  | x | 0.197 |
| 6759048 | FM5313     | BRONZE    | SPIRAL   | 4   | INT TH    | 243.8 | x | 204.2 | x | 6.3 | 9.6   | x | 8.04  | x | 0.247 |
| 6768446 | FM1965     | BRONZE    | SPR/WAG  | 60  | INT TH    | 253.7 | x | 187.5 | x | 3.9 | 9.99  | x | 7.38  | x | 0.153 |
| 6769326 | FM1294MP   | STEEL     | -----    | 30  | (90)EX TH | 387.4 | x | 321.8 | x | 5.0 | 15.25 | x | 12.67 | x | 0.195 |
| 6770264 | FM4774-5.0 | STEEL     | -----    | 8   | EXT LG    | 257.4 | x | 181.2 | x | 5.0 | 10.14 | x | 7.14  | x | 0.197 |
| 6770590 | FM2667     | BRONZE    | SPIRAL   | 100 | INT TH    | 409.4 | x | 314.2 | x | 4.5 | 16.12 | x | 12.37 | x | 0.178 |
| 6770647 | FM1245     | BRONZE    | SUNBURST | 73  | INT TH    | 371.3 | x | 303.0 | x | 5.2 | 14.62 | x | 11.93 | x | 0.205 |
| 6770917 | FM5276MP   | STEEL     | -----    | 8   | EXT LG    | 209.0 | x | 157.0 | x | 2.5 | 8.23  | x | 6.18  | x | 0.096 |
| 6771348 | FM5000MP   | STEEL     | -----    | 4   | EXT LG    | 211.0 | x | 157.0 | x | 7.6 | 8.31  | x | 6.18  | x | 0.299 |
| 6771349 | FM5316MP   | STEEL     | -----    | 4   | EXT LG    | 255.5 | x | 219.7 | x | 6.3 | 10.06 | x | 8.65  | x | 0.248 |
| 6771491 | FM5827     | BRONZE    | SUNBURST | 52  | INT TH    | 292.1 | x | 213.9 | x | 5.1 | 11.5  | x | 8.42  | x | 0.201 |
| 6771533 | FM3347     | BRONZE    | SUNBURST | 72  | INT TH    | 246.1 | x | 178.1 | x | 4.9 | 9.69  | x | 7.01  | x | 0.193 |
| 6771858 | FM4772MP   | STEEL     | -----    | 8   | EXT LG    | 257.3 | x | 190.5 | x | 5.0 | 10.13 | x | 7.5   | x | 0.197 |
| 6774409 | FM8212MP   | STEEL     | -----    | 6   | EXT LG    | 244.8 | x | 182.5 | x | 2.4 | 9.64  | x | 7.19  | x | 0.094 |
| 6775541 | FM1965     | BRONZE    | SPR/WAG  | 60  | INT TH    | 253.7 | x | 187.5 | x | 3.9 | 9.99  | x | 7.38  | x | 0.153 |
| 6776092 | FM3568MP   | STEEL     | -----    | 8   | EXT LG    | 330.1 | x | 255.8 | x | 3.1 | 13    | x | 10.08 | x | 0.122 |
| 6776610 | FM1296MP   | STEEL     | -----    | 30  | (90)EX TH | 387.4 | x | 321.8 | x | 3.0 | 15.25 | x | 12.67 | x | 0.12  |
| 6777592 | FM2467     | BRONZE    | SPR/RAD  |     |           | 253.5 | x | 74.4  | x | 3.9 | 9.98  | x | 2.93  | x | 0.153 |
| 6777796 | FM1320MP   | STEEL     | -----    | 35  | EXT TH    | 450.9 | x | 389.6 | x | 5.0 | 17.75 | x | 15.34 | x | 0.195 |
| 6779887 | FM3916MP   | STEEL     | -----    | 8   | EXT SL    | 468.0 | x | 388.0 | x | 5.0 | 18.43 | x | 15.28 | x | 0.197 |
| 6830221 | FM1179     | GRAPHITE  | SUNBURST | 60  | INT TH    | 253.7 | x | 187.5 | x | 3.9 | 9.99  | x | 7.38  | x | 0.153 |
| 6830293 | FM1417     | CARBON PA | SUNBURST | 57  | INT TH    | 303.8 | x | 235.2 | x | 3.9 | 11.96 | x | 9.26  | x | 0.153 |
| 6830295 | FM1243     | GRAPHITE  | SUNBURST | 73  | INT TH    | 371.3 | x | 303.0 | x | 5.2 | 14.62 | x | 11.93 | x | 0.205 |
| 6830368 | FM1965     | BRONZE    | SPR/WAG  | 60  | INT TH    | 253.7 | x | 187.5 | x | 3.9 | 9.99  | x | 7.38  | x | 0.153 |
| 6830920 | FM3569     | BRONZE    | SUNBURST | 72  | INT TH    | 371.3 | x | 303.0 | x | 5.2 | 14.62 | x | 11.93 | x | 0.205 |
| 6830950 | FM2923     | BRONZE    | SPIRAL   | 59  | INT TH    | 199.9 | x | 144.8 | x | 3.8 | 7.87  | x | 5.7   | x | 0.15  |
| 6831641 | FM2798MP   | STEEL     | -----    | 9   | EXT LG    | 246.9 | x | 184.7 | x | 2.5 | 9.72  | x | 7.27  | x | 0.1   |
| 6831705 | FM2796MP   | STEEL     | -----    | 30  | EXT LG    | 219.0 | x | 167.5 | x | 2.5 | 8.62  | x | 6.59  | x | 0.1   |
| 6832138 | FM2957S    | BRONZE    | SUNBURST | 89  | INT TH    | 433.3 | x | 371.1 | x | 5.1 | 17.06 | x | 14.61 | x | 0.201 |
| 6833972 | FM1311     | GRAPHITE  | SUNBURST | 73  | INT TH    | 371.3 | x | 303.0 | x | 5.2 | 14.62 | x | 11.93 | x | 0.205 |
| 6834348 | FM2658MP   | STEEL     | -----    | 36  | EXT LG    | 247.1 | x | 186.2 | x | 2.5 | 9.73  | x | 7.33  | x | 0.1   |
| 6834370 | FM2613     | PAPER     | 2 PASS   | 30  | INT TH    | 182.4 | x | 129.5 | x | 2.5 | 7.18  | x | 5.1   | x | 0.098 |
| 6834374 | FM2624MP   | STEEL     | -----    | 18  | EXT TH    | 194.0 | x | 140.5 | x | 2.5 | 7.64  | x | 5.53  | x | 0.1   |
| 6834487 | FM4961     | OBSOLETE  | 2 PASS   | 62  | INT TH    | 319.0 | x | 259.3 | x | 3.8 | 12.56 | x | 10.21 | x | 0.148 |
| 6834488 | FM2618MP   | STEEL     | -----    | 16  | EXT TH    | 335.0 | x | 273.1 | x | 2.6 | 13.19 | x | 10.75 | x | 0.103 |
| 6834679 | FM2620MP   | STEEL     | -----    | 14  | EXT TH    | 244.6 | x | 182.9 | x | 2.6 | 9.63  | x | 7.2   | x | 0.103 |
| 6834680 | FM2626MP   | STEEL     | -----    | 38  | EXT TH    | 335.0 | x | 275.1 | x | 2.6 | 13.19 | x | 10.83 | x | 0.103 |

| REPLACES<br>OEM PT.NO. | FMC<br>PART NO. | MATERIAL  | GROOVE<br>DETAILS | TEETH/<br>TANGS | SIZE MM   | SIZE INCH                                 |
|------------------------|-----------------|-----------|-------------------|-----------------|-----------|---|
| 6834720                | FM2622MP        | STEEL     | -----             | 16              | EXT TH    | 335.0 x 272.9 x 3.0 13.19 x 10.75 x 0.12  |
| 6834766                | FM2628MP        | STEEL     | -----             | 38              | EXT TH    | 335.0 x 275.1 x 3.0 13.19 x 10.83 x 0.12  |
| 6835151                | FM2609          | PAPER     | 2 PASS            | 42              | INT TH    | 149.6 x 110.0 x 2.0 5.89 x 4.33 x 0.08    |
| 6835152                | FM2669          | PAPER     | 2 PASS            | 60              | INT TH    | 207.3 x 154.4 x 2.6 8.16 x 6.08 x 0.103   |
| 6835329                | TBA             | GRAPHITE  | SUNBURST          | 16              | INT TH    | 400.1 x 214.9 x 5.4 15.75 x 8.46 x 0.213  |
| 6835475                | FM2624MP        | STEEL     | -----             | 18              | EXT TH    | 194.0 x 140.5 x 2.5 7.64 x 5.53 x 0.1     |
| 6835687                | FM2611          | PAPER     | 2 PASS            | 80              | INT TH    | 231.6 x 174.2 x 2.5 9.12 x 6.86 x 0.098   |
| 6835707                | FM2660MP        | STEEL     | -----             | 11              | EXT LG    | 292.1 x 224.3 x 2.5 11.5 x 8.83 x 0.1     |
| 6835720                | FM2615          | PAPER     | 2 PASS            | 50              | INT TH    | 275.3 x 213.4 x 3.2 10.84 x 8.4 x 0.125   |
| 6835748                | FM1181          | GRAPHITE  | SUNBURST          | 62              | INT TH    | 319.0 x 259.1 x 3.8 12.56 x 10.2 x 0.148  |
| 6835976                | FM2611          | PAPER     | 2 PASS            | 80              | INT TH    | 231.6 x 174.2 x 2.5 9.12 x 6.86 x 0.098   |
| 6835996                | FM5261          | BRONZE    | SPR/RAD           | 59              | INT TH    | 243.8 x 170.7 x 3.9 9.6 x 6.72 x 0.154    |
| 6835997                | FM5893          | BRONZE    | SPR/RAD           | 59              | INT TH    | 218.2 x 170.7 x 3.9 8.59 x 6.72 x 0.153   |
| 6836518                | FM2800MP        | STEEL     | -----             | 12              | (14)EX LG | 159.0 x 116.0 x 2.3 6.26 x 4.57 x 0.09    |
| 6837422                | FM2856MP        | STEEL     | -----             | 21              | EXT TH    | 268.7 x 201.9 x 3.0 10.58 x 7.95 x 0.118  |
| 6837565                | FM1965          | BRONZE    | SPR/WAG           | 60              | INT TH    | 253.5 x 187.7 x 3.9 9.98 x 7.39 x 0.153   |
| 6837690                | FM2858MP        | STEEL     | -----             | 6               | EXT TH    | 274.3 x 201.9 x 2.7 10.8 x 7.95 x 0.107   |
| 6838693                | FM4907          | GRAPHITE  | SUNBURST          | 52              | INT TH    | 292.1 x 213.9 x 4.0 11.5 x 8.42 x 0.156   |
| 6838694                | FM4770MP        | STEEL     | -----             | 8               | EXT LG    | 310.9 x 234.8 x 3.0 12.24 x 9.25 x 0.119  |
| 6839914                | FM2692MP        | STEEL     | -----             | 8               | EXT LG    | 330.1 x 255.8 x 3.1 13.0 x 10.08 x 0.122  |
| 6880727                | TBA             | PAPER     | 2 PASS            | 62              | INT TH    | 319.0 x 259.3 x 3.8 12.56 x 10.21 x 0.148 |
| 6884958                | FM2611          | PAPER     | 2 PASS            | 80              | INT TH    | 231.6 x 174.2 x 2.5 9.12 x 6.86 x 0.098   |
| 6885138                | FM2669          | PAPER     | 2 PASS            | 60              | INT TH    | 207.3 x 154.4 x 2.6 8.16 x 6.08 x 0.103   |
| 8625197                | FM2800MP        | STEEL     | -----             | 12              | (14)EX LG | 159.0 x 116.0 x 2.3 6.26 x 4.57 x 0.09    |
| 8625797                | FM2800MP        | STEEL     | -----             | 12              | (14)EX LG | 159.0 x 116.0 x 2.3 6.26 x 4.57 x 0.09    |
| 23010122               | FM1179          | GRAPHITE  | SUNBURST          | 60              | INT TH    | 253.7 x 187.5 x 3.9 9.99 x 7.38 x 0.153   |
| 23010123               | FM1417          | CARBON PA | SUNBURST          | 57              | INT TH    | 303.8 x 235.2 x 3.9 11.96 x 9.26 x 0.153  |
| 23010124               | FM1243          | GRAPHITE  | SUNBURST          | 73              | INT TH    | 371.3 x 303.0 x 5.2 14.62 x 11.93 x 0.205 |
| 23010125               | TBA             | GRAPHITE  | SUNBURST          | 16              | INT TH    | 400.1 x 214.9 x 5.4 15.75 x 8.46 x 0.213  |
| 23010436               | FM1181          | GRAPHITE  | SUNBURST          | 62              | INT TH    | 319.0 x 259.1 x 3.8 12.56 x 10.2 x 0.148  |
| 23010437               | FM1311          | GRAPHITE  | SUNBURST          | 73              | INT TH    | 371.3 x 303.0 x 5.2 14.62 x 11.93 x 0.205 |
| 23010438               | FM1177          | GRAPHITE  | SUNBURST          | 72              | INT TH    | 371.3 x 303.0 x 5.2 14.62 x 11.93 x 0.205 |
| 23010439               | TBA             | PAPER     | 2 PASS            | 62              | INT TH    | 319.0 x 259.3 x 3.8 12.56 x 10.21 x 0.148 |
| 23010871               | FM2467          | BRONZE    | SPR/RAD           |                 |           | 253.5 x 74.4 x 3.9 9.98 x 2.93 x 0.153    |
| 23013787               | FM2793          | PAPER     | 2 PASS            | 71              | INT TH    | 275.3 x 222.3 x 3.2 10.84 x 8.75 x 0.125  |
| 23015720               | FM2793          | PAPER     | 2 PASS            | 71              | INT TH    | 275.3 x 222.3 x 3.2 10.84 x 8.75 x 0.125  |
| 23015971               | FM2955          | GRAPHITE  | SUNBURST          | 89              | INT TH    | 433.3 x 371.3 x 5.2 17.06 x 14.62 x 0.205 |
| 23016606               | FM2658MP        | STEEL     | -----             | 36              | EXT LG    | 247.1 x 186.2 x 2.5 9.73 x 7.33 x 0.1     |
| 23016608               | FM2660MP        | STEEL     | -----             | 11              | EXT LG    | 292.1 x 224.3 x 2.5 11.5 x 8.83 x 0.1     |
| 23016610               | FM2624MP        | STEEL     | -----             | 18              | EXT TH    | 194.0 x 140.5 x 2.5 7.64 x 5.53 x 0.1     |
| 23017289               | FM2692MP        | STEEL     | -----             | 8               | EXT LG    | 330.1 x 255.8 x 3.1 13.0 x 10.08 x 0.122  |
| 23017553               | FM1324MP        | STEEL     | -----             | 54              | EXT TH    | 139.2 x 98.6 x 1.8 5.48 x 3.88 x 0.07     |
| 23040848               | FM1181          | GRAPHITE  | SUNBURST          | 62              | INT TH    | 319.0 x 259.1 x 3.8 12.56 x 10.2 x 0.148  |
| 23041097               | FM2669          | PAPER     | 2 PASS            | 60              | INT TH    | 207.3 x 154.4 x 2.6 8.16 x 6.08 x 0.103   |
| 23041615               | FM2955          | GRAPHITE  | SUNBURST          | 89              | INT TH    | 433.3 x 371.3 x 5.2 17.06 x 14.62 x 0.205 |
| 23041616               | FM1177          | GRAPHITE  | SUNBURST          | 72              | INT TH    | 371.3 x 303.0 x 5.2 14.62 x 11.93 x 0.205 |
| 23041786               | FM1181          | GRAPHITE  | SUNBURST          | 62              | INT TH    | 319.0 x 259.1 x 3.8 12.56 x 10.2 x 0.148  |
| 23042039               | FM1243          | GRAPHITE  | SUNBURST          | 73              | INT TH    | 371.3 x 303.0 x 5.2 14.62 x 11.93 x 0.205 |



| REPLACES<br>OEM PT.NO. | FMC<br>PART NO. | MATERIAL | GROOVE<br>DETAILS | TEETH/<br>TANGS | SIZE MM   |       |   | SIZE INCH |   |     |       |   |       |   |       |
|------------------------|-----------------|----------|-------------------|-----------------|-----------|-------|---|-----------|---|-----|-------|---|-------|---|-------|
| 23042197               | FM2609          | PAPER    | 2 PASS            | 42              | INT TH    | 149.6 | x | 110.0     | x | 2.0 | 5.89  | x | 4.33  | x | 0.08  |
| 23042198               | FM2669          | PAPER    | 2 PASS            | 60              | INT TH    | 207.3 | x | 154.4     | x | 2.6 | 8.16  | x | 6.08  | x | 0.103 |
| 23042199               | FM2611          | PAPER    | 2 PASS            | 80              | INT TH    | 231.6 | x | 174.1     | x | 2.5 | 9.12  | x | 6.86  | x | 0.098 |
| 23042200               | FM2613          | PAPER    | 2 PASS            | 30              | INT TH    | 182.4 | x | 129.5     | x | 2.5 | 7.18  | x | 5.1   | x | 0.098 |
| 23042201               | FM2615          | PAPER    | 2 PASS            | 50              | INT TH    | 275.3 | x | 213.4     | x | 3.2 | 10.84 | x | 8.4   | x | 0.125 |
| 23042202               | FM1181          | GRAPHITE | SUNBURST          | 62              | INT TH    | 319.0 | x | 259.1     | x | 3.8 | 12.56 | x | 10.2  | x | 0.148 |
| 23042210               | FM2793          | PAPER    | 2 PASS            | 71              | INT TH    | 275.3 | x | 222.3     | x | 3.2 | 10.84 | x | 8.75  | x | 0.125 |
| 23045054               | FM6136MP        | STEEL    | -----             | 15              | EXT LG    | 295.1 | x | 224.3     | x | 2.5 | 11.62 | x | 8.83  | x | 0.1   |
| 23045454               | FM1177          | GRAPHITE | SUNBURST          | 72              | INT TH    | 371.3 | x | 303.0     | x | 5.2 | 14.62 | x | 11.93 | x | 0.205 |
| 23045455               | FM1179          | GRAPHITE | SUNBURST          | 60              | INT TH    | 253.7 | x | 187.5     | x | 3.9 | 9.99  | x | 7.38  | x | 0.153 |
| 23045554               | FM2798MP        | STEEL    | -----             | 9               | EXT LG    | 246.9 | x | 184.7     | x | 2.5 | 9.72  | x | 7.27  | x | 0.1   |
| 23045573               | FM5028MP        | STEEL    | -----             | 48              | EXT TH    | 285.0 | x | 207.3     | x | 2.5 | 11.22 | x | 8.16  | x | 0.098 |
| 23045588               | FM5013          | PAPER    | 2 PASS            | 42              | (44)EX TH | 179.7 | x | 115.9     | x | 2.5 | 7.07  | x | 4.56  | x | 0.098 |
| 23045589               | FM5016MP        | STEEL    | -----             | 44              | INT TH    | 165.1 | x | 107.7     | x | 2.5 | 6.5   | x | 4.24  | x | 0.098 |
| 23046108               | FM2891          | PAPER    | 2 PASS            | 56              | INT TH    | 314.5 | x | 230.9     | x | 4.7 | 12.38 | x | 9.09  | x | 0.185 |
| 23047289               | FM1311          | GRAPHITE | SUNBURST          | 73              | INT TH    | 371.3 | x | 303.0     | x | 5.2 | 14.62 | x | 11.93 | x | 0.205 |
| 23047771               | FM2626MP        | STEEL    | -----             | 38              | EXT TH    | 335.0 | x | 275.0     | x | 2.6 | 13.19 | x | 10.83 | x | 0.103 |
| 23047772               | FM2628MP        | STEEL    | -----             | 38              | EXT TH    | 335.0 | x | 275.0     | x | 3.0 | 13.19 | x | 10.83 | x | 0.12  |
| 23048195               | FM2957          | BRONZE   | SUNBURST          | 89              | INT TH    | 433.3 | x | 371.1     | x | 5.1 | 17.06 | x | 14.61 | x | 0.201 |
| 23048510               | FM1311          | GRAPHITE | SUNBURST          | 73              | INT TH    | 371.3 | x | 303.0     | x | 5.2 | 14.62 | x | 11.93 | x | 0.205 |
| 23048511               | FM1311          | GRAPHITE | SUNBURST          | 73              | INT TH    | 371.3 | x | 303.0     | x | 5.2 | 14.62 | x | 11.93 | x | 0.205 |
| 23048628               | FM7989          | PAPER    | 2 PASS            | 84              | INT TH    | 252.7 | x | 207.8     | x | 2.5 | 9.95  | x | 8.18  | x | 0.098 |
| 29501209               | FM4159          | BRONZE   | SUNBURST          | 110             | IN TH     | 410.0 | x | 345.0     | x | 4.4 | 16.14 | x | 13.58 | x | 0.173 |
| 29501423               | FM5024MP        | STEEL    | -----             | 24              | (48)EX TH | 261.8 | x | 195.6     | x | 2.5 | 10.31 | x | 7.7   | x | 0.098 |
| 29503141               | FM5020MP        | STEEL    | -----             | 48              | EXT TH    | 281.1 | x | 216.8     | x | 2.5 | 10.07 | x | 8.54  | x | 0.098 |
| 29505765               | FM5040MP        | STEEL    | -----             | 24              | (56)EX TH | 352.3 | x | 279.1     | x | 2.5 | 13.87 | x | 10.99 | x | 0.098 |
| 29505720               | FM5036MP        | STEEL    | -----             | 56              | EXT TH    | 327.9 | x | 255.1     | x | 2.5 | 12.91 | x | 10.04 | x | 0.098 |
| 29505771               | FM5044MP        | STEEL    | -----             | 45              | (56)EX TH | 352.3 | x | 279.1     | x | 2.5 | 13.87 | x | 10.99 | x | 0.098 |
| 29505759               | FM5032MP        | STEEL    | -----             | 48              | INT TH    | 190.0 | x | 117.9     | x | 2.5 | 7.48  | x | 4.64  | x | 0.098 |
| 29505823               | FM5033          | PAPER    | 2 PASS            | 97              | (99)IN TH | 314.1 | x | 245.5     | x | 3.2 | 12.37 | x | 9.67  | x | 0.127 |
| 29511462               | FM5029          | PAPER    | 2 PASS            | 36              | (38)EX TH | 204.1 | x | 132.2     | x | 3.3 | 8.04  | x | 5.2   | x | 0.128 |
| 29515399               | FM2798MP        | STEEL    | -----             | 9               | EXT LG    | 246.9 | x | 184.7     | x | 2.5 | 9.72  | x | 7.27  | x | 0.1   |
| 29516170               | FM7989          | PAPER    | 2 PASS            | 84              | INT TH    | 252.7 | x | 207.8     | x | 2.5 | 9.95  | x | 8.18  | x | 0.098 |
| 29516171               | FM5021          | PAPER    | HOLES             | 75              | (77)IN TH | 242.3 | x | 185.4     | x | 2.5 | 9.54  | x | 7.3   | x | 0.098 |
| 29516172               | FM5025          | PAPER    | 2 PASS            | 79              | (81)IN TH | 254.3 | x | 198.2     | x | 3.2 | 10.01 | x | 7.8   | x | 0.126 |
| 29527014               | FM5045          | PAPER    | 2 PASS            | 74              | (77)IN TH | 320.7 | x | 266.4     | x | 3.8 | 12.63 | x | 10.49 | x | 0.148 |
| 29528207               | FM5021          | PAPER    | HOLES             | 75              | (77)IN TH | 242.3 | x | 185.4     | x | 2.5 | 9.54  | x | 7.3   | x | 0.098 |
| 29528209               | FM5021          | PAPER    | HOLES             | 75              | (77)IN TH | 242.3 | x | 185.4     | x | 2.5 | 9.54  | x | 7.3   | x | 0.098 |
| 29529291               | FM5037          | PAPER    | HOLES             | 75              | (77)IN TH | 320.7 | x | 266.4     | x | 3.8 | 12.63 | x | 10.49 | x | 0.148 |
| 29529492               | FM2611          | PAPER    | 2 PASS            | 80              | INT TH    | 231.6 | x | 174.1     | x | 2.5 | 9.12  | x | 6.86  | x | 0.098 |
| 29530312               | FM6299          | PAPER    | 2 PASS            | 36              | EXT TH    | 128.8 | x | 82.1      | x | 2.5 | 5.07  | x | 3.23  | x | 0.098 |
| 29530313               | FM6303          | PAPER    | 2 PASS            | 24              | INT TH    | 190.8 | x | 149.1     | x | 2.5 | 7.51  | x | 5.87  | x | 0.098 |
| 29530314               | FM6302MP        | STEEL    | -----             | 34              | INT TH    | 120.5 | x | 66.5      | x | 2.2 | 4.74  | x | 2.62  | x | 0.087 |
| 29530315               | FM6306MP        | STEEL    | -----             | 42              | EXT TH    | 203.5 | x | 160.0     | x | 2.2 | 8.01  | x | 6.3   | x | 0.087 |
| 29530330               | FM2800MP        | STEEL    | -----             | 12              | (14)EX LG | 159.0 | x | 116.0     | x | 2.3 | 6.26  | x | 4.57  | x | 0.09  |
| 29531048               | FM6310MP        | STEEL    | SLOTS             | 27              | (36)EX TH | 242.9 | x | 180.5     | x | 2.5 | 9.56  | x | 7.11  | x | 0.098 |
| 29531049               | FM6307          | PAPER    | SLOTS             | 117             | INT TH    | 220.4 | x | 171.8     | x | 2.5 | 8.68  | x | 6.76  | x | 0.098 |

| REPLACES<br>OEM PT.NO. | FMC<br>PART NO. | MATERIAL   | GROOVE<br>DETAILS | TEETH/<br>TANGS | SIZE MM     |       |   | SIZE INCH |   |     |       |   |       |   |       |
|------------------------|-----------------|------------|-------------------|-----------------|-------------|-------|---|-----------|---|-----|-------|---|-------|---|-------|
| 29532371               | FM5025          | PAPER      | 2 PASS            | 79              | (81)IN TH   | 254.3 | x | 198.2     | x | 3.2 | 10.01 | x | 7.8   | x | 0.126 |
| 29534834               | FM5041          | PAPER      | 2 PASS/HARDEN     | 75              | (77)IN TH   | 320.7 | x | 266.4     | x | 3.8 | 12.63 | x | 10.49 | x | 3.8   |
| 29535637               | FM6320MP        | STEEL      | SLOTS             | 27              | EX TH+ 3 LG | 244.0 | x | 180.5     | x | 3.2 | 9.61  | x | 7.11  | x | 0.126 |
| 29536334               | FM5013          | PAPER      | 2 PASS            | 42              | (44)EX TH   | 179.7 | x | 115.9     | x | 2.5 | 7.07  | x | 4.56  | x | 0.098 |
| 29536335               | FM5017          | PAPER      | 2 PASS            | 82              | (84)IN TH   | 267.7 | x | 207.8     | x | 2.5 | 10.54 | x | 8.18  | x | 0.098 |
| 29536336               | FM5021          | PAPER      | HOLES             | 75              | (77)IN TH   | 242.3 | x | 185.4     | x | 2.5 | 9.54  | x | 7.3   | x | 0.098 |
| 29536337               | FM5025          | PAPER      | 2 PASS            | 79              | (81)IN TH   | 254.3 | x | 198.2     | x | 3.2 | 10.01 | x | 7.8   | x | 0.126 |
| 29536338               | FM5029          | PAPER      | 2 PASS            | 36              | (38)EX TH   | 204.1 | x | 132.2     | x | 3.3 | 8.04  | x | 5.2   | x | 0.128 |
| 29536339               | FM5033          | PAPER      | 2 PASS            | 97              | (99)IN TH   | 314.1 | x | 245.5     | x | 3.2 | 12.37 | x | 9.67  | x | 0.127 |
| 29536340               | FM5037          | PAPER      | HOLES             | 75              | (77)IN TH   | 320.7 | x | 266.4     | x | 3.8 | 12.63 | x | 10.49 | x | 0.148 |
| 29536341               | FM5041          | PAPER      | 2 PASS/HARDEN     | 75              | (77)IN TH   | 320.7 | x | 266.4     | x | 3.8 | 12.63 | x | 10.49 | x | 3.8   |
| 29536343               | FM5016MP        | STEEL      | -----             | 44              | INT TH      | 165.1 | x | 107.7     | x | 2.5 | 6.5   | x | 4.24  | x | 0.098 |
| 29536344               | FM5020MP        | STEEL      | -----             | 48              | EXT TH      | 281.1 | x | 216.8     | x | 2.5 | 10.07 | x | 8.54  | x | 0.098 |
| 29536345               | FM5024MP        | STEEL      | -----             | 24              | (48)EX TH   | 261.8 | x | 195.6     | x | 2.5 | 10.31 | x | 7.7   | x | 0.098 |
| 29536346               | FM5028MP        | STEEL      | -----             | 48              | EXT TH      | 285.0 | x | 207.3     | x | 2.5 | 11.22 | x | 8.16  | x | 0.098 |
| 29536347               | FM5032MP        | STEEL      | -----             | 48              | INT TH      | 190.0 | x | 117.9     | x | 2.5 | 7.48  | x | 4.64  | x | 0.098 |
| 29536348               | FM5036MP        | STEEL      | -----             | 56              | EXT TH      | 327.9 | x | 255.1     | x | 2.5 | 12.91 | x | 10.04 | x | 0.098 |
| 29536349               | FM5040MP        | STEEL      | -----             | 24              | (56)EX TH   | 352.3 | x | 279.1     | x | 2.5 | 13.87 | x | 10.99 | x | 0.098 |
| 29536350               | FM5044MP        | STEEL      | -----             | 45              | (56)EX TH   | 352.3 | x | 279.1     | x | 2.5 | 13.87 | x | 10.99 | x | 0.098 |
| 29536481               | FM6314MP        | STEEL      | -----             | 36              | EXT TH      | 246.4 | x | 180.5     | x | 2.0 | 9.7   | x | 7.11  | x | 0.079 |
| 29536482               | FM6316MP        | STEEL      | -----             | 36              | EXT TH      | 246.4 | x | 180.5     | x | 2.5 | 9.7   | x | 7.11  | x | 0.098 |
| 29536483               | FM6318MP        | STEEL      | -----             | 36              | EXT TH      | 246.4 | x | 180.5     | x | 3.0 | 9.7   | x | 7.11  | x | 0.118 |
| 29537393               | FM6311          | PAPER      | RADIAL            | 115             | INT TH      | 220.2 | x | 173.4     | x | 2.5 | 8.67  | x | 6.83  | x | 0.098 |
| 29537887               | FM2611          | PAPER      | 2 PASS            | 80              | INT TH      | 231.6 | x | 174.1     | x | 2.5 | 9.12  | x | 6.86  | x | 0.098 |
| 29538424               | FM2611          | PAPER      | 2 PASS            | 80              | INT TH      | 231.6 | x | 174.2     | x | 2.5 | 9.12  | x | 6.86  | x | 0.098 |
| 29538468               | FM6299          | PAPER      | 2 PASS            | 36              | EXT TH      | 128.8 | x | 82.1      | x | 2.5 | 5.07  | x | 3.23  | x | 0.098 |
| 29538469               | FM6303          | PAPER      | 2 PASS            | 24              | INT TH      | 190.8 | x | 149.1     | x | 2.5 | 7.51  | x | 5.87  | x | 0.098 |
| 29541825               | FM5045          | PAPER      | 2 PASS            | 74              | (77)IN TH   | 320.7 | x | 266.4     | x | 3.8 | 12.63 | x | 10.49 | x | 0.148 |
| 29542506               | FM8016MP        | STEEL      | -----             | 24              | EXT TH      | 352.2 | x | 278.9     | x | 3.3 | 13.87 | x | 10.98 | x | 0.13  |
| 29542748               | FM8018MP        | STEEL      | -----             | 20              | EXT TH      | 261.7 | x | 195.5     | x | 3.3 | 10.3  | x | 7.7   | x | 0.13  |
| 29546270               | FM8727          | PAPER      | SLOTS/WAVED       | 117             | INT TH      | 220.4 | x | 171.8     | x | 1.8 | 8.68  | x | 6.76  | x | 0.071 |
| 29546276               | FM8725          | PAPER      | 2 PASS            | 36              | EXT TH      | 128.8 | x | 82.1      | x | 1.8 | 5.07  | x | 3.23  | x | 0.071 |
| 29546701               | FM6310MP        | STEEL      | SLOTS             | 27              | (36)EX TH   | 242.9 | x | 180.5     | x | 2.5 | 9.56  | x | 7.11  | x | 0.098 |
| 29549470               | FM2957S         | BRONZE     | SUNBURST          | 89              | INT TH      | 433.3 | x | 371.1     | x | 5.1 | 17.06 | x | 14.61 | x | 0.201 |
| <b>ALVIS</b>           |                 |            |                   |                 |             |       |   |           |   |     |       |   |       |   |       |
| FV659433               | FM3810MP        | STEEL      | -----             | 72              | EXT TH      | 187.7 | x | 136.5     | x | 1.5 | 7.39  | x | 5.37  | x | 0.058 |
| FV659434               | FM1159          | BRONZE     | RADIAL            | 55              | INT TH      | 176.3 | x | 122.4     | x | 2.4 | 6.94  | x | 4.82  | x | 0.095 |
| FV719063               | FM3812MP        | STEEL      | -----             | 72              | EXT TH      | 184.9 | x | 136.5     | x | 1.5 | 7.28  | x | 5.37  | x | 0.058 |
| FV793164               | FM3810MP        | STEEL      | -----             | 72              | EXT TH      | 187.7 | x | 136.5     | x | 1.5 | 7.39  | x | 5.37  | x | 0.058 |
| <b>ASTRA</b>           |                 |            |                   |                 |             |       |   |           |   |     |       |   |       |   |       |
| 063100027AS            | FM4449          | MOLYBDENUM | SPR/WAG           | 26              | INT TH      | 147.8 | x | 75.4      | x | 3.0 | 5.82  | x | 2.97  | x | 0.118 |

| REPLACES<br>OEM PT.NO. | FMC<br>PART NO. | MATERIAL  | GROOVE<br>DETAILS | TEETH/<br>TANGS | SIZE MM   |       |   | SIZE INCH |   |     |       |   |      |   |       |
|------------------------|-----------------|-----------|-------------------|-----------------|-----------|-------|---|-----------|---|-----|-------|---|------|---|-------|
| <b>ATLAS</b>           |                 |           |                   |                 |           |       |   |           |   |     |       |   |      |   |       |
| 2983397                | FM2715          | PAPER     | 2 PASS            | 19              | INT TH    | 152.0 | x | 34.0      | x | 4.8 | 5.98  | x | 1.34 | x | 0.189 |
| 2983400                | FM2890MP        | STEEL     | -----             | 3               | EXT LG    | 180.0 | x | 111.0     | x | 2.7 | 7.09  | x | 4.37 | x | 0.105 |
| 3968947                | FM2647          | PAPER     | 2 PASS            | 19              | IN TH     | 178.0 | x | 34.0      | x | 4.8 | 7.01  | x | 1.34 | x | 0.189 |
| 3983822                | FM2718MP        | STEEL     | -----             | 4               | EXT LG    | 129.0 | x | 76.0      | x | 1.5 | 5.08  | x | 2.99 | x | 0.059 |
| 3983833                | FM2719          | PAPER     | 2 PASS            | 33              | INT TH    | 117.9 | x | 68.1      | x | 2.2 | 4.64  | x | 2.68 | x | 0.087 |
| 3984389                | FM4625          | PAPER     | SUNBURST          | 16              | INT TH    | 201.0 | x | 40.5      | x | 4.9 | 7.91  | x | 1.59 | x | 0.192 |
| 3984470                | FM4606MP        | STEEL     | -----             | 3               | EXT LG    | 216.9 | x | 144.0     | x | 2.7 | 8.54  | x | 5.67 | x | 0.106 |
| 5615505                | FM6998MP        | STEEL     | -----             | 6               | EXT LG    | 334.0 | x | 225.0     | x | 3.0 | 13.15 | x | 8.86 | x | 0.118 |
| 6012097                | FM9393          | PAPER     | WAFFLE            | 45              | (54)IN TH | 298.0 | x | 106.2     | x | 5.0 | 11.73 | x | 4.18 | x | 0.197 |
| 6012325                | FM9122MP        | STEEL     | -----             | 6               | EXT LG    | 333.5 | x | 225.5     | x | 2.5 | 13.13 | x | 8.88 | x | 0.098 |
| 6012326                | FM7901          | GRAPHITE  | SUNBURST          | 45              | (54)IN TH | 298.0 | x | 106.0     | x | 3.9 | 11.73 | x | 4.17 | x | 0.152 |
| 6013097                | FM8979          | CARBON PA | WAFFLE            | 49              | (58)IN TH | 298.2 | x | 116.5     | x | 5.0 | 11.74 | x | 4.59 | x | 0.197 |
| 8000891                | FM8116MP        | STEEL     | -----             | 3               | EXT LG    | 189.6 | x | 130.5     | x | 3.7 | 7.46  | x | 5.14 | x | 0.146 |
| 8000892                | FM6977          | PAPER     | WAFFLE            | 54              | INT TH    | 178.0 | x | 105.6     | x | 3.8 | 7.01  | x | 4.16 | x | 0.148 |
| 8012028                | FM6980MP        | STEEL     | -----             | 4               | EXT LG    | 199.7 | x | 114.0     | x | 3.7 | 7.86  | x | 4.49 | x | 0.146 |
| 8015306                | FM9042MP        | STEEL     | HARDENED          | 8               | EXT LG    | 160.0 | x | 109.5     | x | 4.0 | 6.3   | x | 4.31 | x | 0.157 |
| <b>AUSA</b>            |                 |           |                   |                 |           |       |   |           |   |     |       |   |      |   |       |
| DA1120700601           | FM4606MP        | STEEL     | -----             | 3               | EXT LG    | 216.9 | x | 144.0     | x | 2.7 | 8.54  | x | 5.67 | x | 0.106 |
| DA1120761002           | FM4625          | PAPER     | SUNBURST          | 16              | INT TH    | 201.0 | x | 40.5      | x | 4.9 | 7.91  | x | 1.59 | x | 0.192 |
| <b>AUSCO</b>           |                 |           |                   |                 |           |       |   |           |   |     |       |   |      |   |       |
| 37893                  | FM2841          | BRONZE    | SPR/RAD           | 19              | INT TH    | 203.2 | x | 57.2      | x | 4.7 | 8.0   | x | 2.25 | x | 0.185 |
| 74551                  | FM6721          | PAPER     | 2 PASS            | 42              | INT TH    | 90.3  | x | 52.2      | x | 2.6 | 3.56  | x | 2.05 | x | 0.1   |
| 74552                  | FM6724MP        | STEEL     | -----             | 2               | EXT LG    | 151.8 | x | 60.7      | x | 1.9 | 5.98  | x | 2.39 | x | 0.075 |
| 74553                  | FM6726MP        | STEEL     | -----             | 2               | EXT LG    | 151.3 | x | 61.0      | x | 6.3 | 5.97  | x | 2.4  | x | 0.248 |
| 74996                  | FM6889          | PAPER     | 2 PASS            | 29              | INT TH    | 115.0 | x | 59.0      | x | 2.7 | 4.53  | x | 2.32 | x | 0.106 |



# JCB Clutch, Brake & PTO Discs

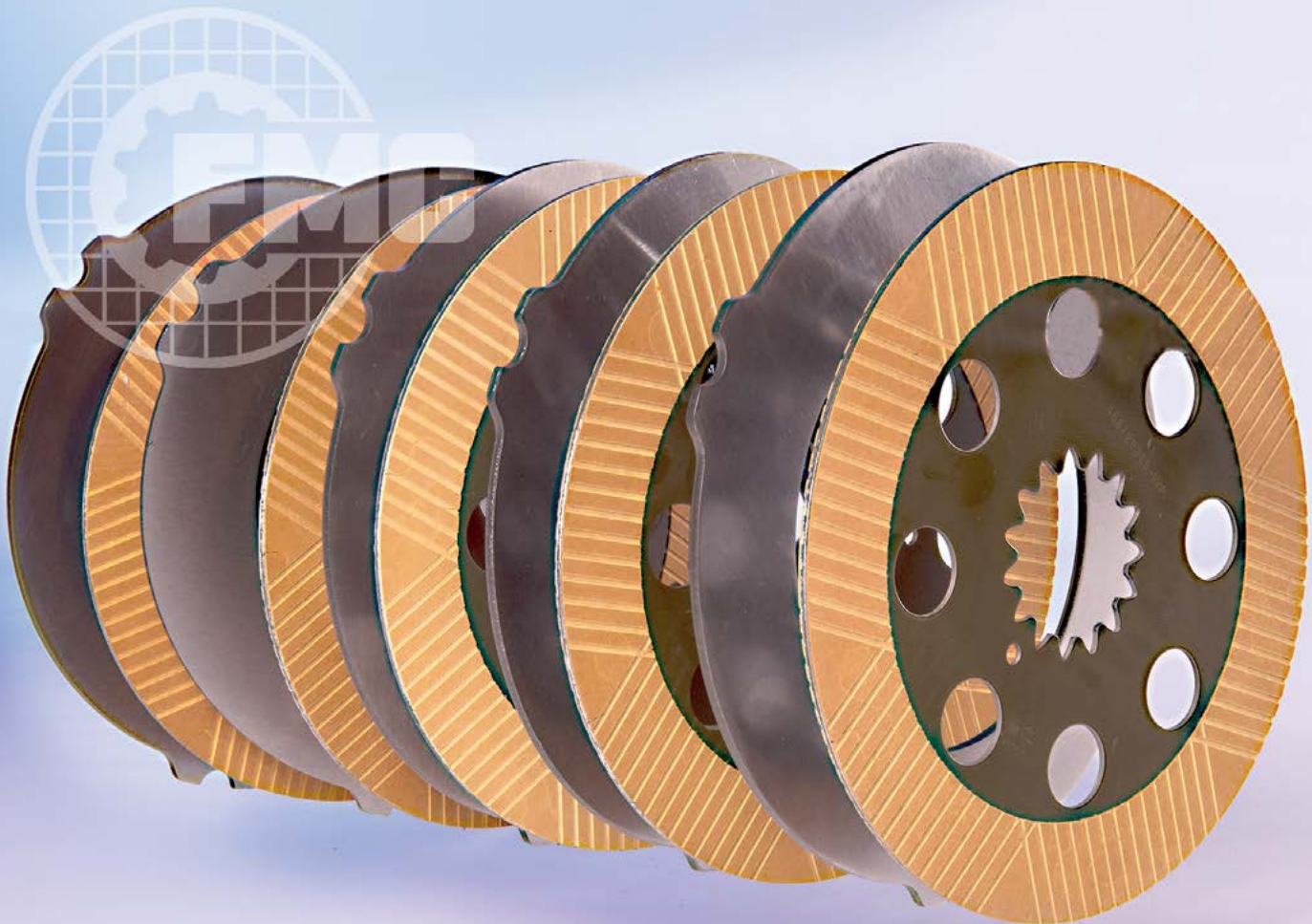

| REPLACES<br>OEM PT.NO. | FMC<br>PART NO. | MATERIAL  | GROOVE<br>DETAILS | TEETH/<br>TANGS | SIZE MM   |       |   |       | SIZE INCH |     |       |   |      |   |       |
|------------------------|-----------------|-----------|-------------------|-----------------|-----------|-------|---|-------|-----------|-----|-------|---|------|---|-------|
| <b>BELAZ</b>           |                 |           |                   |                 |           |       |   |       |           |     |       |   |      |   |       |
| 540-170-1344           | FM1969          | BRONZE    | SPR/RAD           | 38              | INT TH    | 243.0 | x | 185.0 | x         | 3.8 | 9.57  | x | 7.28 | x | 0.15  |
| 540-170-1352           | FM1962MP        | STEEL     | -----             | 14              | EXT LG    | 265.5 | x | 197.5 | x         | 2.6 | 10.45 | x | 7.78 | x | 0.102 |
| 7548-1711482           | FM1994MP        | STEEL     | -----             | 50              | EXT TH    | 255.0 | x | 198.6 | x         | 2.6 | 10.04 | x | 7.82 | x | 0.102 |
| <b>BALKANCAR</b>       |                 |           |                   |                 |           |       |   |       |           |     |       |   |      |   |       |
| KTM1189                | FM4051          | BRONZE    | WAFFLE            | 35              | INT TH    | 146.0 | x | 102.6 | x         | 2.5 | 5.75  | x | 4.04 | x | 0.098 |
| KTM1490                | FM4045          | BRONZE    | SPIRAL            | 34              | INT TH    | 132.0 | x | 83.0  | x         | 2.0 | 5.2   | x | 3.27 | x | 0.079 |
| KTM1942                | FM4045          | BRONZE    | SPIRAL            | 34              | INT TH    | 132.0 | x | 83.0  | x         | 2.0 | 5.2   | x | 3.27 | x | 0.079 |
| 6844.01.00.05          | FM4054MP        | STEEL     | -----             | 50              | EXT TH    | 152.6 | x | 109.0 | x         | 2.0 | 6     | x | 4.29 | x | 0.079 |
| 6855.02.00.06          | FM4048MP        | STEEL     | -----             | 45              | EXT TH    | 139.3 | x | 90.0  | x         | 1.5 | 5.48  | x | 3.54 | x | 0.059 |
| 6855.02.00.07          | FM4048MP        | STEEL     | -----             | 45              | EXT TH    | 139.3 | x | 90.0  | x         | 1.5 | 5.48  | x | 3.54 | x | 0.059 |
| <b>J C BAMFORD</b>     |                 |           |                   |                 |           |       |   |       |           |     |       |   |      |   |       |
| 04/500206              | FM3571          | PAPER     | 2 PASS            | 59              | INT TH    | 190.8 | x | 147.3 | x         | 3.0 | 7.51  | x | 5.8  | x | 0.118 |
| 04/500207              | FM1938MP        | STEEL     | -----             | 3               | EXT LG    | 214.9 | x | 155.7 | x         | 1.8 | 8.46  | x | 6.13 | x | 0.07  |
| 04/500229              | FM5452MP        | STEEL     | END PLATE         | 54              | EXT TH    | 139.2 | x | 98.2  | x         | 8.7 | 5.48  | x | 3.87 | x | 0.343 |
| 04/500230              | FM1649          | TAN PAPER | 2 PASS            | 45              | INT TH    | 133.1 | x | 92.7  | x         | 1.6 | 5.24  | x | 3.65 | x | 0.063 |
| 04/500230              | FM1649R         | GREEN PA. | WAFFLE            | 45              | INT TH    | 133.1 | x | 92.7  | x         | 1.6 | 5.24  | x | 3.65 | x | 0.063 |
| 04/500231              | FM1324MP        | STEEL     | -----             | 54              | EXT TH    | 139.2 | x | 98.6  | x         | 1.8 | 5.48  | x | 3.88 | x | 0.07  |
| 04/500233              | FM5442MP        | STEEL     | END PLATE         | 54              | EXT TH    | 139.2 | x | 98.2  | x         | 8.3 | 5.48  | x | 3.87 | x | 0.327 |
| 04/500235              | FM4222SP        | STEEL     | SPRING            | 8               | INT TH    | 134.7 | x | 73.6  | x         | 1.8 | 5.3   | x | 2.9  | x | 0.071 |
| 04/500300              | FM3382KIT       | STEEL     | FLEXI PLATE       |                 |           |       |   |       |           |     |       |   |      |   |       |
| 04/500301              | FM3382FP        | STEEL     | FLEXI PLATE       | 6               | HOLE      | 339.7 | x | 133.4 | x         | 1.5 | 13.37 | x | 5.25 | x | 0.059 |
| 04/500302              | FM4442FP        | STEEL     | REINF PLATE       | 6               | HOLE      | 186.5 | x | 132.0 | x         | 2.1 | 7.34  | x | 5.2  | x | 0.083 |
| 04/800278              | FM2277          | BRONZE    | SUNBURST          | 27              | EXT TH    | 137.4 | x | 90.9  | x         | 2.0 | 5.41  | x | 3.58 | x | 0.079 |
| 04/800279              | FM3592MP        | STEEL     | -----             | 29              | INT TH    | 131.1 | x | 85.1  | x         | 1.5 | 5.16  | x | 3.35 | x | 0.059 |
| 04/800280              | FM3594MP        | STEEL     | -----             | 29              | INT TH    | 131.1 | x | 85.1  | x         | 2.0 | 5.16  | x | 3.35 | x | 0.079 |
| 04/800281              | FM3596MP        | STEEL     | -----             | 29              | INT TH    | 131.1 | x | 85.1  | x         | 2.5 | 5.16  | x | 3.35 | x | 0.098 |
| 04/700745              | FM3596MP        | STEEL     | -----             | 29              | INT TH    | 131.1 | x | 85.1  | x         | 2.5 | 5.16  | x | 3.35 | x | 0.098 |
| 04/800746              | FM2277          | BRONZE    | SUNBURST          | 27              | EXT TH    | 137.4 | x | 90.9  | x         | 2.0 | 5.41  | x | 3.58 | x | 0.079 |
| 05/901906              | FM7638MP        | STEEL     | -----             | 27              | INT TH    | 107.2 | x | 78.7  | x         | 1.5 | 4.22  | x | 3.1  | x | 0.059 |
| 05/901907              | FM7635          | BRONZE    | WAFFLE            | 37              | EXT TH    | 113.8 | x | 85.0  | x         | 2.2 | 4.48  | x | 3.35 | x | 0.087 |
| 10/300200              | FM2995          | PAPER     | 2 PASS            | 54              | INT TH    | 325.0 | x | 224.0 | x         | 4.5 | 12.8  | x | 8.82 | x | 0.177 |
| 10/300376              | FM2991          | PAPER     | 3 PASS            | 57              | INT TH    | 360.0 | x | 237.0 | x         | 4.5 | 14.17 | x | 9.33 | x | 0.177 |
| 10/300377              | FM3620MP        | STEEL     | -----             | 75              | EXT TH    | 383.0 | x | 253.0 | x         | 3.9 | 15.08 | x | 9.96 | x | 0.154 |
| 10/300378              | FM3622MP        | STEEL     | -----             | 75              | EXT TH    | 383.0 | x | 253.0 | x         | 4.3 | 15.08 | x | 9.96 | x | 0.167 |
| 10/301378              | FM3626MP        | STEEL     | -----             | 75              | EXT TH    | 383.0 | x | 253.0 | x         | 5.0 | 15.08 | x | 9.96 | x | 0.197 |
| 10/904181              | FM2890MP        | STEEL     | -----             | 3               | EXT LG    | 180.0 | x | 111.0 | x         | 2.7 | 7.09  | x | 4.37 | x | 0.105 |
| 10/904182              | FM2715          | PAPER     | 2 PASS            | 19              | INT TH    | 152.0 | x | 34.0  | x         | 4.8 | 5.98  | x | 1.34 | x | 0.189 |
| 10/904323              | FM3608MP        | STEEL     | -----             | 88              | (91)EX TH | 293.0 | x | 185.0 | x         | 4.5 | 11.54 | x | 7.28 | x | 0.177 |
| 10/904336              | FM3606MP        | STEEL     | -----             | 88              | (91)EX TH | 293.0 | x | 185.0 | x         | 4.0 | 11.54 | x | 7.28 | x | 0.157 |
| 10/904337              | FM2811          | PAPER     | 4 PASS            | 34              | INT TH    | 277.0 | x | 167.0 | x         | 4.5 | 10.91 | x | 6.57 | x | 0.177 |
| 10/905026              | FM3606MP        | STEEL     | -----             | 88              | (91)EX TH | 293.0 | x | 185.0 | x         | 4.0 | 11.54 | x | 7.28 | x | 0.157 |
| 10/905027              | FM2811          | PAPER     | 4 PASS            | 34              | INT TH    | 277.0 | x | 167.0 | x         | 4.5 | 10.91 | x | 6.57 | x | 0.177 |
| 10/905028              | FM3608MP        | STEEL     | -----             | 88              | (91)EX TH | 293.0 | x | 185.0 | x         | 4.5 | 11.54 | x | 7.28 | x | 0.177 |
| 10/905029              | FM3606MP        | STEEL     | -----             | 88              | (91)EX TH | 293.0 | x | 185.0 | x         | 4.0 | 11.54 | x | 7.28 | x | 0.157 |

| REPLACES<br>OEM PT.NO. | FMC<br>PART NO. | MATERIAL | GROOVE<br>DETAILS | TEETH/<br>TANGS | SIZE MM   |       |   | SIZE INCH |   |     |       |   |       |   |       |
|------------------------|-----------------|----------|-------------------|-----------------|-----------|-------|---|-----------|---|-----|-------|---|-------|---|-------|
| 10/905030              | FM3608MP        | STEEL    | -----             | 88              | (91)EX TH | 293.0 | x | 185.0     | x | 4.5 | 11.54 | x | 7.28  | x | 0.177 |
| 10/905043              | FM2811          | PAPER    | 4 PASS            | 34              | INT TH    | 277.0 | x | 167.0     | x | 4.5 | 10.91 | x | 6.57  | x | 0.177 |
| 10/905514              | FM2969          | BRONZE   | WAFFLE            | 22              | INT TH    | 71.7  | x | 44.0      | x | 1.6 | 2.82  | x | 1.73  | x | 0.063 |
| 10/906320              | FM9485          | GRAPHITE | SUNBURST          | 12              | INT TH    | 170.0 | x | 32.7      | x | 4.8 | 6.69  | x | 1.29  | x | 0.189 |
| 10/906486              | FM2997          | PAPER    | 2 PASS            | 72              | INT TH    | 298.0 | x | 215.0     | x | 4.5 | 11.73 | x | 8.46  | x | 0.177 |
| 10/906487              | FM3640MP        | STEEL    | -----             | 75              | EXT TH    | 315.0 | x | 226.0     | x | 3.9 | 12.4  | x | 8.9   | x | 0.154 |
| 10/906488              | FM3644MP        | STEEL    | -----             | 75              | EXT TH    | 315.0 | x | 226.0     | x | 4.5 | 12.4  | x | 8.9   | x | 0.177 |
| 10/906489              | FM3642MP        | STEEL    | -----             | 75              | EXT TH    | 315.0 | x | 226.0     | x | 4.3 | 12.4  | x | 8.9   | x | 0.167 |
| 10/906490              | FM3646MP        | STEEL    | -----             | 75              | EXT TH    | 315.0 | x | 226.0     | x | 5.0 | 12.4  | x | 8.9   | x | 0.197 |
| 10/906586              | FM2995          | PAPER    | 2 PASS            | 54              | INT TH    | 325.0 | x | 224.0     | x | 4.5 | 12.8  | x | 8.82  | x | 0.177 |
| 10/906587              | FM3630MP        | STEEL    | -----             | 75              | EXT TH    | 345.0 | x | 243.0     | x | 3.9 | 13.58 | x | 9.57  | x | 0.154 |
| 10/906588              | FM3634MP        | STEEL    | -----             | 75              | EXT TH    | 345.0 | x | 243.0     | x | 4.5 | 13.58 | x | 9.57  | x | 0.177 |
| 10/906589              | FM3636MP        | STEEL    | -----             | 75              | EXT TH    | 345.0 | x | 243.0     | x | 5.0 | 13.58 | x | 9.57  | x | 0.197 |
| 10/906590              | FM3632MP        | STEEL    | -----             | 75              | EXT TH    | 345.0 | x | 243.0     | x | 4.2 | 13.58 | x | 9.57  | x | 0.165 |
| 10/906812              | FM3575          | PAPER    | 3 PASS            | 35              | INT TH    | 179.0 | x | 103.0     | x | 3.5 | 7.05  | x | 4.05  | x | 0.138 |
| 10/906931              | FM4844MP        | STEEL    | -----             | 67              | (70)EX TH | 191.0 | x | 130.0     | x | 2.0 | 7.52  | x | 5.12  | x | 0.079 |
| 10/906932              | FM3948MP        | STEEL    | -----             | 67              | (70)EX TH | 191.0 | x | 130.0     | x | 2.5 | 7.52  | x | 5.12  | x | 0.098 |
| 10/906933              | FM3946MP        | STEEL    | -----             | 67              | (70)EX TH | 191.0 | x | 130.0     | x | 3.0 | 7.52  | x | 5.12  | x | 0.118 |
| 10/907119              | FM4844MP        | STEEL    | -----             | 67              | (70)EX TH | 191.0 | x | 130.0     | x | 2.0 | 7.52  | x | 5.12  | x | 0.079 |
| 10/907120              | FM3948MP        | STEEL    | -----             | 67              | (70)EX TH | 191.0 | x | 130.0     | x | 2.5 | 7.52  | x | 5.12  | x | 0.098 |
| 10/907121              | FM3946MP        | STEEL    | -----             | 67              | (70)EX TH | 191.0 | x | 130.0     | x | 3.0 | 7.52  | x | 5.12  | x | 0.118 |
| 10/907122              | FM3575          | PAPER    | 3 PASS            | 35              | INT TH    | 179.0 | x | 103.0     | x | 3.5 | 7.05  | x | 4.05  | x | 0.138 |
| 10/907369              | FM4650MP        | STEEL    | -----             | 24              | EXT TH    | 108.2 | x | 76.2      | x | 1.2 | 4.26  | x | 3.0   | x | 0.045 |
| 10/907373              | FM4647          | BRONZE   | SPR/RAD           | 34              | INT TH    | 100.0 | x | 68.2      | x | 1.6 | 3.94  | x | 2.69  | x | 0.061 |
| 15/920147              | FM2997          | PAPER    | 2 PASS            | 72              | INT TH    | 298.0 | x | 215.0     | x | 4.5 | 11.73 | x | 8.46  | x | 0.177 |
| 200/42308P             | FM1288MP        | STEEL    | -----             | 79              | EXT TH    | 168.7 | x | 104.1     | x | 1.5 | 6.64  | x | 4.1   | x | 0.059 |
| 200/42309P             | FM0177          | BRONZE   | SUNBURST          | 38              | INT TH    | 163.3 | x | 92.7      | x | 2.4 | 6.43  | x | 3.65  | x | 0.095 |
| 200/42311              | FM0177          | BRONZE   | SUNBURST          | 38              | INT TH    | 163.3 | x | 92.7      | x | 2.5 | 6.43  | x | 3.65  | x | 0.098 |
| 331/16516              | FM5122MP        | STEEL    | -----             | 57              | EXT TH    | 147.2 | x | 99.5      | x | 2.0 | 5.8   | x | 3.92  | x | 0.079 |
| 331/16519              | FM8152MP        | STEEL    | -----             | 57              | EXT TH    | 147.2 | x | 99.5      | x | 1.2 | 5.8   | x | 3.92  | x | 0.047 |
| 331/16520              | FM5119          | PAPER    | RADIAL            | 45              | INT TH    | 140.2 | x | 92.4      | x | 2.4 | 5.52  | x | 3.64  | x | 0.094 |
| 331/31560              | FM3656MP        | STEEL    | -----             | 54              | EXT TH    | 139.0 | x | 99.0      | x | 4.0 | 5.47  | x | 3.9   | x | 0.157 |
| 331/31561              | FM6706MP        | STEEL    | -----             | 54              | EXT TH    | 139.0 | x | 90.0      | x | 6.0 | 5.47  | x | 3.54  | x | 0.236 |
| 331/31563              | FM7286MP        | OBSOLETE | -----             | 54              | EXT TH    | 139.0 | x | 99.0      | x | 6.5 | 5.47  | x | 3.9   | x | 0.256 |
| 332/C4679              | FM8049          | BRONZE   | WAF/WAG           | 34              | INT TH    | 104.0 | x | 68.0      | x | 1.6 | 4.09  | x | 2.68  | x | 0.063 |
| 332/C4680              | FM8188MP        | STEEL    | HARDENED          | 45              | EXT TH    | 111.2 | x | 84.2      | x | 1.4 | 4.38  | x | 3.31  | x | 0.055 |
| 332/F6082              | FM6417          | BRONZE   | WAF/WAG           | 64              | INT TH    | 345.0 | x | 252.0     | x | 3.8 | 13.58 | x | 9.92  | x | 0.15  |
| 332/G0484              | FM6454MP        | STEEL    | HARDENED          | 20              | EXT LG    | 374.0 | x | 262.0     | x | 2.4 | 14.72 | x | 10.31 | x | 0.094 |
| 332/Y8132              | FM5122MP        | STEEL    | -----             | 57              | EXT TH    | 147.2 | x | 99.5      | x | 2.0 | 5.8   | x | 3.92  | x | 0.079 |
| 332/Y8134              | FM3878MP        | STEEL    | -----             | 3               | EXT LG    | 240.0 | x | 140.0     | x | 3.8 | 9.45  | x | 5.51  | x | 0.15  |
| 333/C5794              | FM4183          | PAPER    | WAF/WAG           | 64              | INT TH    | 345.0 | x | 252.1     | x | 4.7 | 13.58 | x | 9.93  | x | 0.185 |
| 333/C5795              | FM4186MP        | STEEL    | -----             | 20              | EXT LG    | 372.5 | x | 262.5     | x | 4.0 | 14.67 | x | 10.33 | x | 0.157 |
| 333/C5805              | FM5572MP        | STEEL    | -----             | 20              | EXT LG    | 372.5 | x | 262.5     | x | 2.0 | 14.67 | x | 10.33 | x | 0.079 |
| 333/D1602              | FM6127          | PAPER    | WAFFLE            | 24              | INT TH    | 253.0 | x | 69.0      | x | 6.1 | 9.96  | x | 2.72  | x | 0.24  |
| 333/D1603              | FM6130MP        | STEEL    | -----             | 3               | EXT LG    | 268.0 | x | 176.0     | x | 4.5 | 10.55 | x | 6.93  | x | 0.177 |
| 440/00707              | FM3110MP        | STEEL    | -----             | 9               | EXT TH    | 180.4 | x | 80.0      | x | 3.2 | 7.1   | x | 3.15  | x | 0.126 |
| 440/00719              | FM3105          | PAPER    | 2 PASS            | 16              | INT TH    | 164.0 | x | 34.2      | x | 3.8 | 6.46  | x | 1.35  | x | 0.15  |

| REPLACES<br>OEM PT.NO. | FMC<br>PART NO. | MATERIAL             | GROOVE<br>DETAILS | TEETH/<br>TANGS | SIZE MM   | SIZE INCH                               |
|------------------------|-----------------|----------------------|-------------------|-----------------|-----------|---|
| 440/00720              | FM3108MP        | STEEL                | -----             | 9               | EXT TH    | 180.4 x 80.0 x 3.8 7.1 x 3.15 x 0.15    |
| 440/00721              | FM3105          | PAPER                | 2 PASS            | 16              | INT TH    | 164.0 x 34.2 x 3.8 6.46 x 1.35 x 0.15   |
| 445/03205              | FM1649KIT       | KIT(7)               | 2 PASS            | 45              | INT TH    | 133.1 x 92.7 x 1.6 5.24 x 3.65 x 0.063  |
| 445/03206              | FM2160KIT       | KIT(6)               | -----             | 6               | EXT LG    | 150.9 x 98.6 x 1.8 5.94 x 3.88 x 0.07   |
| 445/03206              | FM2160MP        | SINGLE               | PLATE             | 6               | EXT LG    | 150.9 x 98.6 x 1.8 5.94 x 3.88 x 0.07   |
| 445/05106              | FM3845          | BRONZE               | WAFFLE            | 28              | INT TH    | 101.5 x 57.2 x 2.1 4.0 x 2.25 x 0.083   |
| 445/05107              | FM3848MP        | STEEL                | -----             | 6               | EXT LG    | 111.5 x 66.7 x 1.5 4.39 x 2.63 x 0.059  |
| 445/12307              | FM1324MP        | STEEL                | -----             | 54              | EXT TH    | 139.2 x 98.6 x 1.8 5.48 x 3.88 x 0.07   |
| 445/12314              | FM3654MP        | STEEL                | -----             | 54              | EXT TH    | 139.2 x 98.6 x 1.2 5.48 x 3.88 x 0.049  |
| 445/12315              | FM6860MP        | END PLATE            | -----             | 18              | (54)EX TH | 139.0 x 98.0 x 6.0 5.47 x 3.86 x 0.236  |
| 445/30011              | FM2983          | GREEN PA.            | 2 PASS            | 45              | INT TH    | 133.1 x 92.7 x 2.3 5.24 x 3.65 x 0.091  |
| 445/30011              | FM3873          | TAN PAPER            | 2 PASS            | 45              | INT TH    | 133.1 x 92.7 x 2.3 5.24 x 3.65 x 0.091  |
| 445/40118              | FM4570MP        | STEEL                | -----             | 3               | EXT LG    | 115.0 x 74.0 x 1.5 4.53 x 2.91 x 0.059  |
| 445/40119              | FM4567          | BRONZE               | -----             | 15              | INT TH    | 101.8 x 29.8 x 2.1 4.0 x 1.17 x 0.083   |
| 446/01310              | FM1304MP        | STEEL                | -----             | 40              | (52)EX TH | 170.9 x 130.3 x 1.4 6.73 x 5.13 x 0.055 |
| 446/01317              | FM0541          | BRONZE               | SUNBURST          | 38              | INT TH    | 162.6 x 120.9 x 2.3 6.4 x 4.76 x 0.09   |
| 446/01317              | FM0855          | OBSOLETE AFTER STOCK |                   | 38              | INT TH    | 162.6 x 120.9 x 2.3 6.4 x 4.76 x 0.09   |
| 446/40707              | FM0851          | OBSOLETE             | SUNBURST          | 51              | EXT TH    | 165.1 x 127.0 x 2.4 6.5 x 5.0 x 0.095   |
| 447/00506              | FM1389          | BRONZE               | SPIRAL            | 57              | INT TH    | 128.3 x 87.9 x 2.5 5.05 x 3.46 x 0.098  |
| 447/00507              | FM1302MP        | STEEL                | -----             | 64              | EXT TH    | 137.2 x 96.3 x 1.5 5.4 x 3.79 x 0.059   |
| 447/06706              | FM1288MP        | STEEL                | -----             | 79              | EXT TH    | 168.7 x 104.1 x 1.5 6.64 x 4.1 x 0.059  |
| 450/10211              | FM2209          | BRONZE               | SPR/WAG           | 15              | INT TH    | 221.0 x 49.5 x 4.8 8.7 x 1.95 x 0.189   |
| 450/10212              | FM2212MP        | STEEL                | -----             | 3               | EXT LG    | 238.0 x 140.0 x 3.2 9.37 x 5.51 x 0.125 |
| 450/10218              | FM2209          | USE 450/10211        |                   |                 |           |   |
| 450/10219              | FM2212MP        | STEEL                | -----             | 3               | EXT LG    | 238.0 x 140.0 x 3.2 9.37 x 5.51 x 0.125 |
| 450/10224              | FM3875          | PAPER                | 3 PASS            | 15              | INT TH    | 222.0 x 49.5 x 3.9 8.74 x 1.95 x 0.152  |
| 450/10226              | FM3878MP        | STEEL                | -----             | 3               | EXT LG    | 240.0 x 140.0 x 3.8 9.45 x 5.51 x 0.15  |
| 450/20401              | FM4539          | BRONZE               | -----             | 28              | INT TH    | 88.0 x 57.3 x 3.0 3.46 x 2.25 x 0.118   |
| 450/20402              | FM4537          | BRONZE               | -----             | 28              | INT TH    | 88.0 x 57.3 x 2.1 3.46 x 2.25 x 0.08    |
| 450/20403              | FM4476MP        | STEEL                | -----             | 4               | EXT LG    | 98.7 x 63.0 x 1.6 3.89 x 2.48 x 0.063   |
| 450/22908              | FM4975          | PAPER                | 3 PASS            | 24              | INT TH    | 222.0 x 58.5 x 3.9 8.74 x 2.3 x 0.154   |
| 450/23003              | FM4975          | PAPER                | 3 PASS            | 24              | INT TH    | 222.0 x 58.5 x 3.9 8.74 x 2.3 x 0.154   |
| 451/01702              | FM1595          | BRONZE               | SPR/WAG           | 23              | INT TH    | 203.2 x 46.2 x 4.7 8.0 x 1.82 x 0.185   |
| 451/01703              | FM2446MP        | STEEL                | -----             | 4               | EXT LG    | 229.9 x 130.0 x 2.3 9.05 x 5.12 x 0.09  |
| 451/08002              | FM1598MP        | STEEL                | -----             | 4               | EXT LG    | 229.9 x 130.0 x 2.3 9.05 x 5.12 x 0.09  |
| 451/13302              | FM1598MP        | STEEL                | -----             | 4               | EXT LG    | 229.9 x 130.0 x 2.3 9.05 x 5.12 x 0.09  |
| 451/13303              | FM1595          | BRONZE               | SPR/WAG           | 23              | INT TH    | 203.2 x 46.2 x 4.7 8.0 x 1.82 x 0.185   |
| 451/22702              | FM2116MP        | STEEL                | -----             | 4               | EXT LG    | 229.9 x 130.0 x 3.1 9.05 x 5.12 x 0.124 |
| 451/24201              | FM2116MP        | STEEL                | -----             | 4               | EXT LG    | 229.9 x 130.0 x 3.1 9.05 x 5.12 x 0.124 |
| 451/24202              | FM2116MP        | STEEL                | -----             | 4               | EXT LG    | 229.9 x 130.0 x 3.1 9.05 x 5.12 x 0.124 |
| 453/15301              | FM4248MP        | STEEL                | -----             | 9               | (60)EX TH | 240.0 x 130.0 x 3.8 9.45 x 5.12 x 0.15  |
| 456/01001              | FM8905          | PAPER                | 2 PASS/SINEWAVE   | 45              | INT TH    | 133.3 x 92.7 x 2.3 5.25 x 3.65 x 0.091  |
| 458/20281              | FM3105          | PAPER                | 2 PASS            | 16              | INT TH    | 164.0 x 34.2 x 3.8 6.46 x 1.35 x 0.15   |
| 458/20285              | FM3878MP        | STEEL                | -----             | 3               | EXT LG    | 240.0 x 140.0 x 3.8 9.45 x 5.51 x 0.15  |
| 458/20286              | FM3108MP        | STEEL                | -----             | 9               | EXT TH    | 180.4 x 80.0 x 3.8 7.1 x 3.15 x 0.15    |
| 458/20289              | FM4248MP        | STEEL                | -----             | 9               | (60)EX TH | 240.0 x 130.0 x 3.8 9.45 x 5.12 x 0.15  |
| 458/20316              | FM4975          | PAPER                | 3 PASS            | 24              | INT TH    | 222.0 x 58.5 x 3.9 8.74 x 2.3 x 0.154   |
| 458/20353              | FM3875          | PAPER                | 3 PASS            | 15              | INT TH    | 222.0 x 49.5 x 3.9 8.74 x 1.95 x 0.152  |



# Bell Transmission Diff Discs





| REPLACES<br>OEM PT.NO.            | FMC<br>PART NO. | MATERIAL   | GROOVE<br>DETAILS | TEETH/<br>TANGS | SIZE MM   |       |   | SIZE INCH |   |     |       |   |       |   |       |
|-----------------------------------|-----------------|------------|-------------------|-----------------|-----------|-------|---|-----------|---|-----|-------|---|-------|---|-------|
| 458/20357                         | FM5065          | PAPER      | 3 PASS            | 15              | INT TH    | 166.0 | x | 49.5      | x | 3.9 | 6.54  | x | 1.95  | x | 0.153 |
| 458/20358                         | FM5068MP        | STEEL      | -----             | 3               | EXT LG    | 182.0 | x | 97.0      | x | 3.9 | 7.17  | x | 3.82  | x | 0.153 |
| 550/43098                         | FM2997          | PAPER      | 2 PASS            | 72              | INT TH    | 298.0 | x | 215.0     | x | 4.5 | 11.73 | x | 8.46  | x | 0.177 |
| 550/43099                         | FM3640MP        | STEEL      | -----             | 75              | EXT TH    | 315.0 | x | 226.0     | x | 3.9 | 12.4  | x | 8.9   | x | 0.154 |
| 550/43100                         | FM3644MP        | STEEL      | -----             | 75              | EXT TH    | 315.0 | x | 226.0     | x | 4.5 | 12.4  | x | 8.9   | x | 0.177 |
| 550/43101                         | FM3646MP        | STEEL      | -----             | 75              | EXT TH    | 315.0 | x | 226.0     | x | 5.0 | 12.4  | x | 8.9   | x | 0.197 |
| 550/43103                         | FM3642MP        | STEEL      | -----             | 75              | EXT TH    | 315.0 | x | 226.0     | x | 4.3 | 12.4  | x | 8.9   | x | 0.167 |
| 814/00207                         | FM4222SP        | STEEL      | SPRING            | 8               | INT TH    | 134.7 | x | 73.6      | x | 1.8 | 5.3   | x | 2.9   | x | 0.071 |
| 998/M5385                         | FM7913KIT       | 12 X PAPER | 12 X STEEL        |                 |           |       |   |           |   |     |       |   |       |   |       |
| LMM0336                           | FM9190MP        | STEEL      | -----             | 16              | EXT TH    | 173.5 | x | 143.0     | x | 1.6 | 6.83  | x | 5.63  | x | 0.063 |
| LMM0337                           | FM9187          | PAPER      | WAFFLE            | 54              | INT TH    | 164.0 | x | 136.0     | x | 3.0 | 6.46  | x | 5.35  | x | 0.118 |
| <b>BELL (ALSO SEE JOHN DEERE)</b> |                 |            |                   |                 |           |       |   |           |   |     |       |   |       |   |       |
| 160234                            | FM9012-2.9      | STEEL      | HARDENED          | 4               | EXT LG    | 164.8 | x | 82.4      | x | 2.9 | 6.49  | x | 4.24  | x | 0.114 |
| 160235                            | FM9012-3.0      | STEEL      | HARDENED          | 4               | EXT LG    | 164.8 | x | 82.4      | x | 3.0 | 6.49  | x | 4.24  | x | 0.118 |
| 160236                            | FM9012-3.1      | STEEL      | HARDENED          | 4               | EXT LG    | 164.8 | x | 82.4      | x | 3.1 | 6.49  | x | 4.24  | x | 0.122 |
| 160238                            | FM4449          | MOLYBDENUM | SPR/WAG           | 26              | INT TH    | 147.8 | x | 75.4      | x | 3.0 | 5.82  | x | 2.97  | x | 0.118 |
| 200053                            | FM5250-3.0      | STEEL      | HARDENED          | 4               | EXT LG    | 189.8 | x | 92.1      | x | 3.0 | 7.47  | x | 3.63  | x | 0.118 |
| 200054                            | FM5250-2.9      | STEEL      | HARDENED          | 4               | EXT LG    | 189.8 | x | 92.1      | x | 2.9 | 7.47  | x | 3.63  | x | 0.114 |
| 200055                            | FM5250-3.1      | STEEL      | HARDENED          | 4               | EXT LG    | 189.8 | x | 92.1      | x | 3.1 | 7.47  | x | 3.63  | x | 0.122 |
| 200056                            | FM5250-2.7      | STEEL      | HARDENED          | 4               | EXT LG    | 189.8 | x | 92.1      | x | 2.7 | 7.47  | x | 3.63  | x | 0.106 |
| 200057                            | FM5250-3.3      | STEEL      | HARDENED          | 4               | EXT LG    | 189.8 | x | 92.1      | x | 3.3 | 7.47  | x | 3.63  | x | 0.13  |
| 200058                            | FM5247          | MOLYBDENUM | SPR/WAG           | 40              | INT TH    | 172.0 | x | 84.1      | x | 3.0 | 6.77  | x | 3.31  | x | 0.118 |
| 200106                            | FM4666-2.2      | STEEL      | HARDENED          | 6               | EXT SL    | 130.0 | x | 66.8      | x | 2.2 | 5.12  | x | 2.63  | x | 0.087 |
| 200107                            | FM4666MP        | STEEL      | HARDENED          | 6               | EXT SL    | 130.0 | x | 66.8      | x | 2.3 | 5.12  | x | 2.63  | x | 0.091 |
| 200108                            | FM4666-2.4      | STEEL      | HARDENED          | 6               | EXT SL    | 130.0 | x | 66.8      | x | 2.4 | 5.12  | x | 2.63  | x | 0.094 |
| 200109                            | FM4666-2.5      | STEEL      | HARDENED          | 6               | EXT SL    | 130.0 | x | 66.8      | x | 2.5 | 5.12  | x | 2.63  | x | 0.098 |
| 200111                            | FM4451          | MOLYBDENUM | SPR/WAG           | 46              | (50)IN TH | 117.5 | x | 62.6      | x | 2.6 | 4.63  | x | 2.46  | x | 0.102 |
| 207666                            | FM7707          | BRONZE     | SUN/RAD           | 60              | INT TH    | 462.4 | x | 299.4     | x | 4.9 | 18.2  | x | 11.79 | x | 0.193 |
| 208496                            | FM7710MP        | STEEL      | -----             | 94              | EXT TH    | 486.7 | x | 318.3     | x | 4.0 | 19.16 | x | 12.53 | x | 0.157 |
| 208662                            | FM7707          | BRONZE     | SUN/RAD           | 60              | INT TH    | 462.4 | x | 299.4     | x | 4.9 | 18.2  | x | 11.79 | x | 0.193 |
| 217103                            | FM8253          | BRONZE     | SPR/RAD           | 20              | INT TH    | 150.0 | x | 74.8      | x | 4.0 | 5.91  | x | 2.94  | x | 0.157 |
| 217104                            | FM8256MP        | STEEL      | HARDENED          | 6               | EXT SL    | 163.9 | x | 86.0      | x | 4.0 | 6.45  | x | 3.39  | x | 0.157 |
| 220712                            | FM6726MP        | STEEL      | -----             | 2               | EXT LG    | 151.3 | x | 61.0      | x | 6.3 | 5.97  | x | 2.4   | x | 0.248 |
| 220713                            | FM6721          | PAPER      | 2 PASS            | 42              | INT TH    | 90.3  | x | 52.2      | x | 2.6 | 3.56  | x | 2.05  | x | 0.1   |
| 220714                            | FM6724MP        | STEEL      | -----             | 2               | EXT LG    | 151.8 | x | 60.7      | x | 1.9 | 5.98  | x | 2.39  | x | 0.075 |
| 221014                            | FM8216MP        | STEEL      | HARDENED          | 2               | EXT LG    | 275.0 | x | 123.9     | x | 1.8 | 10.83 | x | 4.88  | x | 0.069 |
| 221015                            | FM8213          | MOLYBDENUM | SPR/RAD           | 27              | INT TH    | 246.5 | x | 114.3     | x | 1.7 | 9.7   | x | 4.5   | x | 0.067 |
| 221456                            | FM3167          | GRAPHITE   | WAFFLE            | 60              | INT TH    | 450.0 | x | 300.0     | x | 5.3 | 17.72 | x | 11.81 | x | 0.209 |
| 221457                            | FM7768MP        | STEEL      | -----             |                 | RING      | 449.0 | x | 329.0     | x | 6.6 | 17.68 | x | 12.95 | x | 0.258 |
| 224967                            | FM4642MP        | STEEL      | -----             | 72              | (90)EX TH | 462.0 | x | 350.0     | x | 5.0 | 18.19 | x | 13.78 | x | 0.197 |
| 226813                            | FM3167          | GRAPHITE   | WAFFLE            | 60              | INT TH    | 450.0 | x | 300.0     | x | 5.3 | 17.72 | x | 11.81 | x | 0.209 |

| REPLACES<br>OEM PT.NO. | FMC<br>PART NO. | MATERIAL  | GROOVE<br>DETAILS | TEETH/<br>TANGS | SIZE MM |       |   |       | SIZE INCH |      |       |   |       |   |       |
|------------------------|-----------------|-----------|-------------------|-----------------|---------|-------|---|-------|-----------|------|-------|---|-------|---|-------|
| <b>BENATI</b>          |                 |           |                   |                 |         |       |   |       |           |      |       |   |       |   |       |
| 321 2112               | FM1216MP        | STEEL     | -----             | 60              | EXT TH  | 154.2 | x | 113.8 | x         | 1.8  | 6.07  | x | 4.48  | x | 0.07  |
| 321 2326               | FM1305OE        | BRONZE    | RADIAL            | 52              | INT TH  | 148.6 | x | 107.7 | x         | 2.6  | 5.85  | x | 4.24  | x | 0.102 |
| 321 3587               | FM1324MP        | STEEL     | -----             | 54              | EXT TH  | 139.2 | x | 98.6  | x         | 1.8  | 5.48  | x | 3.88  | x | 0.07  |
| 321 3743               | FM1375OE        | BRONZE    | RADIAL            | 45              | INT TH  | 133.1 | x | 92.7  | x         | 2.4  | 5.24  | x | 3.65  | x | 0.093 |
| 321 3744               | FM1375OE        | BRONZE    | RADIAL            | 45              | INT TH  | 133.1 | x | 92.7  | x         | 2.4  | 5.24  | x | 3.65  | x | 0.093 |
| 321 3793               | FM1305OE        | BRONZE    | RADIAL            | 52              | INT TH  | 148.6 | x | 107.7 | x         | 2.6  | 5.85  | x | 4.24  | x | 0.102 |
| 324 2311               | FM2279          | BRONZE    | SUNBURST          | 35              | EXT TH  | 177.5 | x | 109.0 | x         | 2.0  | 6.99  | x | 4.29  | x | 0.079 |
| 324 2312               | FM3602MP        | STEEL     | -----             | 35              | INT TH  | 170.9 | x | 102.9 | x         | 2.0  | 6.73  | x | 4.05  | x | 0.079 |
| 324 2313               | FM3604MP        | STEEL     | -----             | 35              | INT TH  | 170.9 | x | 102.9 | x         | 2.5  | 6.73  | x | 4.05  | x | 0.098 |
| 324 2336               | FM2277          | BRONZE    | SUNBURST          | 27              | EXT TH  | 137.4 | x | 90.9  | x         | 2.0  | 5.41  | x | 3.58  | x | 0.079 |
| 324 2401               | FM3021          | BRONZE    | SUNBURST          | 87              | INT TH  | 306.0 | x | 258.0 | x         | 3.0  | 12.05 | x | 10.16 | x | 0.118 |
| 324 2402               | FM3024MP        | STEEL     | -----             | 12              | EXT LG  | 317.7 | x | 268.0 | x         | 3.0  | 12.51 | x | 10.55 | x | 0.118 |
| 324 2677               | FM3024MP        | STEEL     | -----             | 12              | EXT LG  | 317.7 | x | 268.0 | x         | 3.0  | 12.51 | x | 10.55 | x | 0.118 |
| 3326442                | FM5797          | CARBON PA | SUNBURST          | 27              | INT TH  | 255.0 | x | 66.1  | x         | 10.0 | 10.04 | x | 2.6   | x | 0.394 |
| 3326606                | FM4015          | GRAPHITE  | SUNBURST          | 27              | INT TH  | 303.8 | x | 66.1  | x         | 10.0 | 11.96 | x | 2.6   | x | 0.393 |
| 752 7088               | FM2840MP        | STEEL     | -----             | 67              | INT TH  | 290.1 | x | 195.1 | x         | 2.5  | 11.42 | x | 7.68  | x | 0.098 |
| 752 7089               | FM1601          | BRONZE    | -----             | 95              | EXT TH  | 305.6 | x | 212.6 | x         | 4.7  | 12.03 | x | 8.37  | x | 0.187 |
| <b>BENFORD</b>         |                 |           |                   |                 |         |       |   |       |           |      |       |   |       |   |       |
| 800-4025               | FM3001          | BRONZE    | SPR/WAG           | 15              | INT TH  | 152.0 | x | 30.1  | x         | 4.8  | 5.98  | x | 1.18  | x | 0.189 |
| 800-4026               | FM3900MP        | STEEL     | -----             | 2               | EXT SL  | 167.0 | x | 122.0 | x         | 2.5  | 6.57  | x | 4.8   | x | 0.098 |
| 800-2048               | FM4014MP        | STEEL     | -----             | 3               | EXT SL  | 202.0 | x | 140.0 | x         | 2.5  | 7.95  | x | 5.51  | x | 0.098 |
| 800-2049               | FM3002          | BRONZE    | SPR/WAG           | 15              | INT TH  | 178.0 | x | 36.0  | x         | 4.8  | 7     | x | 1.42  | x | 0.189 |
| 800-2131               | FM3000          | BRONZE    | SPR/WAG           | 15              | INT TH  | 224.0 | x | 42.8  | x         | 4.8  | 8.82  | x | 1.69  | x | 0.189 |
| 800-9092               | FM2829          | PAPER     | 2 PASS            | 45              | INT TH  | 133.1 | x | 92.7  | x         | 2.1  | 5.24  | x | 3.65  | x | 0.083 |
| 800-9093               | FM1324MP        | STEEL     | -----             | 54              | EXT TH  | 139.2 | x | 98.6  | x         | 1.8  | 5.48  | x | 3.88  | x | 0.07  |
| <b>BENFRA</b>          |                 |           |                   |                 |         |       |   |       |           |      |       |   |       |   |       |
| 1420482M1              | FM4336MP        | STEEL     | -----             | 28              | INT TH  | 127.0 | x | 79.0  | x         | 1.8  | 5.0   | x | 3.11  | x | 0.071 |
| 51317                  | FM2865          | BRONZE    | SUNBURST          | 64              | EXT TH  | 138.8 | x | 95.2  | x         | 2.8  | 5.46  | x | 3.75  | x | 0.11  |
| 52581                  | FM7682MP        | STEEL     | -----             | 22              | INT TH  | 102.0 | x | 60.7  | x         | 1.5  | 4.02  | x | 2.39  | x | 0.059 |
| <b>BOMAG</b>           |                 |           |                   |                 |         |       |   |       |           |      |       |   |       |   |       |
| 5815571                | FM4405          | BRONZE    | SPIRAL            | 22              | INT TH  | 188.0 | x | 110.0 | x         | 2.3  | 7.4   | x | 4.33  | x | 0.089 |
| 5815580                | FM5838MP        | STEEL     | -----             | 38              | EXT TH  | 198.6 | x | 152.0 | x         | 1.5  | 7.82  | x | 5.98  | x | 0.059 |
| 5815727                | FM6695          | BRONZE    | WAFFLE            | 51              | EXT TH  | 103.7 | x | 77.1  | x         | 1.9  | 4.08  | x | 3.04  | x | 0.075 |
| 5815728                | FM6698MP        | STEEL     | -----             | 36              | INT TH  | 97.5  | x | 71.2  | x         | 1.0  | 3.84  | x | 2.8   | x | 0.039 |
| 32010075               | FM4606MP        | STEEL     | -----             | 3               | EXT LG  | 216.9 | x | 144.0 | x         | 2.7  | 8.54  | x | 5.67  | x | 0.106 |
| 32010076               | FM4625          | PAPER     | SUNBURST          | 16              | INT TH  | 201.0 | x | 40.5  | x         | 4.9  | 7.91  | x | 1.59  | x | 0.192 |
| H1000000143            | FM2277          | BRONZE    | SUNBURST          | 27              | EXT TH  | 137.4 | x | 90.9  | x         | 2.0  | 5.41  | x | 3.58  | x | 0.079 |
| H1000000151            | FM4123          | BRONZE    | SUN-PLAIN         | 27              | EXT TH  | 137.4 | x | 90.9  | x         | 1.6  | 5.41  | x | 3.58  | x | 0.063 |
| H1000002086            | FM3592MP        | STEEL     | -----             | 29              | INT TH  | 131.1 | x | 85.1  | x         | 1.5  | 5.16  | x | 3.35  | x | 0.059 |
| H1000002087            | FM3596MP        | STEEL     | -----             | 29              | INT TH  | 131.1 | x | 85.1  | x         | 2.5  | 5.16  | x | 3.35  | x | 0.098 |
| H1000002088            | FM3594MP        | STEEL     | -----             | 29              | INT TH  | 131.1 | x | 85.1  | x         | 2.0  | 5.16  | x | 3.35  | x | 0.079 |
| H1000002201            | FM3604MP        | STEEL     | -----             | 35              | INT TH  | 170.9 | x | 102.9 | x         | 2.5  | 6.73  | x | 4.05  | x | 0.098 |
| H1000002629            | FM4089          | PAPER     | 3 PASS            | 48              | INT TH  | 232.7 | x | 142.0 | x         | 4.0  | 9.16  | x | 5.59  | x | 0.157 |
| H1000002843            | FM4686MP        | STEEL     | -----             | 81              | EXT TH  | 243.6 | x | 152.1 | x         | 2.5  | 9.59  | x | 5.99  | x | 0.098 |

| REPLACES<br>OEM PT.NO. | FMC<br>PART NO. | MATERIAL             | GROOVE<br>DETAILS | TEETH/<br>TANGS | SIZE MM   |       |   |       | SIZE INCH |     |      |   |      |   |       |
|------------------------|-----------------|----------------------|-------------------|-----------------|-----------|-------|---|-------|-----------|-----|------|---|------|---|-------|
| <b>BRAY</b>            |                 |                      |                   |                 |           |       |   |       |           |     |      |   |      |   |       |
| C35433A                | FM1389          | BRONZE               | SPIRAL            | 57              | INT TH    | 128.3 | x | 87.9  | x         | 2.5 | 5.05 | x | 3.46 | x | 0.098 |
| P11294/22              | FM1591          | BRONZE               | SPR/WAG           | 22              | INT TH    | 224.0 | x | 53.3  | x         | 4.8 | 8.82 | x | 2.1  | x | 0.19  |
| P11294/23              | FM1190MP        | STEEL                | -----             | 1               | EXT LG    | 228.6 | x | 127.0 | x         | 2.6 | 9.0  | x | 5    | x | 0.102 |
| P15108/104             | FM1801          | BRONZE               | WAFFLE            | 76              | EXT TH    | 164.1 | x | 103.1 | x         | 2.8 | 6.46 | x | 4.06 | x | 0.11  |
| P15306/81              | FM1705          | BRONZE               | SPR/WAG           | 22              | INT TH    | 204.5 | x | 53.3  | x         | 4.8 | 8.05 | x | 2.1  | x | 0.19  |
|                        |                 |                      |                   |                 |           |       |   |       |           |     |      |   |      |   |       |
| P15306/82              | FM1202MP        | STEEL                | -----             | 1               | EXT LG    | 209.3 | x | 114.3 | x         | 2.7 | 8.24 | x | 4.5  | x | 0.106 |
| P20060/136             | FM1801          | BRONZE               | WAFFLE            | 76              | EXT TH    | 164.1 | x | 103.1 | x         | 2.8 | 6.46 | x | 4.06 | x | 0.11  |
| <b>BREVINI</b>         |                 |                      |                   |                 |           |       |   |       |           |     |      |   |      |   |       |
| 235.000.0414           | FM9522MP        | STEEL                | -----             | 6               | EXT LG    | 156.7 | x | 103.2 | x         | 1.7 | 6.17 | x | 4.06 | x | 0.067 |
| 235.000.0415           | FM9519          | BRONZE               | SUNBURST          | 38              | INT TH    | 140.7 | x | 100.4 | x         | 2.5 | 5.54 | x | 3.95 | x | 0.098 |
| 386 3083 000           | FM4308MP        | STEEL                | -----             | 6               | EXT LG    | 266.7 | x | 192.4 | x         | 3.0 | 10.5 | x | 7.57 | x | 0.118 |
| 386 3073 000           | FM4305          | BRONZE               | SPR/WAG           | 36              | INT TH    | 249.7 | x | 177.5 | x         | 3.5 | 9.83 | x | 6.99 | x | 0.138 |
| 389 1050 000           | FM3419          | BRONZE               | WAFFLE            | 32              | INT TH    | 90.0  | x | 64.3  | x         | 1.6 | 3.54 | x | 2.53 | x | 0.063 |
|                        |                 |                      |                   |                 |           |       |   |       |           |     |      |   |      |   |       |
| 389 1070 000           | FM6038MP        | STEEL                | -----             | 36              | EXT TH    | 93.3  | x | 71.8  | x         | 3.0 | 3.67 | x | 2.83 | x | 0.118 |
| 44100200002            | FM4314MP        | STEEL                | -----             | 28              | INT TH    | 127.0 | x | 79.0  | x         | 1.5 | 5.0  | x | 3.11 | x | 0.059 |
| 44104600005            | FM2865          | BRONZE               | SUNBURST          | 64              | EXT TH    | 138.8 | x | 95.2  | x         | 2.8 | 5.46 | x | 3.75 | x | 0.11  |
| ?                      | FM4309OE        | BRONZE               | SUN/WAG           | 50              | EXT TH    | 152.6 | x | 109.0 | x         | 3.0 | 6    | x | 4.29 | x | 0.118 |
| ?                      | FM4312MP        | STEEL                | -----             | 38              | INT TH    | 141.0 | x | 90.0  | x         | 1.8 | 5.55 | x | 3.54 | x | 0.071 |
|                        |                 |                      |                   |                 |           |       |   |       |           |     |      |   |      |   |       |
| ?                      | FM4912MP        | STEEL                | -----             | 36              | EXT TH    | 93.3  | x | 71.8  | x         | 1.0 | 3.67 | x | 2.8  | x | 0.039 |
| <b>BROCKHOUSE</b>      |                 |                      |                   |                 |           |       |   |       |           |     |      |   |      |   |       |
| F14915/3               | FM1302MP        | STEEL                | -----             | 64              | EXT TH    | 137.2 | x | 96.3  | x         | 1.5 | 5.4  | x | 3.79 | x | 0.059 |
| F34413                 | FM0541          | BRONZE               | SUNBURST          | 38              | INT TH    | 162.6 | x | 120.9 | x         | 2.3 | 6.4  | x | 4.76 | x | 0.09  |
| G15640                 | FM1544MP        | STEEL                | -----             | 33              | EXT TH    | 144.0 | x | 94.5  | x         | 1.4 | 5.67 | x | 3.72 | x | 0.055 |
| G15685                 | FM1288MP        | STEEL                | -----             | 79              | EXT TH    | 168.7 | x | 104.1 | x         | 1.5 | 6.64 | x | 4.1  | x | 0.059 |
| G15686                 | FM0177          | BRONZE               | SUNBURST          | 38              | INT TH    | 163.3 | x | 92.7  | x         | 2.4 | 6.43 | x | 3.65 | x | 0.095 |
|                        |                 |                      |                   |                 |           |       |   |       |           |     |      |   |      |   |       |
| G16540                 | FM1389          | BRONZE               | SPIRAL            | 57              | INT TH    | 128.3 | x | 87.9  | x         | 2.5 | 5.05 | x | 3.46 | x | 0.098 |
| G19130                 | FM1304MP        | STEEL                | -----             | 40              | (52)EX TH | 170.9 | x | 130.3 | x         | 1.4 | 6.73 | x | 5.13 | x | 0.055 |
| G19131                 | FM0541          | BRONZE               | SUNBURST          | 38              | INT TH    | 162.6 | x | 120.9 | x         | 2.3 | 6.4  | x | 4.76 | x | 0.09  |
| G33246M                | FM0855          | OBSOLETE AFTER STOCK |                   | 38              | INT TH    | 162.6 | x | 120.9 | x         | 2.3 | 6.4  | x | 4.76 | x | 0.09  |
| G33249                 | FM1389          | BRONZE               | SPIRAL            | 57              | INT TH    | 128.3 | x | 87.9  | x         | 2.5 | 5.05 | x | 3.46 | x | 0.098 |
|                        |                 |                      |                   |                 |           |       |   |       |           |     |      |   |      |   |       |
| G33536                 | FM0177          | BRONZE               | SUNBURST          | 38              | INT TH    | 163.3 | x | 92.7  | x         | 2.5 | 6.43 | x | 3.65 | x | 0.098 |
| L500032                | FM0851          | OBSOLETE             | SUNBURST          | 51              | EXT TH    | 165.1 | x | 127.0 | x         | 2.4 | 6.5  | x | 5.0  | x | 0.095 |
| <b>BRODERSON</b>       |                 |                      |                   |                 |           |       |   |       |           |     |      |   |      |   |       |
| 910700148              | FM1935          | BRONZE               | 240 RADIAL        | 45              | INT TH    | 133.1 | x | 92.7  | x         | 1.6 | 5.24 | x | 3.65 | x | 0.063 |
| 910700149              | FM1324MP        | STEEL                | -----             | 54              | EXT TH    | 139.2 | x | 98.6  | x         | 1.8 | 5.48 | x | 3.88 | x | 0.07  |
| 910700150              | FM5452MP        | STEEL                | END PLATE         | 54              | EXT TH    | 139.2 | x | 98.2  | x         | 8.7 | 5.48 | x | 3.87 | x | 0.343 |
| 910700163              | FM1933          | BRONZE               | RADIAL            | 59              | INT TH    | 190.8 | x | 147.3 | x         | 3.0 | 7.51 | x | 5.8  | x | 0.118 |
| 910700164              | FM1938MP        | STEEL                | -----             | 3               | EXT LG    | 214.9 | x | 155.7 | x         | 1.8 | 8.46 | x | 6.13 | x | 0.07  |
|                        |                 |                      |                   |                 |           |       |   |       |           |     |      |   |      |   |       |
| 910700293              | FM2829          | PAPER                | 2 PASS            | 45              | INT TH    | 133.1 | x | 92.7  | x         | 2.1 | 5.24 | x | 3.65 | x | 0.083 |
| 910700294              | FM3650MP        | STEEL                | -----             | 54              | EXT TH    | 139.2 | x | 98.6  | x         | 3.0 | 5.48 | x | 3.88 | x | 0.118 |

| REPLACES<br>OEM PT.NO. | FMC<br>PART NO. | MATERIAL             | GROOVE<br>DETAILS | TEETH/<br>TANGS | SIZE MM   | SIZE INCH                                 |
|------------------------|-----------------|----------------------|-------------------|-----------------|-----------|---|
| <b>CARCO WINCHES</b>   |                 |                      |                   |                 |           |   |
| 30382                  | FM3072MP        | STEEL                | -----             | 77              | INT TH    | 241.3 x 158.8 x 1.6 9.5 x 6.25 x 0.063    |
| 30383                  | FM1607          | BRONZE               | -----             | 119             | EXT TH    | 254.0 x 171.5 x 4.7 10.0 x 6.75 x 0.187   |
| 30661-3                | FM1601          | BRONZE               | -----             | 95              | EXT TH    | 305.6 x 212.6 x 4.7 12.03 x 8.37 x 0.187  |
| 30661-4                | FM1882MP        | STEEL                | -----             | 63              | INT TH    | 289.1 x 193.8 x 2.3 11.38 x 7.63 x 0.09   |
| 46129                  | FM1601          | BRONZE               | -----             | 95              | EXT TH    | 305.6 x 212.6 x 4.7 12.03 x 8.37 x 0.187  |
| 46131                  | FM2427          | OBSOLETE             | SUNBURST          | 77              | INT TH    | 241.0 x 159.3 x 4.7 9.49 x 6.27 x 0.185   |
| 46132                  | FM2430MP        | STEEL                | -----             | 119             | EXT TH    | 255.0 x 171.5 x 2.6 10.04 x 6.75 x 0.104  |
| 46142                  | FM1607          | BRONZE               | -----             | 119             | EXT TH    | 254.0 x 171.5 x 4.7 10.0 x 6.75 x 0.187   |
| 46143                  | FM3072MP        | STEEL                | -----             | 77              | INT TH    | 241.3 x 158.8 x 1.6 9.5 x 6.25 x 0.063    |
| F-29754                | FM3072MP        | STEEL                | -----             | 77              | INT TH    | 241.3 x 158.8 x 1.6 9.5 x 6.25 x 0.063    |
| <b>CARRARO</b>         |                 |                      |                   |                 |           |   |
| 7423                   | FM2969          | BRONZE               | WAFFLE            | 22              | INT TH    | 71.7 x 44.0 x 1.6 2.82 x 1.73 x 0.063     |
| 65604                  | FM2969KIT       |                      |                   |                 |           |   |
| 110642                 | FM2971          | BRONZE               | WAFFLE            | 22              | INT TH    | 71.7 x 44.0 x 2.8 2.82 x 1.73 x 0.11      |
| 110643                 | FM3474MP        | STEEL                | -----             | 4               | EXT LG    | 85.0 x 49.2 x 1.5 3.35 x 1.94 x 0.059     |
| 110644                 | FM2969          | BRONZE               | WAFFLE            | 22              | INT TH    | 71.7 x 44.0 x 1.6 2.82 x 1.73 x 0.063     |
| 112398                 | FM3841          | PAPER                | 2 PASS            | 23              | INT TH    | 178.0 x 44.0 x 4.8 7.01 x 1.73 x 0.189    |
| 117166                 | FM3289          | GRAPHITE             | SUNBURST          | 22              | INT TH    | 165.0 x 41.0 x 4.8 6.5 x 1.61 x 0.189     |
| 117167                 | FM3356MP        | STEEL                | -----             | 1               | EXT LG    | 172.0 x 94.0 x 2.7 6.77 x 3.7 x 0.104     |
| 119363                 | FM4015          | GRAPHITE             | SUNBURST          | 27              | INT TH    | 303.8 x 66.1 x 10.0 11.96 x 2.6 x 0.393   |
| 119682                 | FM2777          | GRAPHITE             | SUNBURST          | 27              | INT TH    | 260.0 x 66.1 x 10.0 10.24 x 2.6 x 0.394   |
| 120361                 | FM3474MP        | STEEL                | -----             | 4               | EXT LG    | 85.0 x 49.2 x 1.5 3.35 x 1.94 x 0.059     |
| 121254                 | FM5797          | GRAPHITE             | SUNBURST          | 27              | INT TH    | 255.0 x 66.1 x 10.0 10.04 x 2.6 x 0.394   |
| 121656                 | FM2781          | GRAPHITE             | SUNBURST          | 15              | INT TH    | 213.0 x 44.0 x 10.0 8.38 x 1.73 x 0.394   |
| 121656                 | FM2781CP        | CARBON PA            | SUNBURST          | 15              | INT TH    | 213.0 x 44.0 x 10.0 8.38 x 1.73 x 0.394   |
| 126072                 | FM9485          | GRAPHITE             | SUNBURST          | 12              | INT TH    | 170.0 x 32.7 x 4.8 6.69 x 1.29 x 0.189    |
| 130402                 | FM3103          | GRAPHITE             | WAFFLE            | 28              | INT TH    | 169.0 x 56.0 x 4.8 6.65 x 2.21 x 0.189    |
| 130403                 | FM3824MP        | STEEL                | -----             | 2               | EXT LG    | 195.0 x 110.0 x 2.6 7.68 x 4.33 x 0.102   |
| 132690                 | FM3351          | GRAPHITE             | SUNBURST          | 36              | INT TH    | 272.0 x 71.1 x 4.9 10.71 x 2.8 x 0.193    |
| 133924                 | FM2828MP        | STEEL                | -----             | 6               | EXT LG    | 151.0 x 98.0 x 2.5 5.94 x 3.86 x 0.098    |
| 133952                 | FM4815          | GRAPHITE             | SUNBURST          | 36              | (73)EX TH | 151.5 x 101.5 x 3.5 5.96 x 4.0 x 0.138    |
| 133953                 | FM4817          | GRAPH/STL            | SUN/PLAIN         | 36              | (73)EX TH | 151.5 x 101.5 x 2.8 5.96 x 4.0 x 0.108    |
| 133972                 | FM2825          | BRONZE               | SUNBURST          | 45              | INT TH    | 133.0 x 93.0 x 1.8 5.24 x 3.66 x 0.069    |
| 134181                 | FM3095          | GRAPHITE             | SUNBURST          | 13              | INT TH    | 215.0 x 36.5 x 10.0 8.46 x 1.44 x 0.394   |
| 134468                 | FM7065          | OBSOLETE AFTER STOCK |                   | 3               | EXT LG    | 220.0 x 139.0 x 4.2 8.66 x 5.47 x 0.165   |
| 134740                 | FM3910MP        | END PLATE            | -----             | 64              | EXT TH    | 230.0 x 151.0 x 9.0 9.06 x 5.94 x 0.354   |
| 136112                 | FM2823          | PAPER                | 2 PASS            | 36              | INT TH    | 223.0 x 71.0 x 4.9 8.78 x 2.8 x 0.191     |
| ALTERNATIVE            | FM6689          | PAPER                | 2 PASS            | 36              | INT TH    | 223.0 x 71.0 x 4.9 8.78 x 2.8 x 0.191     |
| 136132                 | FM2823          | PAPER                | 2 PASS            | 36              | INT TH    | 223.0 x 71.0 x 4.9 8.78 x 2.8 x 0.191     |
| 136136                 | FM5380MP        | STEEL                | -----             | 32              | (80)EX TH | 281.8 x 207.7 x 11.3 11.09 x 8.18 x 0.443 |
| 136137                 | FM5382MP        | STEEL                | -----             | 32              | (80)EX TH | 281.8 x 207.7 x 9.0 11.09 x 8.18 x 0.354  |
| 136138                 | FM5384MP        | STEEL                | -----             | 32              | (80)EX TH | 281.8 x 207.7 x 9.0 11.09 x 8.18 x 0.354  |
| 136139                 | FM5420MP        | STEEL                | -----             | 32              | (80)EX TH | 282.0 x 207.5 x 5.0 11.1 x 8.17 x 0.197   |
| 136155                 | FM3912MP        | END PLATE            | -----             | 64              | EXT TH    | 230.0 x 152.5 x 5.0 9.06 x 6.0 x 0.197    |
| 136644                 | FM3414MP        | END PLATE            | -----             | 32              | (64)EX TH | 230.0 x 152.5 x 10.8 9.06 x 6.0 x 0.397   |
| 136645                 | FM3906MP        | END PLATE            | -----             | 32              | (64)EX TH | 230.0 x 152.5 x 9.0 9.06 x 6.0 x 0.354    |

| REPLACES<br>OEM PT.NO.    | FMC<br>PART NO. | MATERIAL             | GROOVE<br>DETAILS | TEETH/<br>TANGS | SIZE MM   |       |   | SIZE INCH |   |      |       |   |       |   |       |
|---------------------------|-----------------|----------------------|-------------------|-----------------|-----------|-------|---|-----------|---|------|-------|---|-------|---|-------|
| 136646                    | FM3908MP        | END PLATE            | -----             | 32              | (64)EX TH | 230.0 | x | 152.5     | x | 9.0  | 9.06  | x | 6.0   | x | 0.354 |
| 137740                    | FM3910MP        | END PLATE            | -----             | 64              | EXT TH    | 230.0 | x | 151.0     | x | 9.0  | 9.06  | x | 5.94  | x | 0.354 |
| 138377                    | FM3020MP        | STEEL                | -----             | 8               | EXT LG    | 210.8 | x | 152.4     | x | 2.1  | 8.3   | x | 6.0   | x | 0.083 |
| 138378                    | FM3667          | PAPER                | 2 PASS            | 44              | INT TH    | 196.9 | x | 138.0     | x | 2.8  | 7.75  | x | 5.43  | x | 0.11  |
| 138574                    | FM2825          | BRONZE               | SUNBURST          | 45              | INT TH    | 133.0 | x | 93.0      | x | 1.8  | 5.24  | x | 3.66  | x | 0.069 |
| 141592                    | FM9421          | PAPER                | WAFFLE            | 55              | INT TH    | 260.0 | x | 164.2     | x | 4.0  | 10.24 | x | 6.46  | x | 0.157 |
| 142307                    | FM6720MP        | STEEL                | -----             | 3               | EXT LG    | 302.6 | x | 178.2     | x | 6.0  | 11.91 | x | 7.02  | x | 0.236 |
| 143847                    | FM5201          | PAPER                | WAFFLE            | 22              | INT TH    | 165.0 | x | 41.0      | x | 4.7  | 6.5   | x | 1.61  | x | 0.185 |
| 143874                    | FM7337          | PAPER                | 2 PASS            | 36              | INT TH    | 223.0 | x | 71.0      | x | 4.9  | 8.78  | x | 2.8   | x | 0.191 |
| 145139                    | FM5271          | OBSOLETE AFTER STOCK |                   | 12              | INT TH    | 274.0 | x | 45.0      | x | 6.8  | 10.79 | x | 1.77  | x | 0.268 |
| 146951                    | FM3414MP        | END PLATE            | -----             | 32              | (64)EX TH | 230.0 | x | 152.5     | x | 10.8 | 9.06  | x | 6.0   | x | 0.397 |
| 148487                    | FM6590MP        | STEEL                | -----             | 3               | EXT SL    | 335.5 | x | 188.4     | x | 5.0  | 13.21 | x | 7.42  | x | 0.197 |
| 148488                    | FM6592MP        | STEEL                | -----             | 3               | EXT SL    | 335.5 | x | 188.4     | x | 8.0  | 13.21 | x | 7.42  | x | 0.315 |
| 148795                    | FM6587          | PAPER                | WAFFLE            | 15              | INT TH    | 289.0 | x | 43.0      | x | 6.7  | 11.38 | x | 1.69  | x | 0.262 |
| 149708                    | FM6717          | PAPER                | WAFFLE            | 29              | INT TH    | 259.0 | x | 85.0      | x | 4.0  | 10.2  | x | 3.35  | x | 0.157 |
| 382114                    | FM7337          | PAPER                | 2 PASS            | 36              | INT TH    | 223.0 | x | 71.0      | x | 4.9  | 8.78  | x | 2.8   | x | 0.191 |
| 502791                    | FM7067          | CARBON               | SUN/RAD           | 22              | INT TH    | 204.5 | x | 53.5      | x | 4.9  | 8.05  | x | 2.11  | x | 0.191 |
| 831428                    | FM8263          | BRONZE               | WAF/RAD           | 54              | EXT TH    | 109.4 | x | 82.1      | x | 1.6  | 4.31  | x | 3.23  | x | 0.063 |
| 831815                    | FM4347          | BRONZE               | WAFFLE            | 65              | (75)EX TH | 190.5 | x | 132.0     | x | 1.8  | 7.5   | x | 5.2   | x | 0.071 |
| 831816                    | FM8820MP        | STEEL                | HARDENED          | 31              | INT TH    | 168.6 | x | 122.3     | x | 2.0  | 6.64  | x | 4.81  | x | 0.079 |
| 831946                    | FM6926MP        | STEEL                | HARDENED          | 48              | EXT TH    | 99.5  | x | 77.2      | x | 1.1  | 3.92  | x | 3.04  | x | 0.043 |
| 831947                    | FM6923          | BRONZE               | WAFFLE            | 37              | INT TH    | 93.8  | x | 72.5      | x | 2.3  | 3.69  | x | 2.85  | x | 0.091 |
| 831976                    | FM6930MP        | STEEL                | HARDENED          | 45              | INT TH    | 123.9 | x | 89.2      | x | 2.0  | 4.88  | x | 3.51  | x | 0.079 |
| 831978                    | FM9056MP        | STEEL                | HARDENED          | 33              | (39)IN TH | 234.8 | x | 154.0     | x | 2.7  | 9.24  | x | 6.6   | x | 0.106 |
| 831995                    | FM8263          | BRONZE               | WAF/RAD           | 54              | EXT TH    | 109.4 | x | 82.1      | x | 1.6  | 4.31  | x | 3.23  | x | 0.063 |
| 831996                    | FM8816MP        | STEEL                | HARDENED          | 52              | INT TH    | 102.0 | x | 77.2      | x | 1.5  | 4.02  | x | 3.04  | x | 0.059 |
| 831999                    | FM9053          | BRONZE               | SUN/WAF           | 42              | (48)EX TH | 248.5 | x | 164.7     | x | 2.6  | 9.78  | x | 6.48  | x | 0.102 |
| 832785                    | FM6927          | BRONZE               | WAFFLE            | 64              | EXT TH    | 129.5 | x | 96.1      | x | 1.7  | 5.1   | x | 3.78  | x | 0.065 |
| 834578                    | FM8978MP        | STEEL                | -----             | 6               | EXT LG    | 265.8 | x | 147.0     | x | 4.0  | 10.46 | x | 5.79  | x | 0.157 |
| 834581                    | FM8975          | CARBON PA            | 4 PASS            | 32              | INT TH    | 236.0 | x | 94.1      | x | 5.5  | 9.29  | x | 3.7   | x | 0.217 |
| 866225                    | FM7617          | PAPER                | WAFFLE            | 14              | INT TH    | 245.6 | x | 58.3      | x | 4.5  | 9.67  | x | 2.3   | x | 0.177 |
| ?                         | FM9283          | GRAPHITE             | SUNBURST          | 23              | INT TH    | 143.0 | x | 44.0      | x | 4.9  | 5.63  | x | 1.73  | x | 0.191 |
| <b>CASE (DAVID BROWN)</b> |                 |                      |                   |                 |           |       |   |           |   |      |       |   |       |   |       |
| A14509                    | FM3382FP        | STEEL                | FLEXI PLATE       | 6               | HOLE      | 339.7 | x | 133.4     | x | 1.5  | 13.37 | x | 5.25  | x | 0.059 |
| A14510                    | FM4442FP        | STEEL                | REINF PLATE       | 6               | HOLE      | 186.5 | x | 132.0     | x | 2.1  | 7.34  | x | 5.2   | x | 0.83  |
| A17919                    | FM7462MP        | END PLATE            | -----             | 60              | EXT TH    | 154.3 | x | 113.5     | x | 8.0  | 6.07  | x | 4.47  | x | 0.315 |
| A17920                    | FM1305OE        | BRONZE               | RADIAL            | 52              | INT TH    | 148.6 | x | 107.7     | x | 2.6  | 5.85  | x | 4.24  | x | 0.102 |
| A17921                    | FM1216MP        | STEEL                | -----             | 60              | EXT TH    | 154.2 | x | 113.8     | x | 1.8  | 6.07  | x | 4.48  | x | 0.07  |
| A41005                    | FM1262MP        | STEEL                | -----             | 8               | EXT LG    | 142.5 | x | 99.1      | x | 1.6  | 5.61  | x | 3.9   | x | 0.063 |
| A41355                    | FM1359          | BRONZE               | SPIRAL            | 45              | INT TH    | 133.1 | x | 92.7      | x | 1.6  | 5.24  | x | 3.65  | x | 0.063 |
| A52252                    | FM2844MP        | STEEL                | -----             | 1               | EXT SL    | 209.2 | x | 120.0     | x | 3.0  | 8.23  | x | 4.72  | x | 0.118 |
| A52253                    | FM2841          | BRONZE               | SPR/RAD           | 19              | INT TH    | 203.2 | x | 57.2      | x | 4.7  | 8.0   | x | 2.25  | x | 0.185 |
| A64525                    | FM3261          | PAPER                | 2 PASS            | 40              | INT TH    | 127.1 | x | 82.2      | x | 2.5  | 5.0   | x | 3.24  | x | 0.98  |
| A99132                    | FM1245          | BRONZE               | SUNBURST          | 73              | INT TH    | 371.3 | x | 303.0     | x | 5.2  | 14.62 | x | 11.93 | x | 0.205 |
| A133720                   | FM2985          | PAPER                | 3 PASS            | 14              | INT TH    | 300.7 | x | 49.9      | x | 6.3  | 11.84 | x | 1.96  | x | 0.248 |
| A169583                   | FM8676MP        | STEEL                | -----             | 40              | INT TH    | 127.0 | x | 82.0      | x | 2.2  | 5.0   | x | 3.23  | x | 0.087 |
| A175072                   | FM3261          | PAPER                | 2 PASS            | 40              | INT TH    | 127.1 | x | 82.2      | x | 2.5  | 5.0   | x | 3.24  | x | 0.98  |

| REPLACES<br>OEM PT.NO. | FMC<br>PART NO. | MATERIAL  | GROOVE<br>DETAILS | TEETH/<br>TANGS | SIZE MM   | SIZE INCH            |                       |
|------------------------|-----------------|-----------|-------------------|-----------------|-----------|----------------------|-----------------------|
| A175806                | FM3264MP        | STEEL     | -----             | 26              | EXT TH    | 143.5 x 89.5 x 2.2   | 5.65 x 3.52 x 0.084   |
| A178020                | FM3902MP        | END PLATE | -----             | 26              | EXT TH    | 143.4 x 89.5 x 10.9  | 5.65 x 3.52 x 0.429   |
| A188412                | FM2985          | PAPER     | 3 PASS            | 14              | INT TH    | 300.7 x 49.9 x 6.3   | 11.84 x 1.96 x 0.248  |
| A188853                | FM6563          | PAPER     | 2 PASS            | 34              | INT TH    | 136.0 x 68.2 x 2.1   | 5.35 x 2.69 x 0.081   |
| A188868                | FM8673          | CARBON PA | WAFFLE            | 26              | EXT TH    | 143.4 x 89.5 x 2.5   | 5.65 x 3.52 x 0.098   |
| A188869                | FM8676MP        | STEEL     | -----             | 40              | INT TH    | 127.0 x 82.0 x 2.2   | 5.0 x 3.23 x 0.087    |
| A188946                | FM3261          | PAPER     | 2 PASS            | 40              | INT TH    | 127.1 x 82.2 x 2.5   | 5.0 x 3.24 x 0.98     |
| A190067                | FM4243          | PAPER     | 3 PASS            | 16              | INT TH    | 301.0 x 54.0 x 6.3   | 11.85 x 2.13 x 0.248  |
| A458320                | FM3785          | BRONZE    | SPIRAL            | 32              | EXT TH    | 133.2 x 91.0 x 2.4   | 5.24 x 3.58 x 0.094   |
| D50040                 | FM1933          | BRONZE    | RADIAL            | 59              | INT TH    | 190.8 x 147.3 x 3.0  | 7.51 x 5.8 x 0.118    |
| D50041                 | FM1938MP        | STEEL     | -----             | 3               | EXT LG    | 214.9 x 155.7 x 1.8  | 8.46 x 6.13 x 0.07    |
| D50047                 | FM4222SP        | STEEL     | SPRING            | 8               | INT TH    | 134.7 x 73.6 x 1.8   | 5.3 x 2.9 x 0.071     |
| D50081                 | FM5442MP        | STEEL     | END PLATE         | 54              | EXT TH    | 139.2 x 98.2 x 8.3   | 5.48 x 3.87 x 0.327   |
| D50082                 | FM1359          | BRONZE    | SPIRAL            | 45              | INT TH    | 133.1 x 92.7 x 1.6   | 5.24 x 3.65 x 0.063   |
| D50083                 | FM1324MP        | STEEL     | -----             | 54              | EXT TH    | 139.2 x 98.6 x 1.8   | 5.48 x 3.88 x 0.07    |
| D50084                 | FM5452MP        | STEEL     | END PLATE         | 54              | EXT TH    | 139.2 x 98.2 x 8.7   | 5.48 x 3.87 x 0.343   |
| D55252                 | FM1305OE        | BRONZE    | RADIAL            | 52              | INT TH    | 148.6 x 107.7 x 2.6  | 5.85 x 4.24 x 0.102   |
| D56914                 | FM1497OF        | ORGANIC   | 16 HOLES          | 96              | INT TH    | 357.9 x 298.5 x 20.8 | 14.09 x 11.75 x 0.819 |
| D70672                 | FM2465          | PAPER     | 1 PASS            | 43              | (45)IN TH | 133.1 x 92.7 x 1.6   | 5.24 x 3.65 x 0.063   |
| D72327                 | FM1324MP        | STEEL     | -----             | 54              | EXT TH    | 139.2 x 98.6 x 1.8   | 5.48 x 3.88 x 0.07    |
| D72803                 | FM1216MP        | STEEL     | -----             | 60              | EXT TH    | 154.2 x 113.8 x 1.8  | 6.07 x 4.48 x 0.07    |
| D77063                 | FM1381OE        | BRONZE    | RADIAL            | 52              | INT TH    | 148.6 x 107.7 x 2.9  | 5.85 x 4.24 x 0.114   |
| D77576                 | FM1305OE        | BRONZE    | RADIAL            | 52              | INT TH    | 148.6 x 107.7 x 2.6  | 5.85 x 4.24 x 0.102   |
| D79944                 | FM1816MP        | STEEL     | DISHED            | 32              | (42)EX TH | 184.2 x 92.7 x 2.6   | 7.25 x 3.65 x 0.102   |
| D80064                 | FM0647          | BRONZE    | SUNBURST          | 19              | INT TH    | 165.1 x 74.2 x 4.0   | 6.5 x 2.92 x 0.156    |
| D81592                 | FM4442FP        | STEEL     | REINF PLATE       | 6               | HOLE      | 186.5 x 132.0 x 2.1  | 7.34 x 5.2 x 0.83     |
| D83009                 | FM1324MP        | STEEL     | -----             | 54              | EXT TH    | 139.2 x 98.6 x 1.8   | 5.48 x 3.88 x 0.07    |
| D87201                 | FM3382FP        | STEEL     | FLEXI PLATE       | 6               | HOLE      | 339.7 x 133.4 x 1.5  | 13.37 x 5.25 x 0.059  |
| D106118                | FM1307OE        | BRONZE    | RADIAL            | 52              | INT TH    | 148.6 x 107.7 x 2.6  | 5.85 x 4.24 x 0.102   |
| D131147                | FM7228FP        | STEEL     | -----             |                 | HOLES     | 339.8 x 133.3 x 1.5  | 13.38 x 5.25 x 0.059  |
| D3145322               | FM6698MP        | STEEL     | -----             | 36              | INT TH    | 97.5 x 71.2 x 1.0    | 3.84 x 2.8 x 0.039    |
| E68704                 | FM1359          | BRONZE    | SPIRAL            | 45              | INT TH    | 133.1 x 92.7 x 1.6   | 5.24 x 3.65 x 0.063   |
| E114383                | FM1324MP        | STEEL     | -----             | 54              | EXT TH    | 139.2 x 98.6 x 1.8   | 5.48 x 3.88 x 0.07    |
| E135004                | FM2277          | BRONZE    | SUNBURST          | 27              | EXT TH    | 137.4 x 90.9 x 2.0   | 5.41 x 3.58 x 0.079   |
| E135005                | FM2279          | BRONZE    | SUNBURST          | 35              | EXT TH    | 177.5 x 109 x 2.0    | 6.99 x 4.29 x 0.079   |
| E135224                | FM3592MP        | STEEL     | -----             | 29              | INT TH    | 131.1 x 85.1 x 1.5   | 5.16 x 3.35 x 0.059   |
| E135225                | FM3596MP        | STEEL     | -----             | 29              | INT TH    | 131.1 x 85.1 x 2.5   | 5.16 x 3.35 x 0.098   |
| E135226                | FM3594MP        | STEEL     | -----             | 29              | INT TH    | 131.1 x 85.1 x 2.0   | 5.16 x 3.35 x 0.079   |
| E135262                | FM3604MP        | STEEL     | -----             | 35              | INT TH    | 170.9 x 102.9 x 2.5  | 6.73 x 4.05 x 0.098   |
| E135271                | FM3602MP        | STEEL     | -----             | 35              | INT TH    | 170.9 x 102.9 x 2.0  | 6.73 x 4.05 x 0.079   |
| E135272                | FM3604MP        | STEEL     | -----             | 35              | INT TH    | 170.9 x 102.9 x 2.5  | 6.73 x 4.05 x 0.098   |
| E135797                | FM2777          | GRAPHITE  | SUNBURST          | 27              | INT TH    | 260.0 x 66.1 x 10.0  | 10.24 x 2.6 x 0.394   |
| E159987                | FM3650MP        | STEEL     | -----             | 54              | EXT TH    | 139.2 x 98.6 x 3.0   | 5.48 x 3.88 x 0.118   |
| E159992                | FM2829          | PAPER     | 2 PASS            | 45              | INT TH    | 133.1 x 92.7 x 2.1   | 5.24 x 3.65 x 0.083   |
| H14510                 | FM4442FP        | STEEL     | REINF PLATE       | 6               | HOLE      | 186.5 x 132.0 x 2.1  | 7.34 x 5.2 x 0.83     |
| J1043150               | FM6695          | BRONZE    | WAFFLE            | 51              | EXT TH    | 103.7 x 77.1 x 1.9   | 4.08 x 3.04 x 0.075   |
| K200550                | FM1284MP        | STEEL     | -----             | 1               | EXT LG    | 182.9 x 82.6 x 2.7   | 7.2 x 3.25 x 0.106    |

| REPLACES<br>OEM PT.NO. | FMC<br>PART NO. | MATERIAL   | GROOVE<br>DETAILS | TEETH/<br>TANGS | SIZE MM   |       |   | SIZE INCH |   |      |       |   |       |   |       |
|------------------------|-----------------|------------|-------------------|-----------------|-----------|-------|---|-----------|---|------|-------|---|-------|---|-------|
| K202905                | FM1769          | BRONZE     | SPR/WAG           | 26              | INT TH    | 178.1 | x | 63.5      | x | 4.8  | 7.01  | x | 2.5   | x | 0.19  |
| K206041                | FM3490A         | STEEL      | -----             | 50              | EXT TH    | 162.0 | x | 118.2     | x | 1.6  | 6.38  | x | 4.65  | x | 0.063 |
| K261860                | FM2971          | BRONZE     | WAFFLE            | 22              | INT TH    | 71.7  | x | 44.0      | x | 2.8  | 2.82  | x | 1.73  | x | 0.11  |
| K261862                | FM2969          | BRONZE     | WAFFLE            | 22              | INT TH    | 71.7  | x | 44.0      | x | 1.6  | 2.82  | x | 1.73  | x | 0.063 |
| K261863                | FM3474MP        | STEEL      | -----             | 4               | EXT LG    | 85.0  | x | 49.2      | x | 1.5  | 3.35  | x | 1.94  | x | 0.059 |
| K262537                | FM3101A         | BRONZE     | CLUTCH KIT        |                 |           |       |   |           |   |      |       |   |       |   |       |
| K262538                | FM3101B         | BRONZE     | CLUTCH KIT        |                 |           |       |   |           |   |      |       |   |       |   |       |
| K904795A               | FM3490A         | STEEL      | -----             | 50              | EXT TH    | 162.0 | x | 118.2     | x | 1.6  | 6.38  | x | 4.65  | x | 0.063 |
| K940578/9              | FM3490B         | STEEL      | -----             | 50              | EXT TH    | 162.0 | x | 118.2     | x | 5.0  | 6.38  | x | 4.65  | x | 0.197 |
| K940877                | FM3487          | BRONZE     | SPR/RAD           | 30              | INT TH    | 155.7 | x | 60.5      | x | 2.6  | 6.13  | x | 2.38  | x | 0.102 |
| K945754                | FM1711          | BRONZE     | SPR/WAG           | 23              | INT TH    | 224.0 | x | 70.1      | x | 4.9  | 8.82  | x | 2.76  | x | 0.193 |
| K945755                | FM1204MP        | STEEL      | -----             | 1               | EXT LG    | 228.6 | x | 127.0     | x | 2.7  | 9.0   | x | 5.0   | x | 0.106 |
| K963646                | FM1711          | BRONZE     | SPR/WAG           | 23              | INT TH    | 224.0 | x | 70.1      | x | 4.9  | 8.82  | x | 2.76  | x | 0.193 |
| K963647                | FM1204MP        | STEEL      | -----             | 1               | EXT LG    | 228.6 | x | 127.0     | x | 2.7  | 9.0   | x | 5.0   | x | 0.106 |
| N4587                  | FM2465          | PAPER      | 1 PASS            | 43              | (45)IN TH | 133.1 | x | 92.7      | x | 1.6  | 5.24  | x | 3.65  | x | 0.063 |
| N7022                  | FM1179          | GRAPHITE   | SUNBURST          | 60              | INT TH    | 253.7 | x | 187.5     | x | 3.9  | 9.99  | x | 7.38  | x | 0.153 |
| N7217                  | FM1359          | BRONZE     | SPIRAL            | 45              | INT TH    | 133.1 | x | 92.7      | x | 1.6  | 5.24  | x | 3.65  | x | 0.063 |
| N7219                  | FM1324MP        | STEEL      | -----             | 54              | EXT TH    | 139.2 | x | 98.6      | x | 1.8  | 5.48  | x | 3.88  | x | 0.07  |
| N8738                  | FM1337OE        | BRONZE     | RADIAL            | 45              | INT TH    | 133.1 | x | 92.7      | x | 2.3  | 5.24  | x | 3.65  | x | 0.09  |
| N8750                  | FM2467          | BRONZE     | SPR/RAD           |                 |           | 253.5 | x | 74.4      | x | 3.9  | 9.98  | x | 2.93  | x | 0.153 |
| S73416                 | FM1933          | BRONZE     | RADIAL            | 59              | INT TH    | 190.8 | x | 147.3     | x | 3.0  | 7.51  | x | 5.8   | x | 0.118 |
| S73417                 | FM1938MP        | STEEL      | -----             | 3               | EXT LG    | 214.9 | x | 155.7     | x | 1.8  | 8.46  | x | 6.13  | x | 0.07  |
| S73428                 | FM5452MP        | STEEL      | END PLATE         | 54              | EXT TH    | 139.2 | x | 98.2      | x | 8.7  | 5.48  | x | 3.87  | x | 0.343 |
| S73434                 | FM5442MP        | STEEL      | END PLATE         | 54              | EXT TH    | 139.2 | x | 98.2      | x | 8.3  | 5.48  | x | 3.87  | x | 0.327 |
| S73872                 | FM1655          | BRONZE     | SUNBURST          | 52              | INT TH    | 148.6 | x | 107.4     | x | 1.6  | 5.85  | x | 4.23  | x | 0.062 |
| S73873                 | FM1216MP        | STEEL      | -----             | 60              | EXT TH    | 154.2 | x | 113.8     | x | 1.8  | 6.07  | x | 4.48  | x | 0.07  |
| S94326                 | FM1305OE        | BRONZE     | RADIAL            | 52              | INT TH    | 148.6 | x | 107.7     | x | 2.6  | 5.85  | x | 4.24  | x | 0.102 |
| S301550                | FM4123          | BRONZE     | SUN-PLAIN         | 27              | EXT TH    | 137.4 | x | 90.9      | x | 1.6  | 5.41  | x | 3.58  | x | 0.063 |
| 66188C1                | FM3144MP        | STEEL      | -----             | 6               | EXT LG    | 139.7 | x | 98.6      | x | 1.6  | 5.5   | x | 3.88  | x | 0.062 |
| 81620C1                | FM8999          | MOLYBDENUM | -----             | 36              | INT TH    | 71.7  | x | 44.8      | x | 1.5  | 2.82  | x | 1.76  | x | 0.059 |
| 81736C1                | FM2277          | BRONZE     | SUNBURST          | 27              | EXT TH    | 137.4 | x | 90.9      | x | 2.0  | 5.41  | x | 3.58  | x | 0.079 |
| 92934C2                | FM7888MP        | STEEL      | -----             | 6               | EXT LG    | 158.0 | x | 107.2     | x | 1.2  | 6.22  | x | 4.22  | x | 0.047 |
| 92935C3                | FM7783          | PAPER      | 2 PASS            | 48              | INT TH    | 140.8 | x | 98.9      | x | 2.0  | 5.54  | x | 3.89  | x | 0.079 |
| 92935C4                | FM7783          | PAPER      | 2 PASS            | 48              | INT TH    | 140.8 | x | 98.9      | x | 2.0  | 5.54  | x | 3.89  | x | 0.079 |
| 92935C5                | FM7783          | PAPER      | 2 PASS            | 48              | INT TH    | 140.8 | x | 98.9      | x | 2.0  | 5.54  | x | 3.89  | x | 0.079 |
| 100049A1               | FM2896MP        | STEEL      | -----             | 142             | EXT TH    | 455.0 | x | 342.0     | x | 4.0  | 17.91 | x | 13.46 | x | 0.157 |
| 100050A1               | FM2893          | PAPER      | 3 PASS            | 104             | INT TH    | 437.9 | x | 325.1     | x | 5.3  | 17.24 | x | 12.8  | x | 0.209 |
| 103310A1               | FM1216MP        | STEEL      | -----             | 60              | EXT TH    | 154.2 | x | 113.8     | x | 1.8  | 6.07  | x | 4.48  | x | 0.07  |
| 103310A1               | FM4486MP        | STEEL      | HARDENED          | 60              | EXT TH    | 154.2 | x | 113.8     | x | 1.8  | 6.07  | x | 4.48  | x | 0.07  |
| 114622C1               | FM3807          | YELLOW     | 2 PASS            | 15              | INT TH    | 259.1 | x | 51.1      | x | 7.6  | 10.2  | x | 2.01  | x | 0.3   |
| 114622C1               | FM1765          | RED PAPER  | 2 PASS            | 15              | INT TH    | 259.1 | x | 51.1      | x | 7.6  | 10.2  | x | 2.01  | x | 0.3   |
| 119228A1               | FM7500MP        | END PLATE  | STEPPED           | 35              | EXT TH    | 177.3 | x | 109.4     | x | 10.9 | 6.98  | x | 4.3   | x | 0.429 |
| 119229A1               | FM7500MP        | END PLATE  | STEPPED           | 35              | EXT TH    | 177.3 | x | 109.4     | x | 10.9 | 6.98  | x | 4.3   | x | 0.429 |
| 119335A1               | FM4666-2.2      | STEEL      | HARDENED          | 6               | EXT SL    | 130.0 | x | 66.8      | x | 2.2  | 5.12  | x | 2.63  | x | 0.087 |
| 119336A1               | FM4451          | MOLYBDENUM | SPR/WAG           | 46              | (50)IN TH | 117.5 | x | 62.6      | x | 2.6  | 4.63  | x | 2.46  | x | 0.102 |
| 119430A1               | FM3608MP        | STEEL      | -----             | 88              | (91)EX TH | 293.0 | x | 185.0     | x | 4.5  | 11.54 | x | 7.28  | x | 0.177 |
| 119431A1               | FM3606MP        | STEEL      | -----             | 88              | (91)EX TH | 293.0 | x | 185.0     | x | 4.0  | 11.54 | x | 7.28  | x | 0.157 |
| 119433A1               | FM2811          | PAPER      | 4 PASS            | 34              | INT TH    | 277.0 | x | 167.0     | x | 4.5  | 10.91 | x | 6.57  | x | 0.177 |

| REPLACES<br>OEM PT.NO. | FMC<br>PART NO. | MATERIAL         | GROOVE<br>DETAILS | TEETH/<br>TANGS | SIZE MM   |       |   | SIZE INCH |   |      |       |   |       |   |       |
|------------------------|-----------------|------------------|-------------------|-----------------|-----------|-------|---|-----------|---|------|-------|---|-------|---|-------|
| 120486C1               | FM7396MP        | STEEL            | -----             | 5               | EXT LG    | 350.0 | x | 192.0     | x | 2.8  | 13.78 | x | 7.56  | x | 0.108 |
| 120488C1               | FM7393          | PAPER            | WAFFLE            | 18              | INT TH    | 305.0 | x | 108.0     | x | 4.9  | 12.0  | x | 4.25  | x | 0.193 |
| 120488C2               | FM7393          | PAPER            | WAFFLE            | 18              | INT TH    | 305.0 | x | 108.0     | x | 4.9  | 12.0  | x | 4.25  | x | 0.193 |
| 120679C1               | FM9165          | PAPER            | 2 PASS            | 36              | INT HT    | 305.0 | x | 187.9     | x | 5.1  | 12.0  | x | 7.4   | x | 0.2   |
| 123773A1               | FM3606MP        | STEEL            | -----             | 88              | (91)EX TH | 293.0 | x | 185.0     | x | 4.0  | 11.54 | x | 7.28  | x | 0.157 |
| 129658A1               | FM4397          | BRONZE           | SUNBURST          | 64              | EXT TH    | 196.0 | x | 142.0     | x | 2.5  | 7.72  | x | 5.59  | x | 0.096 |
| 129659A1               | FM4399          | BRNZ/PLN         | SUNBURST          | 64              | EXT TH    | 196.0 | x | 142.0     | x | 2.0  | 7.72  | x | 5.59  | x | 0.077 |
| 146055A1               | FM7231          | PAPER            | 2 PASS            | 14              | INT TH    | 338.0 | x | 66.4      | x | 4.6  | 13.31 | x | 2.61  | x | 0.181 |
| 146057A1               | FM7234MP        | STEEL            | -----             | 3               | EXT SL    | 376.0 | x | 260.0     | x | 4.5  | 14.8  | x | 10.24 | x | 0.177 |
| 148903A1               | FM5407          | MOLYBDENUM       | RADIAL            | 34              | INT TH    | 109.8 | x | 66.0      | x | 1.3  | 4.32  | x | 2.6   | x | 0.052 |
| 148905A1               | FM6922MP        | STEEL            | HARDENED          | 4               | EXT LG    | 122.6 | x | 72.2      | x | 1.8  | 4.83  | x | 2.84  | x | 0.071 |
| 148906A1               | FM5409          | MOLYBDENUM/STEEL | RADIAL            | 34              | INT TH    | 109.8 | x | 66.0      | x | 2.9  | 4.32  | x | 2.6   | x | 0.112 |
| 148962A1               | FM4625          | PAPER            | SUNBURST          | 16              | INT TH    | 201.0 | x | 40.5      | x | 4.9  | 7.91  | x | 1.59  | x | 0.192 |
| 148963A1               | FM2344MP        | STEEL            | -----             | 6               | EXT LG    | 220.0 | x | 145.5     | x | 2.7  | 8.66  | x | 5.73  | x | 0.105 |
| 177732A1               | FM4451          | MOLYBDENUM       | SPR/WAG           | 46              | (50)IN TH | 117.5 | x | 62.6      | x | 2.6  | 4.63  | x | 2.46  | x | 0.102 |
| 181158A1               | FM2825          | BRONZE           | SUNBURST          | 45              | INT TH    | 133.0 | x | 93.0      | x | 1.8  | 5.24  | x | 3.66  | x | 0.069 |
| 181159A1               | FM2828MP        | STEEL            | -----             | 6               | EXT LG    | 151.0 | x | 98.0      | x | 2.5  | 5.94  | x | 3.86  | x | 0.098 |
| 181162A1               | FM3904MP        | END PLATE        | -----             | 6               | EXT LG    | 146.0 | x | 97.0      | x | 10.2 | 5.75  | x | 3.82  | x | 0.402 |
| 190455A1               | FM3414MP        | END PLATE        | -----             | 32              | (64)EX TH | 230.0 | x | 152.5     | x | 10.8 | 9.06  | x | 6.0   | x | 0.397 |
| 190462A1               | FM2823          | PAPER            | 2 PASS            | 36              | INT TH    | 223.0 | x | 71.0      | x | 4.9  | 8.78  | x | 2.8   | x | 0.191 |
| 190474A1               | FM3906MP        | END PLATE        | -----             | 32              | (64)EX TH | 230.0 | x | 152.5     | x | 9.0  | 9.06  | x | 6.0   | x | 0.354 |
| 196073A1               | FM2823          | PAPER            | 2 PASS            | 36              | INT TH    | 223.0 | x | 71.0      | x | 4.9  | 8.78  | x | 2.8   | x | 0.191 |
| 196081A1               | FM5384MP        | STEEL            | -----             | 32              | (80)EX TH | 281.8 | x | 207.7     | x | 9.0  | 11.09 | x | 8.18  | x | 0.354 |
| 230549A1               | FM4666MP        | STEEL            | HARDENED          | 6               | EXT SL    | 130.0 | x | 66.8      | x | 2.3  | 5.12  | x | 2.63  | x | 0.091 |
| 230550A1               | FM4666-2.4      | STEEL            | HARDENED          | 6               | EXT SL    | 130.0 | x | 66.8      | x | 2.4  | 5.12  | x | 2.63  | x | 0.094 |
| 230551A1               | FM4666-2.5      | STEEL            | HARDENED          | 6               | EXT SL    | 130.0 | x | 66.8      | x | 2.5  | 5.12  | x | 2.63  | x | 0.098 |
| 237017A1               | FM3351          | GRAPHITE         | SUNBURST          | 36              | INT TH    | 272.0 | x | 71.1      | x | 4.9  | 10.71 | x | 2.8   | x | 0.193 |
| 237018A1               | FM5380MP        | STEEL            | -----             | 32              | (80)EX TH | 281.8 | x | 207.7     | x | 11.3 | 11.09 | x | 8.18  | x | 0.443 |
| 237019A1               | FM5382MP        | STEEL            | -----             | 32              | (80)EX TH | 281.8 | x | 207.7     | x | 9.0  | 11.09 | x | 8.18  | x | 0.354 |
| 237020A1               | FM5384MP        | STEEL            | -----             | 32              | (80)EX TH | 281.8 | x | 207.7     | x | 9.0  | 11.09 | x | 8.18  | x | 0.354 |
| 237021A1               | FM2823          | PAPER            | 2 PASS            | 36              | INT TH    | 223.0 | x | 71.0      | x | 4.9  | 8.78  | x | 2.8   | x | 0.191 |
| ALTERNATIVE            | FM7337          | PAPER            | 2 PASS            | 36              | INT TH    | 223.0 | x | 71.0      | x | 4.9  | 8.78  | x | 2.8   | x | 0.191 |
| 237022A1               | FM3414MP        | END PLATE        | -----             | 32              | (64)EX TH | 230.0 | x | 152.5     | x | 10.8 | 9.06  | x | 6.0   | x | 0.397 |
| 237023A1               | FM3906MP        | END PLATE        | -----             | 32              | (64)EX TH | 230.0 | x | 152.5     | x | 9.0  | 9.06  | x | 6.0   | x | 0.354 |
| 237024A1               | FM3908MP        | END PLATE        | -----             | 32              | (64)EX TH | 230.0 | x | 152.5     | x | 9.0  | 9.06  | x | 6.0   | x | 0.354 |
| 242154A1               | FM5250-3.0      | STEEL            | HARDENED          | 4               | EXT LG    | 189.8 | x | 92.1      | x | 3.0  | 7.47  | x | 3.63  | x | 0.118 |
| 242155A1               | FM5250-2.9      | STEEL            | HARDENED          | 4               | EXT LG    | 189.8 | x | 92.1      | x | 2.9  | 7.47  | x | 3.63  | x | 0.114 |
| 242156A1               | FM5250-3.1      | STEEL            | HARDENED          | 4               | EXT LG    | 189.8 | x | 92.1      | x | 3.1  | 7.47  | x | 3.63  | x | 0.122 |
| 242157A1               | FM5250-2.7      | STEEL            | HARDENED          | 4               | EXT LG    | 189.8 | x | 92.1      | x | 2.7  | 7.47  | x | 3.63  | x | 0.106 |
| 242158A1               | FM5250-3.3      | STEEL            | HARDENED          | 4               | EXT LG    | 189.8 | x | 92.1      | x | 3.3  | 7.47  | x | 3.63  | x | 0.13  |
| 242159A1               | FM5247          | MOLYBDENUM       | SPR/WAG           | 40              | INT TH    | 172.0 | x | 84.1      | x | 3.0  | 6.77  | x | 3.31  | x | 0.118 |
| 244270A1               | FM8673          | CARBON PA        | WAFFLE            | 26              | EXT TH    | 143.4 | x | 89.5      | x | 2.5  | 5.65  | x | 3.52  | x | 0.098 |
| 245297A1               | FM3261          | PAPER            | 2 PASS            | 40              | INT TH    | 127.1 | x | 82.2      | x | 2.5  | 5.0   | x | 3.24  | x | 0.098 |
| 291578A1               | FM4995          | PAPER            | 2 PASS/PLAIN      | 54              | EXT TH    | 139.0 | x | 99.0      | x | 2.0  | 5.47  | x | 3.9   | x | 0.077 |
| 291579A1               | FM4993          | PAPER            | 2 PASS            | 54              | EXT TH    | 139.0 | x | 99.0      | x | 2.7  | 5.47  | x | 3.9   | x | 0.104 |
| 291580A1               | FM4998MP        | STEEL            | -----             | 45              | INT TH    | 133.0 | x | 92.7      | x | 2.0  | 5.24  | x | 3.65  | x | 0.079 |
| 299531A1               | FM7689          | PAPER            | WAFFLE            | 10              | EXT LG    | 211.0 | x | 149.4     | x | 2.5  | 8.31  | x | 5.88  | x | 0.098 |



| REPLACES<br>OEM PT.NO. | FMC<br>PART NO. | MATERIAL             | GROOVE<br>DETAILS | TEETH/<br>TANGS | SIZE MM   | SIZE INCH                                 |
|------------------------|-----------------|----------------------|-------------------|-----------------|-----------|---|
| 308029A1               | FM3910MP        | END PLATE            | -----             | 64              | EXT TH    | 230.0 x 151.0 x 9.0 9.06 x 5.94 x 0.354   |
| 308030A1               | FM3912MP        | END PLATE            | -----             | 64              | EXT TH    | 230.0 x 152.5 x 5.0 9.06 x 6.0 x 0.197    |
| 310519A1               | FM3904MP        | END PLATE            | -----             | 6               | EXT LG    | 146.0 x 97.0 x 10.2 5.75 x 3.82 x 0.402   |
| 331386A1               | FM4789          | PAPER/PLAIN          | RADIAL            | 44              | EXT TH    | 158.8 x 111.5 x 1.9 6.25 x 4.39 x 0.075   |
| 331387A1               | FM4787          | CARBON PA            | RADIAL            | 44              | EXT TH    | 158.8 x 111.5 x 2.5 6.25 x 4.39 x 0.098   |
| 331388A1               | FM4790MP        | STEEL                | -----             | 42              | INT TH    | 150.9 x 102.5 x 2.5 5.94 x 4.04 x 0.098   |
| 331420A1               | FM6113          | PAPER/PLAIN          | RADIAL            | 27              | EXT TH    | 137.0 x 93.7 x 1.9 5.39 x 3.69 x 0.073    |
| 331421A1               | FM6111          | CARBON PA            | RADIAL            | 27              | EXT TH    | 137.0 x 93.7 x 2.5 5.39 x 3.69 x 0.098    |
| 331422A1               | FM6116MP        | STEEL                | -----             | 35              | INT TH    | 129.6 x 84.8 x 2.5 5.1 x 3.34 x 0.098     |
| 331893A1               | FM4785          | PAPER/PLAIN          | RADIAL            | 34              | EXT TH    | 177.4 x 111.5 x 1.9 6.98 x 4.39 x 0.075   |
| 331894A1               | FM4783          | CARBON PA            | RADIAL            | 34              | EXT TH    | 177.4 x 111.5 x 2.5 6.98 x 4.39 x 0.098   |
| 331895A1               | FM4786MP        | STEEL                | -----             | 42              | INT TH    | 167.8 x 102.5 x 2.5 6.61 x 4.04 x 0.098   |
| 331896A1               | FM4789          | PAPER/PLAIN          | RADIAL            | 44              | EXT TH    | 158.8 x 111.5 x 1.9 6.25 x 4.39 x 0.075   |
| 331897A1               | FM4787          | CARBON PA            | RADIAL            | 44              | EXT TH    | 158.8 x 111.5 x 2.5 6.25 x 4.39 x 0.098   |
| 335165A1               | FM6781          | CARBON PA            | RADIAL            | 64              | EXT TH    | 196.0 x 142.0 x 2.6 7.72 x 5.59 x 0.1     |
| 335167A1               | FM6783          | CARBON PA            | RADIAL/PLAIN      | 64              | EXT TH    | 196.0 x 142.0 x 2.0 7.72 x 5.59 x 0.079   |
| 345334A2               | FM8677          | CARBON PA            | 2 PASS            | 40              | INT TH    | 134.0 x 81.0 x 3.0 5.28 x 3.19 x 0.116    |
| 345335A2               | FM8680MP        | STEEL                | -----             | 66              | EXT H     | 142.0 x 90.0 x 1.9 5.59 x 3.54 x 0.075    |
| 351175A1               | FM4243          | PAPER                | 3 PASS            | 16              | INT TH    | 301.0 x 54.0 x 6.3 11.85 x 2.13 x 0.248   |
| 351175A2               | FM6853          | CARBON PA            | 3 PASS            | 16              | INT TH    | 301.0 x 54.0 x 6.3 11.85 x 2.13 x 0.248   |
| 352831A1               | FM8501          | PAPER/PLAIN          | WAFFLE            | 88              | EXT TH    | 189.5 x 141.5 x 1.8 7.46 x 5.57 x 0.069   |
| 352832A1               | FM8499          | PAPER                | 2 PASS            | 88              | EXT TH    | 189.5 x 141.5 x 2.2 7.46 x 5.57 x 0.087   |
| 357534A1               | FM3659          | PAPER                | 4 PASS/WAG        | 104             | INT TH    | 437.9 x 325.1 x 5.0 17.24 x 12.8 x 0.197  |
| 362628A1               | FM9172MP        | STEEL                | -----             | 93              | EXT TH    | 239.9 x 171.4 x 2.4 9.44 x 6.75 x 0.094   |
| 362629A1               | FM8514MP        | STEEL                | -----             | 93              | EXT TH    | 240.0 x 171.0 x 2.6 9.45 x 6.73 x 0.102   |
| 366999A1               | FM5271          | OBSOLETE AFTER STOCK |                   | 12              | INT TH    | 274.0 x 45.0 x 6.8 10.79 x 1.77 x 0.268   |
| 367000A1               | FM5274MP        | OBSOLETE AFTER STOCK |                   | 4               | HOLES     | 278.0 x 185.0 x 8.1 10.94 x 7.28 x 0.319  |
| 370555A1               | FM8507          | PAPER/PLAIN          | WAFFLE            | 100             | EXT TH    | 215.0 x 151.5 x 1.8 8.46 x 5.96 x 0.069   |
| 371134A1               | FM5270MP        | STEEL                | -----             | 4               | EXT LG    | 129.0 x 80.3 x 3.5 5.08 x 3.16 x 0.138    |
| 371135A1               | FM5265          | BRONZE               | WAFFLE            | 25              | (31)IN TH | 115.0 x 61.0 x 1.7 4.53 x 2.4 x 0.067     |
| 371136A1               | FM5267          | BRONZE               | WAFFLE/PLAIN      | 25              | (31)IN TH | 115.0 x 61.0 x 3.0 4.53 x 2.4 x 0.118     |
| 381489R3               | FM8320MP        | STEEL                | -----             | 6               | EXT LG    | 145.8 x 103.2 x 1.8 5.74 x 4.06 x 0.069   |
| 381490R4               | FM8317          | CARBON PA            | WAFFLE            | 51              | INT TH    | 134.8 x 95.0 x 2.5 5.31 x 3.74 x 0.098    |
| 384322A1               | FM4183          | PAPER                | WAF/WAG           | 64              | INT TH    | 345.0 x 252.1 x 4.7 13.58 x 9.93 x 0.185  |
| 384323A1               | FM4186MP        | STEEL                | -----             | 20              | EXT LG    | 372.5 x 262.5 x 4.0 14.67 x 10.33 x 0.157 |
| 384388A1               | FM7126-2.9      | STEEL                | HARDENED          | 4               | EXT LG    | 164.8 x 82.4 x 2.9 6.49 x 4.24 x 0.114    |
| 387182A1               | FM4302MP        | STEEL                | -----             | 45              | INT TH    | 170.0 x 132.7 x 3.5 6.69 x 5.22 x 0.138   |
| 387183A1               | FM4300MP        | STEEL                | -----             | 45              | INT TH    | 170.0 x 132.7 x 3.0 6.69 x 5.22 x 0.118   |
| 387184A1               | FM4298MP        | STEEL                | -----             | 45              | INT TH    | 170.0 x 132.7 x 2.5 6.69 x 5.22 x 0.098   |
| 387187A1               | FM8597          | CARBON PA            | RADIAL/PLAIN      | 35              | EXT TH    | 176.5 x 142.0 x 1.9 6.95 x 5.51 x 0.073   |
| 399734R1               | FM3807          | YELLOW               | 2 PASS            | 15              | INT TH    | 259.1 x 51.1 x 7.6 10.2 x 2.01 x 0.3      |
| 399734R1               | FM1765          | RED PAPER            | 2 PASS            | 15              | INT TH    | 259.1 x 51.1 x 7.6 10.2 x 2.01 x 0.3      |
| 399736R3               | FM1836MP        | STEEL                | -----             | 3               | INT LG    | 258.8 x 185.7 x 6.7 10.19 x 7.31 x 0.262  |
| 401716R3               | FM3143          | PAPER                | 2 PASS            | 45              | INT TH    | 125.5 x 93.2 x 2.1 4.94 x 3.67 x 0.082    |
| 401717R1               | FM3148MP        | STEEL                | -----             | 4               | EXT LG    | 139.7 x 98.6 x 1.6 5.5 x 3.88 x 0.062     |
| 413580A1               | FM5270MP        | STEEL                | -----             | 4               | EXT LG    | 129.0 x 80.3 x 3.5 5.08 x 3.16 x 0.138    |
| 413582A1               | FM5265          | BRONZE               | WAFFLE            | 25              | (31)IN TH | 115.0 x 61.0 x 1.7 4.53 x 2.4 x 0.067     |
| 413583A1               | FM5267          | BRONZE               | WAFFLE/PLAIN      | 25              | (31)IN TH | 115.0 x 61.0 x 3.0 4.53 x 2.4 x 0.118     |

| REPLACES<br>OEM PT.NO. | FMC<br>PART NO. | MATERIAL             | GROOVE<br>DETAILS | TEETH/<br>TANGS | SIZE MM   |       |   | SIZE INCH |   |      |       |   |      |   |       |
|------------------------|-----------------|----------------------|-------------------|-----------------|-----------|-------|---|-----------|---|------|-------|---|------|---|-------|
| 413586A1               | FM5271          | OBSOLETE AFTER STOCK |                   | 12              | INT TH    | 274.0 | x | 45.0      | x | 6.8  | 10.79 | x | 1.77 | x | 0.268 |
| 423374A1               | FM7779          | PAPER                | 2 PASS            | 18              | INT TH    | 154.7 | x | 34.2      | x | 4.9  | 6.09  | x | 1.35 | x | 0.193 |
| 452160A1               | FM3095          | GRAPHITE             | SUNBURST          | 13              | INT TH    | 215.0 | x | 36.5      | x | 10.0 | 8.46  | x | 1.44 | x | 0.394 |
| 533804R1               | FM3143          | PAPER                | 2 PASS            | 45              | INT TH    | 125.5 | x | 93.2      | x | 2.1  | 4.94  | x | 3.67 | x | 0.082 |
| 716556A1               | FM8677          | CARBON PA            | 2 PASS            | 40              | INT TH    | 134.0 | x | 81.0      | x | 3.0  | 5.28  | x | 3.19 | x | 0.116 |
| 984439C1               | FM1836MP        | STEEL                | -----             | 3               | INT LG    | 258.8 | x | 185.7     | x | 6.7  | 10.19 | x | 7.31 | x | 0.262 |
| 1027256C1              | FM3807          | YELLOW               | 2 PASS            | 15              | INT TH    | 259.1 | x | 51.1      | x | 7.6  | 10.2  | x | 2.01 | x | 0.3   |
| 1027256C1              | FM1765          | RED PAPER            | 2 PASS            | 15              | INT TH    | 259.1 | x | 51.1      | x | 7.6  | 10.2  | x | 2.01 | x | 0.3   |
| 1263329H1              | FM3575          | PAPER                | 3 PASS            | 35              | INT TH    | 179.0 | x | 103.0     | x | 3.5  | 7.05  | x | 4.05 | x | 0.138 |
| 1276804H1              | FM3948MP        | STEEL                | -----             | 67              | (70)EX TH | 191.0 | x | 130.0     | x | 2.5  | 7.52  | x | 5.12 | x | 0.098 |
| 1276805H1              | FM3946MP        | STEEL                | -----             | 67              | (70)EX TH | 191.0 | x | 130.0     | x | 3.0  | 7.52  | x | 5.12 | x | 0.118 |
| 1285974C1              | FM8328MP        | STEEL                | -----             | 8               | EXT LG    | 244.0 | x | 173.0     | x | 2.3  | 9.61  | x | 8.81 | x | 0.091 |
| 1285975C2              | FM8325          | CARBON PA            | WAFFLE            | 39              | INT TH    | 228.0 | x | 162.0     | x | 2.9  | 8.98  | x | 6.38 | x | 0.114 |
| 1335324C1              | FM7211          | PAPER                | WAFFLE            | 34              | INT TH    | 99.7  | x | 68.0      | x | 1.6  | 3.93  | x | 2.68 | x | 0.063 |
| 1341163C3              | FM8788MP        | STEEL                | -----             | 2               | EXT LG    | 175.0 | x | 90.7      | x | 5.4  | 6.89  | x | 3.57 | x | 0.213 |
| 13411170C1             | FM9117          | PAPER                | 2 PASS            | 16              | INT TH    | 143.0 | x | 63.5      | x | 6.4  | 5.63  | x | 2.5  | x | 0.252 |
| 1342285C1              | FM2841          | BRONZE               | SPR/RAD           | 19              | INT TH    | 203.2 | x | 57.2      | x | 4.7  | 8.0   | x | 2.25 | x | 0.185 |
| 1345726C1              | FM6295          | IRON                 | 2 PASS            | 16              | INT TH    | 143.0 | x | 63.5      | x | 6.3  | 5.63  | x | 2.5  | x | 0.248 |
| 1362618A1              | FM8511          | PAPER                | WAFFLE            | 62              | INT TH    | 228.5 | x | 155.0     | x | 2.2  | 9.0   | x | 6.1  | x | 0.087 |
| 1966154C1              | FM2971          | BRONZE               | WAFFLE            | 22              | INT TH    | 71.7  | x | 44.0      | x | 2.8  | 2.82  | x | 1.73 | x | 0.11  |
| 1966155C1              | FM3474MP        | STEEL                | -----             | 4               | EXT LG    | 85.0  | x | 49.2      | x | 1.5  | 3.35  | x | 1.94 | x | 0.059 |
| 1966156C1              | FM2969          | BRONZE               | WAFFLE            | 22              | INT TH    | 71.7  | x | 44.0      | x | 1.6  | 2.82  | x | 1.73 | x | 0.063 |
| 1997122C1              | FM3902MP        | END PLATE            | -----             | 26              | EXT TH    | 143.4 | x | 89.5      | x | 10.9 | 5.65  | x | 3.52 | x | 0.429 |
| 1997129C1              | FM8901          | PAPER                | WAFFLE            | 40              | INT TH    | 127.1 | x | 82.2      | x | 2.5  | 5.0   | x | 3.24 | x | 0.098 |
| 1997907C1              | FM8333          | PAPER                | WAFFLE            | 48              | INT TH    | 141.0 | x | 99.0      | x | 2.0  | 5.55  | x | 3.9  | x | 0.079 |
| 3125147R1              | FM3146MP        | STEEL                | -----             | 6               | EXT LG    | 139.7 | x | 98.6      | x | 2.0  | 5.5   | x | 3.88 | x | 0.78  |
| 3125322R2              | FM3143          | PAPER                | 2 PASS            | 45              | INT TH    | 125.5 | x | 93.2      | x | 2.1  | 4.94  | x | 3.67 | x | 0.082 |
| 3145546R91             | FM2389          | PAPER                | WAFFLE            | 10              | INT TH    | 226.7 | x | 48.3      | x | 8.9  | 8.92  | x | 1.9  | x | 0.35  |
| 3220450R91             | FM2391          | PAPER                | WAFFLE            | 10              | INT TH    | 255.4 | x | 48.3      | x | 8.9  | 10.05 | x | 1.9  | x | 0.35  |
| 3380997H1              | FM3948MP        | STEEL                | -----             | 67              | (70)EX TH | 191.0 | x | 130.0     | x | 2.5  | 7.52  | x | 5.12 | x | 0.098 |
| 3380999H1              | FM3575          | PAPER                | 3 PASS            | 35              | INT TH    | 179.0 | x | 103.0     | x | 3.5  | 7.05  | x | 4.05 | x | 0.138 |
| 370556A1               | FM8505          | PAPER                | 2 PASS            | 100             | EXT TH    | 215.0 | x | 151.5     | x | 2.2  | 8.46  | x | 5.96 | x | 0.087 |
| 8603203                | FM4449          | MOLYBDENUM           | SPR/WAG           | 26              | INT TH    | 147.8 | x | 75.4      | x | 3.0  | 5.82  | x | 2.97 | x | 0.118 |
| 152402252              | FM4336MP        | STEEL                | -----             | 28              | INT TH    | 127.0 | x | 79.0      | x | 1.8  | 5.0   | x | 3.11 | x | 0.071 |
| 152402253              | FM2865          | BRONZE               | SUNBURST          | 64              | EXT TH    | 138.8 | x | 95.2      | x | 2.8  | 5.46  | x | 3.75 | x | 0.11  |
| 153317478              | FM3575          | PAPER                | 3 PASS            | 35              | INT TH    | 179.0 | x | 103.0     | x | 3.5  | 7.05  | x | 4.05 | x | 0.138 |
| 153318841              | FM2815          | PAPER                | 4 PASS            | 42              | INT TH    | 340.0 | x | 206.0     | x | 5.5  | 13.39 | x | 8.11 | x | 0.217 |
| 8900126635             | FM4286MP        | STEEL                | -----             | 45              | INT TH    | 185.0 | x | 132.7     | x | 3.5  | 7.28  | x | 5.22 | x | 0.138 |
| 8900126636             | FM4288MP        | STEEL                | -----             | 45              | INT TH    | 185.0 | x | 132.7     | x | 4.0  | 7.28  | x | 5.22 | x | 0.157 |
| 8900126637             | FM4282MP        | STEEL                | -----             | 45              | INT TH    | 185.0 | x | 132.7     | x | 2.5  | 7.28  | x | 5.22 | x | 0.098 |
| 8900126638             | FM4284MP        | STEEL                | -----             | 45              | INT TH    | 185.0 | x | 132.7     | x | 3.0  | 7.28  | x | 5.22 | x | 0.118 |
| 8900126641             | FM6781          | CARBON PA            | RADIAL            | 64              | EXT TH    | 196.0 | x | 142.0     | x | 2.6  | 7.72  | x | 5.59 | x | 0.1   |
| 8900126642             | FM6783          | CARBON PA            | RADIAL/PLAIN      | 64              | EXT TH    | 196.0 | x | 142.0     | x | 2.0  | 7.72  | x | 5.59 | x | 0.079 |
| 8900126648             | FM8595          | CARBON PA            | RADIAL            | 35              | EXT TH    | 176.5 | x | 142.0     | x | 2.5  | 6.95  | x | 5.51 | x | 0.096 |
| 8900130483             | FM4296MP        | STEEL                | -----             | 45              | INT TH    | 170.0 | x | 132.7     | x | 2.0  | 6.69  | x | 5.22 | x | 0.077 |
| 8900130484             | FM6444MP        | STEEL                | HARD/BLACK        | 45              | INT TH    | 170.0 | x | 132.7     | x | 2.5  | 6.69  | x | 5.22 | x | 0.098 |
| 8900130485             | FM6446MP        | STEEL                | HARD/BLACK        | 45              | INT TH    | 170.0 | x | 132.7     | x | 3.0  | 6.69  | x | 5.22 | x | 0.118 |

| REPLACES<br>OEM PT.NO. | FMC<br>PART NO. | MATERIAL    | GROOVE<br>DETAILS | TEETH/<br>TANGS |        | SIZE MM |   |       | SIZE INCH |     |       |   |      |   |       |
|------------------------|-----------------|-------------|-------------------|-----------------|--------|---------|---|-------|-----------|-----|-------|---|------|---|-------|
| 8900130488             | FM4289          | BRONZE      | SPR/RAD           | 35              | EXT TH | 176.5   | x | 142.0 | x         | 2.5 | 6.95  | x | 5.51 | x | 0.096 |
| 8900120489             | FM4291          | BRNZ/PLN    | SPR/RAD           | 35              | EXT TH | 176.5   | x | 142.0 | x         | 2.0 | 6.95  | x | 5.51 | x | 0.077 |
| 133000340016           | FM8483          | GRAPHITE    | SUN/RAD           | 28              | INT TH | 242.6   | x | 56.1  | x         | 4.8 | 9.55  | x | 2.21 | x | 0.189 |
| 133000340022           | FM7274MP        | STEEL       | -----             | 2               | EXT LG | 288.0   | x | 156.0 | x         | 3.0 | 11.34 | x | 6.14 | x | 0.118 |
|                        |                 |             |                   |                 |        |         |   |       |           |     |       |   |      |   |       |
| 133000341001           | FM8483          | GRAPHITE    | SUN/RAD           | 28              | INT TH | 242.6   | x | 56.1  | x         | 4.8 | 9.55  | x | 2.21 | x | 0.189 |
| 133100340013           | FM8483          | GRAPHITE    | SUN/RAD           | 28              | INT TH | 242.6   | x | 56.1  | x         | 4.8 | 9.55  | x | 2.21 | x | 0.189 |
| 33-1518-T2             | FM7213          | PAPER       | 2 PASS            | 88              | EXT TH | 189.5   | x | 141.7 | x         | 3.1 | 7.46  | x | 5.58 | x | 0.12  |
| S2080 S00F             | FM8504MP        | STEEL       | -----             | 52              | INT TH | 177.0   | x | 130.0 | x         | 2.4 | 6.97  | x | 5.12 | x | 0.094 |
| S2090 S00F             | FM9170MP        | STEEL       | -----             | 52              | INT TH | 178.0   | x | 129.6 | x         | 2.1 | 7.01  | x | 5.1  | x | 0.083 |
|                        |                 |             |                   |                 |        |         |   |       |           |     |       |   |      |   |       |
| S4070 S00F             | FM8510MP        | STEEL       | -----             | 56              | INT TH | 204.0   | x | 139.8 | x         | 2.4 | 8.03  | x | 5.5  | x | 0.094 |
| S4110 S00F             | FM9174MP        | STEEL       | -----             | 56              | INT TH | 204.0   | x | 139.8 | x         | 2.1 | 8.03  | x | 5.5  | x | 0.083 |
| EW205 0S02F            | FM7213          | PAPER       | 2 PASS            | 88              | EXT TH | 189.5   | x | 141.7 | x         | 3.1 | 7.46  | x | 5.58 | x | 0.12  |
| EW208 0S00F            | FM8504MP        | STEEL       | -----             | 52              | INT TH | 177.0   | x | 130.0 | x         | 2.4 | 6.97  | x | 5.12 | x | 0.094 |
| EW209 0S00F            | FM9170MP        | STEEL       | -----             | 52              | INT TH | 178.0   | x | 129.6 | x         | 2.1 | 7.01  | x | 5.1  | x | 0.083 |
|                        |                 |             |                   |                 |        |         |   |       |           |     |       |   |      |   |       |
| EW407 0S00F            | FM8510MP        | STEEL       | -----             | 56              | INT TH | 204.0   | x | 139.8 | x         | 2.4 | 8.03  | x | 5.5  | x | 0.094 |
| EW411 0S00F            | FM9174MP        | STEEL       | -----             | 56              | INT TH | 204.0   | x | 139.8 | x         | 2.1 | 8.03  | x | 5.5  | x | 0.083 |
| EW512 0S00F            | FM8514MP        | STEEL       | -----             | 93              | EXT TH | 240.0   | x | 171.0 | x         | 2.6 | 9.45  | x | 6.73 | x | 0.102 |
| PS205 AA00A            | FM8499          | PAPER       | 2 PASS            | 88              | EXT TH | 189.5   | x | 141.5 | x         | 2.2 | 7.46  | x | 5.57 | x | 0.087 |
| PS206 AA00A            | FM8501          | PAPER/PLAIN | WAFFLE            | 88              | EXT TH | 189.5   | x | 141.5 | x         | 1.8 | 7.46  | x | 5.57 | x | 0.069 |
|                        |                 |             |                   |                 |        |         |   |       |           |     |       |   |      |   |       |
| PS408 AA01B            | FM8511          | PAPER       | WAFFLE            | 62              | INT TH | 228.5   | x | 155.0 | x         | 2.2 | 9.0   | x | 6.1  | x | 0.087 |
| PS411 AA00A            | FM9172MP        | STEEL       | -----             | 93              | EXT TH | 239.9   | x | 171.4 | x         | 2.4 | 9.44  | x | 6.75 | x | 0.094 |
| PS508 AA00A            | FM8505          | PAPER       | 2 PASS            | 100             | EXT TH | 215.0   | x | 151.5 | x         | 2.2 | 8.46  | x | 5.96 | x | 0.087 |
| PS573 AA00A            | FM8507          | PAPER/PLAIN | WAFFLE            | 100             | EXT TH | 215.0   | x | 151.5 | x         | 1.8 | 8.46  | x | 5.96 | x | 0.069 |



# Caterpillar 777 Transmission Discs

---



| REPLACES<br>OEM PT.NO. | FMC<br>PART NO. | MATERIAL  | GROOVE<br>DETAILS | TEETH/<br>TANGS | SIZE MM     |       |   | SIZE INCH |   |     |       |   |       |   |       |
|------------------------|-----------------|-----------|-------------------|-----------------|-------------|-------|---|-----------|---|-----|-------|---|-------|---|-------|
| <b>CATERPILLAR</b>     |                 |           |                   |                 |             |       |   |           |   |     |       |   |       |   |       |
| 1A3987                 | FM1644MP        | STEEL     | -----             | 88              | INT TH      | 365.8 | x | 273.1     | x | 2.3 | 14.4  | x | 10.75 | x | 0.09  |
| 2A3616                 | OBSOLETE        | STEEL     | -----             | 3               | INT LUG     | 75.9  | x | 35.3      | x | 1.6 | 2.99  | x | 1.39  | x | 0.063 |
| 6A6486                 | FM3257          | PAPER     | WAFFLE            | 18              | INT TH      | 110.0 | x | 54.0      | x | 5.2 | 4.33  | x | 2.13  | x | 0.205 |
| 1B9746                 | FM2360MP        | STEEL     | -----             | 88              | INT TH      | 393.7 | x | 273.1     | x | 2.3 | 15.5  | x | 10.75 | x | 0.09  |
| 2B3788                 | OBSOLETE        | BRONZE    | -----             | 128             | EXT TH      | 412.2 | x | 292.1     | x | 4.7 | 16.23 | x | 11.5  | x | 0.187 |
| 2B5199                 | FM0427          | OBSOLETE  | -----             | 104             | EXT TH      | 335.8 | x | 215.9     | x | 5.8 | 13.22 | x | 8.5   | x | 0.23  |
| 2B8955                 | FM1882MP        | STEEL     | -----             | 63              | INT TH      | 289.1 | x | 193.8     | x | 2.3 | 11.38 | x | 7.63  | x | 0.09  |
| 3B7974                 | FM1605          | OBSOLETE  | -----             | 128             | EXT TH      | 412.2 | x | 292.1     | x | 4.7 | 16.23 | x | 11.5  | x | 0.187 |
| 4B3532                 | FM3072MP        | STEEL     | -----             | 77              | INT TH      | 241.3 | x | 158.8     | x | 1.6 | 9.5   | x | 6.25  | x | 0.63  |
| 4B3533                 | FM1607          | BRONZE    | -----             | 119             | EXT TH      | 254.0 | x | 171.5     | x | 4.7 | 10.0  | x | 6.75  | x | 0.187 |
| 4B4982                 | FM1603          | BRONZE    | -----             | 120             | EXT TH      | 384.8 | x | 292.6     | x | 4.7 | 15.15 | x | 11.52 | x | 0.187 |
| 8B2864                 | FM1603          | BRONZE    | -----             | 120             | EXT TH      | 384.8 | x | 292.6     | x | 4.7 | 15.15 | x | 11.52 | x | 0.187 |
| 5C0857                 | FM5802MP        | STEEL     | -----             | 37              | EXT TH      | 119.6 | x | 69.9      | x | 2.8 | 4.71  | x | 2.75  | x | 0.11  |
| 8C7448                 | FM3813          | TAN PAPER | 2 PASS            | 50              | (52) INT TH | 148.6 | x | 107.7     | x | 2.7 | 5.85  | x | 4.24  | x | 0.108 |
| 8C7448                 | FM5295          | GREEN PA  | 2 PASS            | 50              | (52) INT TH | 148.6 | x | 107.7     | x | 2.7 | 5.85  | x | 4.24  | x | 0.108 |
| 9C6329                 | FM6064MP        | PISTON    | -----             |                 |             |       |   |           |   |     |       |   |       |   |       |
| 5D6327                 | FM1700MP        | STEEL     | -----             | 100             | EXT TH      | 514.9 | x | 328.7     | x | 2.4 | 20.27 | x | 12.94 | x | 0.095 |
| 5D6328                 | FM1471          | CORK      | -----             | 100             | EXT TH      | 514.9 | x | 328.7     | x | 6.9 | 20.27 | x | 12.94 | x | 0.27  |
| 5D6329                 | FM1963          | PAPER     | 3 PASS            | 62              | INT TH      | 495.3 | x | 308.1     | x | 5.1 | 19.5  | x | 12.13 | x | 0.2   |
| 5D8526                 | FM2368MP        | STEEL     | -----             | 44              | EXT TH      | 113.5 | x | 86.1      | x | 0.8 | 4.47  | x | 3.39  | x | 0.032 |
| 6D2348                 | FM1745          | CORK      | SPIRAL            | 64              | INT TH      | 381.0 | x | 197.6     | x | 5.5 | 15.0  | x | 7.78  | x | 0.215 |
| 6D2358                 | FM2365          | PAPER     | 2 PASS            | 18              | INT TH      | 105.9 | x | 43.4      | x | 2.5 | 4.17  | x | 1.71  | x | 0.1   |
| 6D4535                 | FM4234MP        | STEEL     | -----             | 46              | INT TH      | 118.7 | x | 74.7      | x | 0.8 | 4.67  | x | 2.94  | x | 0.031 |
| 6D4536                 | FM3075          | PAPER     | 2 PASS            | 45              | INT TH      | 112.0 | x | 70.0      | x | 2.1 | 4.41  | x | 2.76  | x | 0.083 |
| 6D8977                 | FM3433          | PAPER     | 2 PASS            | 30              | INT TH      | 106.0 | x | 46.2      | x | 2.5 | 4.17  | x | 1.82  | x | 0.98  |
| 7D3012                 | FM2048MP        | STEEL     | -----             | 144             | EXT TH      | 737.9 | x | 539.8     | x | 2.5 | 29.05 | x | 21.25 | x | 0.1   |
| 7D3013                 | FM2045          | CORK      | -----             | 144             | EXT TH      | 737.9 | x | 539.8     | x | 6.9 | 29.05 | x | 21.25 | x | 0.27  |
| 7D3014                 | FM2071          | PAPER     | 3 PASS            | 102             | INT TH      | 715.3 | x | 511.3     | x | 5.1 | 28.16 | x | 20.13 | x | 0.2   |
| 7D7504                 | FM1700MP        | STEEL     | -----             | 100             | EXT TH      | 514.9 | x | 328.7     | x | 2.4 | 20.27 | x | 12.94 | x | 0.095 |
| 7D7671                 | FM2048MP        | STEEL     | -----             | 144             | EXT TH      | 737.9 | x | 539.8     | x | 2.5 | 29.05 | x | 21.25 | x | 0.1   |
| 7D8185                 | FM2920MP        | STEEL     | -----             | 91              | EXT TH      | 232.6 | x | 170.0     | x | 1.5 | 9.16  | x | 6.69  | x | 0.059 |
| 7D8434                 | FM1454MP        | STEEL     | -----             | 100             | EXT TH      | 322.8 | x | 226.6     | x | 1.9 | 12.71 | x | 8.92  | x | 0.075 |
| 8D1647                 | FM1413          | PAPER     | 2 PASS            | 88              | INT TH      | 407.9 | x | 274.1     | x | 3.8 | 16.06 | x | 10.79 | x | 0.15  |
| 8D1648                 | FM1456MP        | STEEL     | -----             | 132             | EXT TH      | 422.7 | x | 302.5     | x | 2.3 | 16.64 | x | 11.91 | x | 0.091 |
| 8D2421                 | FM1407          | PAPER     | 2 PASS            | 64              | INT TH      | 306.6 | x | 198.4     | x | 3.5 | 12.07 | x | 7.81  | x | 0.136 |
| 8D3879                 | FM6210MP        | STEEL     | -----             | 94              | EXT TH      | 300.0 | x | 227.0     | x | 1.9 | 11.81 | x | 8.94  | x | 0.075 |
| 8D3888                 | FM6207          | PAPER     | 2 PASS            | 52              | INT TH      | 294.0 | x | 161.0     | x | 3.5 | 11.57 | x | 6.34  | x | 0.138 |
| 8D4236                 | FM2917          | PAPER     | 2 PASS            | 50              | INT TH      | 225.7 | x | 155.9     | x | 2.9 | 8.89  | x | 6.14  | x | 0.114 |
| 8D8794                 | FM1458MP        | STEEL     | -----             | 86              | EXT TH      | 276.9 | x | 187.5     | x | 1.5 | 10.9  | x | 7.38  | x | 0.059 |
| 8D8796                 | FM1405          | PAPER     | 2 PASS            | 54              | INT TH      | 255.5 | x | 168.4     | x | 2.8 | 10.06 | x | 6.63  | x | 0.112 |
| 8D9718                 | FM3302MP        | STEEL     | -----             | 78              | EXT TH      | 199.2 | x | 137.0     | x | 1.4 | 7.84  | x | 5.39  | x | 0.055 |
| 8D9719                 | FM3237          | PAPER     | 2 PASS            | 40              | INT TH      | 192.9 | x | 124.1     | x | 2.9 | 7.59  | x | 4.89  | x | 0.114 |
| 4E7519                 | FM5492MP        | STEEL     | -----             | 4               | EXT LG      | 379.2 | x | 209.5     | x | 6.7 | 14.93 | x | 8.25  | x | 0.266 |
| 8E0401                 | FM5958MP        | STEEL     | -----             | 30              | EXT TH      | 200.5 | x | 140.0     | x | 4.0 | 7.89  | x | 5.51  | x | 0.157 |
| 8E0682                 | FM3656MP        | STEEL     | -----             | 54              | EXT TH      | 139.0 | x | 99.0      | x | 4.0 | 5.47  | x | 3.9   | x | 0.157 |
| 8E0684                 | FM4075          | BRONZE    | 4 PASS            | 114             | INT TH      | 412.0 | x | 285.0     | x | 4.9 | 16.22 | x | 11.22 | x | 0.193 |
| 8E0985                 | FM6131          | ELASTOMER | SPR/RAD/WAG       | 101             | INT TH      | 534.0 | x | 417.0     | x | 5.6 | 21.02 | x | 16.42 | x | 0.22  |

| REPLACES<br>OEM PT.NO. | FMC<br>PART NO. | MATERIAL  | GROOVE<br>DETAILS | TEETH/<br>TANGS | SIZE MM   |       |   | SIZE INCH |   |      |       |   |       |   |       |
|------------------------|-----------------|-----------|-------------------|-----------------|-----------|-------|---|-----------|---|------|-------|---|-------|---|-------|
| ALTERNATIVE            | FM7547          | CARBON    | WAFFLE            | 101             | INT TH    | 534.0 | x | 417.0     | x | 5.6  | 21.02 | x | 16.42 | x | 0.22  |
| 8E1204                 | FM2643          | PAPER     | 2 PASS            | 40              | EXT TH    | 280.4 | x | 200.0     | x | 4.3  | 11.04 | x | 7.87  | x | 0.169 |
| 8E1459                 | FM3658MP        | STEEL     | -----             | 54              | EXT TH    | 139.0 | x | 99.0      | x | 2.0  | 5.47  | x | 3.9   | x | 0.079 |
| 8E2153                 | FM3249          | ELASTOMER | SPR/RAD           | 52              | INT TH    | 160.0 | x | 108.0     | x | 4.0  | 6.3   | x | 4.25  | x | 0.157 |
| 8E2183                 | FM2433          | PAPER     | 3 PASS            | 80              | INT TH    | 540.0 | x | 400.0     | x | 5.1  | 21.26 | x | 15.74 | x | 0.2   |
| 8E2729                 | FM4157          | ELASTOMER | SPR/RAD/WAG       | 80              | INT TH    | 432.1 | x | 337.8     | x | 5.6  | 17.01 | x | 13.3  | x | 0.22  |
| ALTERNATIVE            | FM6283          | CARBON    | WAFFLE            | 80              | INT TH    | 432.1 | x | 337.8     | x | 5.6  | 17.01 | x | 13.3  | x | 0.22  |
| 8E3980                 | FM3650MP        | STEEL     | -----             | 54              | EXT TH    | 139.2 | x | 98.6      | x | 3.0  | 5.48  | x | 3.88  | x | 0.118 |
| 8E4075                 | FM2701          | ORGANIC   | -----             | 71              | EXT TH    | 303.5 | x | 213.0     | x | 4.9  | 11.95 | x | 8.38  | x | 0.193 |
| 8E4526                 | FM2375          | CARBON PA | SUNBURST          | 88              | INT TH    | 393.7 | x | 273.3     | x | 4.7  | 15.5  | x | 10.76 | x | 0.185 |
| 8E5556                 | FM3254MP        | STEEL     | -----             | 52              | EXT TH    | 168.0 | x | 98.6      | x | 3.0  | 6.61  | x | 3.88  | x | 0.118 |
| 8E5621                 | FM3266MP        | STEEL     | -----             | 6               | EXT LG    | 606.0 | x | 454.0     | x | 6.4  | 23.86 | x | 17.87 | x | 0.25  |
| 8E5622                 | FM3564MP        | STEEL     | -----             | 6               | EXT LG    | 607.0 | x | 454.0     | x | 6.4  | 23.9  | x | 17.87 | x | 0.25  |
| 8E5707                 | FM7630MP        | END PLATE | STEPPED           | 54              | EXT TH    | 138.8 | x | 99.1      | x | 12.0 | 5.46  | x | 3.9   | x | 0.472 |
| 8E5820                 | FM1641          | ORGANIC   | -----             |                 | LINING    | 137.2 | x | 31.8      | x | 4.7  | 5.4   | x | 1.25  | x | 0.185 |
| 8E6115                 | FM7422MP        | STEEL     | -----             | 36              | EXT TH    | 170.0 | x | 117.5     | x | 2.2  | 6.69  | x | 4.63  | x | 0.087 |
| 8E6931                 | FM1657B         | BRONZE    | SPR/RAD           | 45              | INT TH    | 133.4 | x | 92.7      | x | 2.1  | 5.25  | x | 3.65  | x | 0.082 |
| 8E6937                 | FM1307OE        | BRONZE    | RADIAL            | 52              | INT TH    | 148.6 | x | 107.7     | x | 2.6  | 5.85  | x | 4.24  | x | 0.102 |
| 8E6938                 | FM1216MP        | STEEL     | -----             | 60              | EXT TH    | 154.2 | x | 113.8     | x | 1.8  | 6.07  | x | 4.48  | x | 0.07  |
| 8E6942                 | FM7196MP        | STEEL     | -----             | 16              | (24)EX TH | 257.2 | x | 190.6     | x | 1.9  | 10.13 | x | 7.5   | x | 0.075 |
| 8E6961                 | FM2383          | GRAPHITE  | 2 PASS            | 72              | INT TH    | 233.4 | x | 175.5     | x | 4.0  | 9.19  | x | 6.91  | x | 0.156 |
| 8E7628                 | FM1607          | BRONZE    | -----             | 119             | EXT TH    | 254.0 | x | 171.5     | x | 4.7  | 10.0  | x | 6.75  | x | 0.187 |
| 8E8328                 | FM3435          | PAPER     | 2 PASS            | 114             | INT TH    | 412.0 | x | 286.0     | x | 4.8  | 16.22 | x | 11.26 | x | 0.189 |
| 8E8832                 | FM1279          | PAPER     | 2 PASS            | 52              | INT TH    | 148.6 | x | 107.7     | x | 1.8  | 5.85  | x | 4.24  | x | 0.07  |
| 8E9846                 | FM2168MP        | STEEL     | -----             | 6               | EXT LG    | 336.0 | x | 233.4     | x | 3.2  | 13.23 | x | 9.19  | x | 0.125 |
| 8E9849                 | FM4431          | ELASTOMER | SPE/RAD/WAG       | 61              | INT TH    | 281.7 | x | 220.0     | x | 4.9  | 11.09 | x | 8.66  | x | 0.193 |
| 2F8621                 | FM1603          | BRONZE    | -----             | 120             | EXT TH    | 384.8 | x | 292.6     | x | 4.7  | 15.15 | x | 11.52 | x | 0.187 |
| 3F5504                 | FM1601          | BRONZE    | -----             | 95              | EXT TH    | 305.6 | x | 212.6     | x | 4.7  | 12.03 | x | 8.37  | x | 0.187 |
| 3F9073                 | FM1882MP        | STEEL     | -----             | 63              | INT TH    | 289.1 | x | 193.8     | x | 2.3  | 11.38 | x | 7.63  | x | 0.09  |
| 4F1856                 | FM1607          | BRONZE    | -----             | 119             | EXT TH    | 254.0 | x | 171.5     | x | 4.7  | 10    | x | 6.75  | x | 0.187 |
| 8F4453                 | FM2378MP        | STEEL     | -----             | 8               | INT LG    | 393.7 | x | 273.8     | x | 2.4  | 15.5  | x | 10.78 | x | 0.094 |
| 2G0475                 | FM2835          | PAPER     | -----             | 74              | INT TH    | 178.0 | x | 116.4     | x | 2.9  | 7.01  | x | 4.58  | x | 0.114 |
| 2G0478                 | FM2838MP        | STEEL     | -----             | 44              | EXT TH    | 189.0 | x | 124.0     | x | 1.5  | 7.44  | x | 4.88  | x | 0.057 |
| 2G9908                 | FM1405          | PAPER     | 2 PASS            | 54              | INT TH    | 255.5 | x | 168.4     | x | 2.8  | 10.06 | x | 6.63  | x | 0.112 |
| 2G9909                 | FM1407          | PAPER     | 2 PASS            | 64              | INT TH    | 306.6 | x | 198.4     | x | 3.5  | 12.07 | x | 7.81  | x | 0.136 |
| 2G9911                 | FM1413          | PAPER     | 2 PASS            | 88              | INT TH    | 407.9 | x | 274.1     | x | 3.8  | 16.06 | x | 10.79 | x | 0.15  |
| 6G6500                 | FM2475          | CORK      | -----             | 176             | EXT TH    | 900.7 | x | 692.2     | x | 6.9  | 35.46 | x | 27.25 | x | 0.27  |
| 7G0437                 | FM2168MP        | STEEL     | -----             | 6               | EXT LG    | 336.0 | x | 233.4     | x | 3.2  | 13.23 | x | 9.19  | x | 0.125 |
| 7G0824                 | FM4496MP        | STEEL     | -----             | 51              | EXT TH    | 357.0 | x | 283.0     | x | 5.0  | 14.06 | x | 11.14 | x | 0.197 |
| 7G0825                 | FM5988MP        | STEEL     | -----             | 5               | EXT LG    | 415.4 | x | 320.0     | x | 6.4  | 16.35 | x | 12.6  | x | 0.25  |
| 7G1252                 | FM4806MP        | STEEL     | -----             | 142             | EXT TH    | 452.0 | x | 344.0     | x | 2.3  | 17.8  | x | 13.54 | x | 0.09  |
| 7G1968                 | FM3650MP        | STEEL     | -----             | 54              | EXT TH    | 139.2 | x | 98.6      | x | 3.0  | 5.48  | x | 3.88  | x | 0.118 |
| 7G1969                 | FM3650MP        | STEEL     | -----             | 54              | EXT TH    | 139.2 | x | 98.6      | x | 3.0  | 5.48  | x | 3.88  | x | 0.118 |
| 7G2828                 | FM3166MP        | STEEL     | -----             | 4               | EXT LG    | 329.0 | x | 186.0     | x | 5.0  | 12.95 | x | 7.32  | x | 0.197 |
| 7G3129                 | FM2243          | PAPER     | SPR/RAD           | 75              | INT TH    | 344.9 | x | 271.0     | x | 5.6  | 13.58 | x | 10.67 | x | 0.222 |
| 7G5377                 | FM2448MP        | STEEL     | -----             | 60              | EXT TH    | 154.2 | x | 113.8     | x | 3.1  | 6.07  | x | 4.48  | x | 0.123 |
| 7G8107                 | FM1247OE        | BRONZE    | SUNBURST          | 43              | (44)IN TH | 196.9 | x | 137.7     | x | 2.8  | 7.75  | x | 5.42  | x | 0.109 |
| 7G8542                 | FM2829          | PAPER     | 2 PASS            | 45              | INT TH    | 133.1 | x | 92.7      | x | 2.1  | 5.24  | x | 3.65  | x | 0.083 |

| REPLACES<br>OEM PT.NO. | FMC<br>PART NO. | MATERIAL  | GROOVE<br>DETAILS | TEETH/<br>TANGS | SIZE MM    |       |   | SIZE INCH |   |     |       |   |       |   |       |
|------------------------|-----------------|-----------|-------------------|-----------------|------------|-------|---|-----------|---|-----|-------|---|-------|---|-------|
| 8G3420                 | FM2881          | PAPER     | 3 PASS            | 58              | INT TH     | 266.2 | x | 181.6     | x | 4.8 | 10.48 | x | 7.15  | x | 0.19  |
| 8G4510                 | FM2884MP        | STEEL     | -----             | 86              | EXT TH     | 275.6 | x | 192.0     | x | 2.3 | 10.85 | x | 7.56  | x | 0.091 |
| 8G4511                 | FM2848MP        | STEEL     | -----             | 126             | EXT TH     | 402.0 | x | 338.0     | x | 2.3 | 15.83 | x | 13.3  | x | 0.091 |
| 9G1303                 | FM1279          | PAPER     | 2 PASS            | 52              | INT TH     | 148.6 | x | 107.7     | x | 1.8 | 5.85  | x | 4.24  | x | 0.07  |
| 9G2407                 | FM6131          | ELASTOMER | SPR/RAD/WAG       | 101             | INT TH     | 534.0 | x | 417.0     | x | 5.6 | 21.02 | x | 16.42 | x | 0.22  |
| ALTERNATIVE            | FM7547          | CARBON    | WAFFLE            | 101             | INT TH     | 534.0 | x | 417.0     | x | 5.6 | 21.02 | x | 16.42 | x | 0.22  |
| 9G2408                 | FM4157          | ELASTOMER | SPR/RAD/WAG       | 80              | INT TH     | 432.1 | x | 337.8     | x | 5.6 | 17.01 | x | 13.3  | x | 0.22  |
| ALTERNATIVE            | FM6283          | CARBON    | WAFFLE            | 80              | INT TH     | 432.1 | x | 337.8     | x | 5.6 | 17.01 | x | 13.3  | x | 0.22  |
| 9G4400                 | FM2245          | GRAPHITE  | SPR/RAD           | 75              | INT TH     | 344.9 | x | 271.0     | x | 5.6 | 13.58 | x | 10.67 | x | 0.222 |
| 9G5287                 | FM4157          | ELASTOMER | SPR/RAD/WAG       | 80              | INT TH     | 432.1 | x | 337.8     | x | 5.6 | 17.01 | x | 13.3  | x | 0.22  |
| ALTERNATIVE            | FM6283          | CARBON    | WAFFLE            | 80              | INT TH     | 432.1 | x | 337.8     | x | 5.6 | 17.01 | x | 13.3  | x | 0.22  |
| 9G5288                 | FM6131          | ELASTOMER | SPR/RAD/WAG       | 101             | INT TH     | 534.0 | x | 417.0     | x | 5.6 | 21.02 | x | 16.42 | x | 0.22  |
| ALTERNATIVE            | FM7547          | CARBON    | WAFFLE            | 101             | INT TH     | 534.0 | x | 417.0     | x | 5.6 | 21.02 | x | 16.42 | x | 0.22  |
| 9G7403                 | FM2387          | GRAPHITE  | SPR/RAD           | 65              | INT TH     | 283.3 | x | 204.2     | x | 5.0 | 11.15 | x | 8.04  | x | 0.197 |
| 9G7463                 | FM3040MP        | STEEL     | -----             | 6               | EXT LG     | 595.0 | x | 454.0     | x | 6.4 | 23.43 | x | 17.87 | x | 0.25  |
| 9G8542                 | FM2829          | PAPER     | 2 PASS            | 45              | INT TH     | 133.1 | x | 92.7      | x | 2.1 | 5.24  | x | 3.65  | x | 0.083 |
| 9G9883                 | FM2982MP        | STEEL     | -----             | 6               | EXT LG     | 584.2 | x | 453.4     | x | 6.4 | 23.0  | x | 17.85 | x | 0.25  |
| 1H8379                 | FM1641          | ORGANIC   | -----             |                 | LINING     | 137.2 | x | 31.8      | x | 4.7 | 5.4   | x | 1.25  | x | 0.185 |
| 2H6121                 | FM1635          | BRONZE    | SPR/WAG           | 64              | INT TH     | 355.6 | x | 200.2     | x | 7.1 | 14.0  | x | 7.88  | x | 0.28  |
| 2H6936                 | FM1542MP        | STEEL     | -----             | 8               | INT LG     | 289.1 | x | 194.1     | x | 2.3 | 11.38 | x | 7.64  | x | 0.09  |
| 3H2725                 | FM5386MP        | STEEL     | -----             | 72              | EXT TH     | 468.1 | x | 311.0     | x | 6.4 | 18.43 | x | 12.24 | x | 0.25  |
| 4H2922                 | FM1619          | BRONZE    | SPR/WAG           | 94              | INT TH     | 444.5 | x | 295.5     | x | 7.1 | 17.5  | x | 11.63 | x | 0.28  |
| 4H2923                 | FM1635          | BRONZE    | SPR/WAG           | 64              | INT TH     | 355.6 | x | 200.2     | x | 7.1 | 14.0  | x | 7.88  | x | 0.28  |
| 5H0047                 | FM1748MP        | STEEL     | -----             | 78              | EXT TH     | 400.1 | x | 241.3     | x | 6.4 | 15.75 | x | 9.5   | x | 0.25  |
| 5H0048                 | FM1745          | CORK      | SPIRAL            | 64              | INT TH     | 381.0 | x | 197.6     | x | 5.5 | 15.0  | x | 7.78  | x | 0.215 |
| 5H8530                 | FM1607          | BRONZE    | -----             | 119             | EXT TH     | 255.5 | x | 171.5     | x | 4.7 | 10.06 | x | 6.75  | x | 0.187 |
| 6H2839                 | FM1352MP        | STEEL     | -----             | 6               | EXT LG     | 577.9 | x | 452.1     | x | 6.4 | 22.75 | x | 17.8  | x | 0.25  |
| 7H2060                 | FM2378MP        | STEEL     | -----             | 8               | INT LG     | 393.7 | x | 273.8     | x | 2.4 | 15.5  | x | 10.78 | x | 0.094 |
| 7H2118                 | FM1609          | BRONZE    | SPR/WAG           | 128             | EXT TH     | 412.2 | x | 292.1     | x | 4.7 | 16.23 | x | 11.5  | x | 0.187 |
| 8H1331                 | FM1609          | BRONZE    | SPR/WAG           | 128             | EXT TH     | 412.2 | x | 292.1     | x | 4.7 | 16.23 | x | 11.5  | x | 0.187 |
| 9H9705                 | FM1625          | BRONZE    | SPR/RAD           | 138             | INT TH     | 533.4 | x | 435.1     | x | 5.6 | 21    | x | 17.13 | x | 0.22  |
| 9H9709                 | FM1420MP        | STEEL     | -----             | 8               | INT LG     | 368.3 | x | 273.1     | x | 2.3 | 14.5  | x | 10.75 | x | 0.09  |
| 5I8629                 | FM3796MP        | STEEL     | -----             | 12              | EXT LG     | 163.6 | x | 140.0     | x | 1.6 | 6.44  | x | 5.51  | x | 0.063 |
| 5I8630                 | FM3793          | PAPER     | 2 PASS            | 36              | (43)INT TH | 156.0 | x | 129.0     | x | 1.8 | 6.14  | x | 5.08  | x | 0.071 |
| 6I8028                 | FM2261          | PAPER     | 2 PASS            | 61              | INT TH     | 281.7 | x | 220.0     | x | 4.9 | 11.09 | x | 8.66  | x | 0.193 |
| 6I8029                 | FM2263          | PAPER     | 2 PASS            | 35              | INT TH     | 184.7 | x | 125.7     | x | 4.9 | 7.27  | x | 4.95  | x | 0.193 |
| 6I8030                 | FM6963          | CARBON PA | WAFFLE            | 18              | INT TH     | 422.0 | x | 88.0      | x | 9.1 | 16.61 | x | 3.46  | x | 0.358 |
| 6I8500                 | FM2248MP        | STEEL     | -----             | 5               | EXT LG     | 380.0 | x | 284.0     | x | 5.0 | 14.96 | x | 11.18 | x | 0.197 |
| 6I8597                 | FM7939          | CARBON PA | 3 PASS            | 101             | INT TH     | 533.2 | x | 418.3     | x | 5.6 | 20.99 | x | 16.47 | x | 0.22  |
| 6I8911                 | FM3205          | PAPER     | 2 PASS            | 52              | INT TH     | 216.0 | x | 128.0     | x | 4.0 | 8.5   | x | 5.04  | x | 0.157 |
| 6I8912                 | FM3199          | PAPER     | 2 PASS            | 52              | INT TH     | 190.0 | x | 128.0     | x | 4.0 | 7.48  | x | 5.04  | x | 0.157 |
| 6I8915                 | FM2655          | BRONZE    | SPR/WAG           | 142             | EXT TH     | 457.2 | x | 342.9     | x | 4.7 | 18.0  | x | 13.5  | x | 0.185 |
| 6I8916                 | FM1609          | BRONZE    | SPR/WAG           | 128             | EXT TH     | 412.2 | x | 292.1     | x | 4.7 | 16.23 | x | 11.5  | x | 0.187 |
| 6I9255                 | FM2387          | GRAPHITE  | SPR/RAD           | 65              | INT TH     | 283.3 | x | 204.2     | x | 5.0 | 11.15 | x | 8.04  | x | 0.197 |
| 6I9502                 | FM4118MP        | STEEL     | -----             | 42              | EXT TH     | 202.0 | x | 138.3     | x | 3.0 | 7.95  | x | 5.44  | x | 0.118 |
| 6I9509                 | FM4866MP        | STEEL     | -----             | 3               | INT LG     | 297.4 | x | 175.5     | x | 2.5 | 11.71 | x | 6.91  | x | 0.098 |
| 6I9510                 | FM8260MP        | STEEL     | -----             | 3               | INT LG     | 371.0 | x | 203.2     | x | 2.5 | 14.61 | x | 9.06  | x | 0.096 |

| REPLACES<br>OEM PT.NO. | FMC<br>PART NO. | MATERIAL  | GROOVE<br>DETAILS | TEETH/<br>TANGS | SIZE MM | SIZE INCH                                 |
|------------------------|-----------------|-----------|-------------------|-----------------|---------|---|
| 8I3880                 | FM2632MP        | STEEL     | -----             | 6               | EXT LG  | 199.0 x 130.0 x 2.6 7.83 x 5.12 x 0.102   |
| 8I3881                 | FM2647          | PAPER     | 2 PASS            | 19              | INT TH  | 178.0 x 34.0 x 4.8 7.01 x 1.34 x 0.189    |
| 8I4482                 | FM4036MP        | END PLATE | STEPPED           | 4               | EXT LG  | 129.0 x 74.0 x 5.0 5.08 x 2.91 x 0.197    |
| 8I4483                 | FM2719          | PAPER     | 2 PASS            | 33              | INT TH  | 117.9 x 68.1 x 2.2 4.65 x 2.68 x 0.087    |
| 8I4484                 | FM2718MP        | STEEL     | -----             | 4               | EXT LG  | 129.0 x 76.0 x 1.5 5.08 x 2.99 x 0.059    |
| 2J5262                 | FM1615          | OBSOLETE  | WAGON             | 136             | EXT TH  | 435.6 x 321.6 x 4.7 17.15 x 12.66 x 0.184 |
| 2J5513                 | FM1611          | BRONZE    | WAGON             | 120             | EXT TH  | 384.8 x 292.6 x 4.7 15.15 x 11.52 x 0.187 |
| 3J1151                 | FM0467          | OBSOLETE  | WAGON             | 122             | EXT TH  | 359.0 x 269.2 x 4.7 14.13 x 10.6 x 0.185  |
| 1K8953                 | FM2876MP        | STEEL     | -----             | 5               | EXT LG  | 326.4 x 233.0 x 6.4 12.85 x 8.78 x 0.25   |
| 2K5706                 | FM4889          | BRONZE    | SPR/RAD           | 66              | INT TH  | 285.6 x 204.5 x 5.0 11.24 x 8.05 x 0.197  |
| 3K1385                 | FM2874MP        | STEEL     | -----             | 5               | EXT LG  | 386.1 x 263.4 x 6.4 15.2 x 10.37 x 0.25   |
| 3K2299                 | FM2305          | BRONZE    | SPR/RAD           | 78              | INT TH  | 331.5 x 244.9 x 5.0 13.05 x 9.64 x 0.196  |
| 3K3825                 | FM2259          | BRONZE    | SPR/RAD           | 56              | INT TH  | 265.2 x 173.0 x 4.1 10.44 x 6.81 x 0.161  |
| 4K1317                 | FM1884MP        | STEEL     | -----             | 8               | INT LG  | 288.5 x 194.1 x 2.0 11.36 x 7.64 x 0.08   |
| 4K1333                 | FM1617          | BRONZE    | SPR/WAG           | 95              | EXT TH  | 304.8 x 212.9 x 4.3 12.0 x 8.38 x 0.168   |
| 4K4587                 | FM3913          | BRONZE    | SPR/RAD           | 122             | EXT TH  | 370.0 x 280.0 x 4.8 14.57 x 11.02 x 0.189 |
| 5K4587                 | FM4197          | BRONZE    | SPR/WAG           | 50              | INT TH  | 305.0 x 156.0 x 7.1 12.01 x 6.14 x 0.28   |
| 5K8616                 | FM1924MP        | STEEL     | -----             | 8               | INT LG  | 288.5 x 194.1 x 2.0 11.36 x 7.64 x 0.08   |
| 5K8617                 | FM1879          | PAPER     | 2 PASS            | 95              | EXT TH  | 304.8 x 212.9 x 3.5 12.0 x 8.38 x 0.138   |
| 6K6466                 | FM4197          | BRONZE    | SPR/WAG           | 50              | INT TH  | 305.0 x 156.0 x 7.1 12.01 x 6.14 x 0.28   |
| 8K0507                 | FM3085          | PAPER     | 2 PASS            | 24              | INT TH  | 177.6 x 73.3 x 5.2 6.99 x 2.88 x 0.205    |
| 8K0509                 | FM3080MP        | STEEL     | -----             | 44              | EXT TH  | 189.0 x 83.0 x 4.7 7.44 x 3.27 x 0.185    |
| 2L1752                 | FM1732MP        | STEEL     | -----             | 40              | INT TH  | 203.2 x 122.8 x 2.3 8.0 x 4.83 x 0.091    |
| 2L1753                 | FM2605          | BRONZE    | SPR/RAD           | 12              | EXT LG  | 236.0 x 139.7 x 3.1 9.29 x 5.5 x 0.122    |
| 3L8440                 | FM2605          | BRONZE    | SPR/RAD           | 12              | EXT LG  | 236.0 x 139.7 x 3.1 9.29 x 5.5 x 0.122    |
| 4L9785                 | FM1801          | BRONZE    | WAFFLE            | 76              | EXT TH  | 164.1 x 103.1 x 2.8 6.46 x 4.06 x 0.11    |
| 6L2179                 | FM1660MP        | STEEL     | -----             | 45              | INT TH  | 152.4 x 92.5 x 1.6 6.0 x 3.64 x 0.063     |
| 6L9719                 | FM4074MP        | STEEL     | -----             | 42              | INT TH  | 101.6 x 64.8 x 1.6 4.0 x 2.55 x 0.063     |
| 6L9720                 | FM3565          | BRONZE    | RADIAL            | 68              | EXT TH  | 112.3 x 71.3 x 2.1 4.42 x 2.81 x 0.083    |
| 7L5123                 | FM5123          | BRONZE    | WAFFLE            | 88              | EXT TH  | 189.5 x 117.6 x 3.1 7.46 x 4.63 x 0.122   |
| 7L7782                 | FM1801          | BRONZE    | WAFFLE            | 76              | EXT TH  | 164.1 x 103.1 x 2.8 6.46 x 4.06 x 0.11    |
| 9L2179                 | FM1660MP        | STEEL     | -----             | 45              | INT TH  | 152.4 x 92.5 x 1.5 6.0 x 3.64 x 0.06      |
| 2M2179                 | FM4744MP        | OBSOLETE  | -----             | 6               | EXT LG  | 407.9 x 247.0 x 6.4 16.06 x 9.72 x 0.25   |
| 2M8911                 | FM2655          | BRONZE    | SPR/WAG           | 142             | EXT TH  | 457.2 x 342.9 x 4.7 18.0 x 13.5 x 0.185   |
| 2M8912                 | FM1750MP        | STEEL     | -----             | 8               | INT LG  | 438.2 x 325.1 x 2.3 17.25 x 12.8 x 0.09   |
| 4M1625                 | FM2754MP        | STEEL     | -----             | 6               | EXT LG  | 529.6 x 407.5 x 6.7 20.85 x 16.04 x 0.265 |
| 4M5863                 | FM1627          | BRONZE    | SPR/RAD           | 142             | INT TH  | 533.4 x 445.8 x 5.6 21.0 x 17.55 x 0.22   |
| 4M7098                 | FM1623          | BRONZE    | SPR/RAD           | 108             | INT TH  | 431.8 x 337.8 x 5.6 17.0 x 13.3 x 0.22    |
| 4M7124                 | FM2831          | BRONZE    | SPR/RAD           | 124             | INT TH  | 482.6 x 388.6 x 5.6 19.0 x 15.3 x 0.219   |
| 4M8914                 | FM2864MP        | STEEL     | -----             | 5               | EXT LG  | 305.8 x 189.1 x 6.4 12.04 x 7.44 x 0.25   |
| 5M1199                 | FM1613          | BRONZE    | SPR/WAG           | 120             | EXT TH  | 384.0 x 291.3 x 4.7 15.12 x 11.47 x 0.185 |
| 5M2096                 | FM1354MP        | STEEL     | -----             | 6               | EXT LG  | 577.9 x 464.3 x 6.4 22.75 x 18.28 x 0.25  |
| 5M6122                 | FM1631          | BRONZE    | SPR/RAD           | 96              | INT TH  | 381.0 x 300.0 x 5.6 15.0 x 11.81 x 0.22   |
| 7M1385                 | FM1625          | BRONZE    | SPR/RAD           | 138             | INT TH  | 533.4 x 435.1 x 5.6 21.0 x 17.13 x 0.22   |
| 7M5713                 | FM1623          | BRONZE    | SPR/RAD           | 108             | INT TH  | 431.8 x 337.8 x 5.6 17.0 x 13.3 x 0.22    |
| 7M5745                 | FM1625          | BRONZE    | SPR/RAD           | 138             | INT TH  | 533.4 x 435.1 x 5.6 21.0 x 17.13 x 0.22   |
| 7M5760                 | FM1625          | BRONZE    | SPR/RAD           | 138             | INT TH  | 533.4 x 435.1 x 5.6 21.0 x 17.13 x 0.22   |
| 7M5781                 | FM3663          | BRONZE    | SPR/RAD           | 65              | INT TH  | 286.0 x 204.0 x 4.9 11.26 x 8.03 x 0.193  |



| REPLACES<br>OEM PT.NO. | FMC<br>PART NO. | MATERIAL             | GROOVE<br>DETAILS | TEETH/<br>TANGS | SIZE MM    |       |   | SIZE INCH |   |     |       |   |       |   |       |
|------------------------|-----------------|----------------------|-------------------|-----------------|------------|-------|---|-----------|---|-----|-------|---|-------|---|-------|
| 8M2476                 | FM2259          | BRONZE               | SPR/RAD           | 56              | INT TH     | 265.2 | x | 173.0     | x | 4.1 | 10.44 | x | 6.81  | x | 0.161 |
| 8M5046                 | FM1623          | BRONZE               | SPR/RAD           | 108             | INT TH     | 431.8 | x | 337.8     | x | 5.6 | 17.0  | x | 13.3  | x | 0.22  |
| 8M5047                 | FM1625          | BRONZE               | SPR/RAD           | 138             | INT TH     | 533.4 | x | 435.1     | x | 5.6 | 21.0  | x | 17.13 | x | 0.22  |
| 8M5070                 | FM1627          | BRONZE               | SPR/RAD           | 142             | INT TH     | 533.4 | x | 445.8     | x | 5.6 | 21.0  | x | 17.55 | x | 0.22  |
| 8M5136                 | FM1751          | BRONZE               | SPR/RAD           | 56              | INT TH     | 265.2 | x | 173.0     | x | 4.6 | 10.44 | x | 6.81  | x | 0.18  |
| 8M6357                 | FM2259          | BRONZE               | SPR/RAD           | 56              | INT TH     | 265.2 | x | 173.0     | x | 4.1 | 10.44 | x | 6.81  | x | 0.161 |
| 8M6358                 | FM1623          | BRONZE               | SPR/RAD           | 108             | INT TH     | 431.8 | x | 337.8     | x | 5.6 | 17.0  | x | 13.3  | x | 0.22  |
| 8M6458                 | FM1623          | BRONZE               | SPR/RAD           | 108             | INT TH     | 431.8 | x | 337.8     | x | 5.6 | 17.0  | x | 13.3  | x | 0.22  |
| 8M8550                 | FM1623          | BRONZE               | SPR/RAD           | 108             | INT TH     | 431.8 | x | 337.8     | x | 5.6 | 17.0  | x | 13.3  | x | 0.22  |
| 8M8610                 | FM1446MP        | STEEL                | -----             | 6               | EXT LG     | 477.0 | x | 355.6     | x | 6.7 | 18.78 | x | 14.0  | x | 0.265 |
| 8M8651                 | FM1908MP        | STEEL                | -----             | 5               | EXT LG     | 411.5 | x | 317.5     | x | 6.4 | 16.2  | x | 12.5  | x | 0.25  |
| 9M2176                 | FM3663          | BRONZE               | SPR/RAD           | 65              | INT TH     | 286.0 | x | 204.0     | x | 4.9 | 11.26 | x | 8.03  | x | 0.193 |
| 9M7471                 | FM1890MP        | STEEL                | -----             | 72              | EXT TH     | 369.8 | x | 222.3     | x | 6.4 | 14.56 | x | 8.75  | x | 0.25  |
| 2N2428                 | FM3565          | BRONZE               | RADIAL            | 68              | EXT TH     | 112.3 | x | 71.3      | x | 2.1 | 4.42  | x | 2.81  | x | 0.083 |
| 5N6137                 | FM2638MP        | STEEL                | -----             | 40              | INT TH     | 203.2 | x | 122.9     | x | 4.7 | 8.0   | x | 4.84  | x | 0.185 |
| 5N1884                 | FM1732MP        | STEEL                | -----             | 40              | INT TH     | 203.2 | x | 122.8     | x | 2.3 | 8.0   | x | 4.83  | x | 0.091 |
| 9N4325                 | FM4469          | OBSOLETE AFTER STOCK |                   | 51              | (55)INT TH | 267.0 | x | 172.0     | x | 4.6 | 10.51 | x | 6.77  | x | 0.181 |
| 9N4331                 | FM3040MP        | STEEL                | -----             | 6               | EXT LG     | 595.0 | x | 454.0     | x | 6.4 | 23.43 | x | 17.87 | x | 0.25  |
| 9N4332                 | FM2982MP        | STEEL                | -----             | 6               | EXT LG     | 584.2 | x | 453.4     | x | 6.4 | 23.0  | x | 17.85 | x | 0.25  |
| 9N4333                 | FM2754MP        | STEEL                | -----             | 6               | EXT LG     | 529.6 | x | 407.5     | x | 6.7 | 20.85 | x | 16.04 | x | 0.265 |
| 9N4617                 | FM2881          | PAPER                | 3 PASS            | 58              | INT TH     | 266.2 | x | 181.6     | x | 4.8 | 10.48 | x | 7.15  | x | 0.19  |
| 1P4110                 | FM1631          | BRONZE               | SPR/RAD           | 96              | INT TH     | 381.0 | x | 300.0     | x | 5.6 | 15.0  | x | 11.81 | x | 0.22  |
| 1P6996                 | FM1609          | BRONZE               | SPR/WAG           | 128             | EXT TH     | 412.2 | x | 292.1     | x | 4.7 | 16.23 | x | 11.5  | x | 0.187 |
| 1P9256                 | FM2206MP        | STEEL                | -----             | 70              | EXT TH     | 224.5 | x | 177.8     | x | 3.0 | 8.84  | x | 7.0   | x | 0.12  |
| 2P2903                 | FM1530MP        | STEEL                | -----             | 5               | EXT LG     | 306.3 | x | 213.4     | x | 6.4 | 12.06 | x | 8.4   | x | 0.25  |
| 2P3719                 | FM1825          | PAPER                | 2 PASS            | 54              | INT TH     | 215.0 | x | 168.4     | x | 2.9 | 8.46  | x | 6.63  | x | 0.116 |
| 2P3747                 | FM2415          | PAPER                | 2 PASS            | 24              | INT TH     | 120.4 | x | 73.4      | x | 3.0 | 4.74  | x | 2.89  | x | 0.118 |
| 2P4370                 | FM1488MP        | STEEL                | -----             | 56              | INT TH     | 268.0 | x | 173.5     | x | 3.2 | 10.55 | x | 6.83  | x | 0.126 |
| 2P4371                 | FM1449          | PAPER                | 2 PASS            | 75              | EXT TH     | 277.6 | x | 189.0     | x | 3.3 | 10.93 | x | 7.44  | x | 0.129 |
| 2P4472                 | FM1908MP        | STEEL                | -----             | 5               | EXT LG     | 411.5 | x | 317.5     | x | 6.4 | 16.2  | x | 12.5  | x | 0.25  |
| 2P5698                 | FM8260MP        | STEEL                | -----             | 3               | INT LG     | 371.0 | x | 203.2     | x | 2.5 | 14.61 | x | 9.06  | x | 0.096 |
| 2P5725                 | FM4866MP        | STEEL                | -----             | 3               | INT LG     | 297.4 | x | 175.5     | x | 2.5 | 11.71 | x | 6.91  | x | 0.098 |
| 2P9314                 | FM3077          | CARBON PA            | SPR/RAD           | 12              | EXT LG     | 361.9 | x | 241.6     | x | 6.2 | 14.25 | x | 9.51  | x | 0.242 |
| 2P9336                 | FM3871          | PAPER                | SPR/RAD           | 12              | EXT LG     | 420.0 | x | 254.0     | x | 6.3 | 16.54 | x | 10.0  | x | 0.248 |
| 2P9343                 | FM1449          | PAPER                | 2 PASS            | 75              | EXT TH     | 277.6 | x | 189.0     | x | 3.3 | 10.93 | x | 7.44  | x | 0.129 |
| 3P0337                 | FM1898MP        | STEEL                | -----             | 24              | INT TH     | 215.9 | x | 155.7     | x | 2.8 | 8.5   | x | 6.13  | x | 0.11  |
| 3P0340                 | FM2113          | PAPER                | 2 PASS            | 32              | EXT TH     | 224.8 | x | 165.1     | x | 4.3 | 8.85  | x | 6.5   | x | 0.17  |
| 3P0392                 | FM2643          | PAPER                | 2 PASS            | 40              | EXT TH     | 280.4 | x | 200.0     | x | 4.3 | 11.04 | x | 7.87  | x | 0.169 |
| 3P0801                 | FM1534MP        | STEEL                | -----             | 32              | EXT LG     | 224.8 | x | 177.8     | x | 4.8 | 8.85  | x | 7.0   | x | 0.189 |
| 3P0805                 | FM1825          | PAPER                | 2 PASS            | 54              | INT TH     | 215.0 | x | 168.4     | x | 2.9 | 8.46  | x | 6.63  | x | 0.116 |
| 3P0818                 | FM3042MP        | STEEL                | -----             | 81              | EXT TH     | 296.5 | x | 222.0     | x | 4.7 | 11.67 | x | 8.74  | x | 0.185 |
| 3P0819                 | FM3044MP        | STEEL                | -----             | 81              | EXT TH     | 296.5 | x | 222.0     | x | 9.5 | 11.67 | x | 8.74  | x | 0.374 |
| 3P1686                 | FM1352MP        | STEEL                | -----             | 6               | EXT LG     | 577.9 | x | 452.1     | x | 6.4 | 22.75 | x | 17.8  | x | 0.25  |
| 3P1687                 | FM1354MP        | STEEL                | -----             | 6               | EXT LG     | 577.9 | x | 464.3     | x | 6.4 | 22.75 | x | 18.28 | x | 0.25  |
| 3P2346                 | FM1446MP        | STEEL                | -----             | 6               | EXT LG     | 477.0 | x | 355.6     | x | 6.7 | 18.78 | x | 14.0  | x | 0.265 |
| 3P2855                 | FM2646MP        | STEEL                | -----             | 28              | INT TH     | 268.2 | x | 191.1     | x | 2.8 | 10.56 | x | 7.52  | x | 0.11  |
| 3P3241                 | FM1890MP        | STEEL                | -----             | 72              | EXT TH     | 369.8 | x | 222.3     | x | 6.4 | 14.56 | x | 8.75  | x | 0.25  |

| REPLACES<br>OEM PT.NO. | FMC<br>PART NO. | MATERIAL  | GROOVE<br>DETAILS | TEETH/<br>TANGS | SIZE MM | SIZE INCH                                 |
|------------------------|-----------------|-----------|-------------------|-----------------|---------|---|
| 3P3561                 | FM1633          | BRONZE    | SPR/WAG           | 96              | INT TH  | 381.0 x 300.0 x 5.6 15.0 x 11.81 x 0.22   |
| 3P4057                 | FM2754MP        | STEEL     | -----             | 6               | EXT LG  | 529.6 x 407.5 x 6.7 20.85 x 16.04 x 0.265 |
| 3P5431                 | FM2387          | GRAPHITE  | SPR/RAD           | 65              | INT TH  | 283.3 x 204.2 x 5.0 11.15 x 8.04 x 0.197  |
| 3P5955                 | FM1639          | BRONZE    | SPR/RAD           | 101             | INT TH  | 311.2 x 252.5 x 5.0 12.25 x 9.94 x 0.195  |
| 3P6076                 | FM6131          | ELASTOMER | SPR/RAD/WAG       | 101             | INT TH  | 534.0 x 417.0 x 5.6 21.02 x 16.42 x 0.22  |
| ALTERNATIVE            | FM7547          | CARBON    | WAFFLE            | 101             | INT TH  | 534.0 x 417.0 x 5.6 21.02 x 16.42 x 0.22  |
| 3P6077                 | FM6131          | ELASTOMER | SPR/RAD/WAG       | 101             | INT TH  | 534.0 x 417.0 x 5.6 21.02 x 16.42 x 0.22  |
| ALTERNATIVE            | FM7547          | CARBON    | WAFFLE            | 101             | INT TH  | 534.0 x 417.0 x 5.6 21.02 x 16.42 x 0.22  |
| 3P6183                 | FM4157          | ELASTOMER | SPR/RAD/WAG       | 80              | INT TH  | 432.1 x 337.8 x 5.6 17.01 x 13.3 x 0.22   |
| ALTERNATIVE            | FM6283          | CARBON    | WAFFLE            | 80              | INT TH  | 432.1 x 337.8 x 5.6 17.01 x 13.3 x 0.22   |
| 3P7447                 | FM1446MP        | STEEL     | -----             | 6               | EXT LG  | 477.0 x 355.6 x 6.7 18.78 x 14.0 x 0.265  |
| 3P7489                 | FM2426MP        | STEEL     | -----             | 40              | EXT TH  | 297.9 x 223.3 x 3.2 11.73 x 8.79 x 0.125  |
| 3P7584                 | FM2810MP        | STEEL     | -----             | 6               | EXT LG  | 584.2 x 438.7 x 6.4 23.0 x 17.27 x 0.25   |
| 3P8160                 | FM2772MP        | STEEL     | -----             | 39              | EXT TH  | 273.0 x 213.4 x 4.7 10.75 x 8.4 x 0.185   |
| 3P8393                 | FM1530MP        | STEEL     | -----             | 5               | EXT LG  | 306.3 x 213.4 x 6.4 12.06 x 8.4 x 0.25    |
| 3P9403                 | FM1599          | BRONZE    | SPR/RAD           | 81              | INT TH  | 264.9 x 201.8 x 4.6 10.43 x 7.95 x 0.183  |
| 3P9405                 | FM1530MP        | STEEL     | -----             | 5               | EXT LG  | 306.3 x 213.4 x 6.4 12.06 x 8.4 x 0.25    |
| 6P3089                 | FM2255          | PAPER     | 2 PASS            | 36              | INT TH  | 144.0 x 87.9 x 3.0 5.67 x 3.46 x 0.118    |
| 6P5404                 | FM2312MP        | STEEL     | -----             | 128             | EXT LG  | 410.0 x 292.1 x 2.3 16.14 x 11.5 x 0.09   |
| 6P5615                 | FM1352MP        | STEEL     | -----             | 6               | EXT LG  | 577.9 x 452.1 x 6.4 22.75 x 17.8 x 0.25   |
| 6P7968                 | FM2170MP        | STEEL     | -----             | 28              | EXT TH  | 196.9 x 138.9 x 3.2 7.75 x 5.47 x 0.125   |
| 7P3106                 | FM3831          | PAPER     | 2 PASS            | 56              | EXT TH  | 239.0 x 157.0 x 4.0 9.41 x 6.18 x 0.157   |
| 7P4673                 | FM3506MP        | STEEL     | -----             | 50              | INT TH  | 229.0 x 77.0 x 2.3 9.02 x 3.03 x 0.091    |
| 8P1656                 | FM1532MP        | STEEL     | -----             | 5               | EXT LG  | 353.1 x 263.1 x 6.4 13.9 x 10.36 x 0.25   |
| 8P1964                 | FM2252MP        | STEEL     | -----             | 36              | EXT TH  | 252.2 x 186.2 x 4.0 9.93 x 7.33 x 0.157   |
| 8P2051                 | FM2248MP        | STEEL     | -----             | 5               | EXT LG  | 380.0 x 284.0 x 5.0 14.96 x 11.18 x 0.197 |
| 8P4316                 | FM2393          | BRONZE    | SUNBURST          | 88              | INT TH  | 393.7 x 273.3 x 4.7 15.5 x 10.76 x 0.185  |
| 8P4736                 | FM1629          | BRONZE    | SPR/WAG           | 138             | INT TH  | 533.4 x 435.1 x 5.6 21.0 x 17.13 x 0.22   |
| 8P5646                 | FM1637          | BRONZE    | SPR/WAG           | 108             | INT TH  | 431.8 x 337.8 x 5.6 17.0 x 13.3 x 0.22    |
| 8P5687                 | FM2854MP        | STEEL     | -----             | 6               | EXT LG  | 482.0 x 355.6 x 6.7 19.0 x 14.0 x 0.265   |
| 8P8360                 | FM6651          | PAPER     | SUNBURST          | 88              | INT TH  | 393.7 x 273.3 x 4.7 15.5 x 10.76 x 0.185  |
| 8P8679                 | FM1513          | PAPER     | 2 PASS            | 96              | INT TH  | 381.0 x 300.0 x 5.6 15.0 x 11.81 x 0.22   |
| 8P8680                 | FM1967          | PAPER     | 2 PASS            | 101             | INT TH  | 311.2 x 253.0 x 5.1 12.25 x 9.96 x 0.2    |
| 8P8681                 | FM1451          | PAPER     | 2 PASS            | 87              | EXT TH  | 277.9 x 209.6 x 5.0 10.94 x 8.25 x 0.196  |
| 8P8682                 | FM1825          | PAPER     | 2 PASS            | 54              | INT TH  | 215.0 x 168.4 x 2.9 8.46 x 6.63 x 0.116   |
| 8P8683                 | FM2303          | PAPER     | RAD/WAG           | 81              | INT TH  | 264.9 x 201.8 x 4.6 10.43 x 7.95 x 0.183  |
| 8P8921                 | FM2876MP        | STEEL     | -----             | 5               | EXT LG  | 326.4 x 233.0 x 6.4 12.85 x 8.78 x 0.25   |
| 8P9293                 | FM2263          | PAPER     | 2 PASS            | 35              | INT TH  | 184.7 x 125.7 x 4.9 7.27 x 4.95 x 0.193   |
| 8P9294                 | FM2261          | PAPER     | 2 PASS            | 61              | INT TH  | 281.7 x 220.0 x 4.9 11.09 x 8.66 x 0.193  |
| 8P9558                 | FM5141          | PAPER     | SUNBURST          | 104             | INT TH  | 440.0 x 326.0 x 4.8 17.32 x 12.83 x 0.189 |
| 8P9559                 | FM4809          | BRONZE    | SUNBURST          | 104             | INT TH  | 440.0 x 326.0 x 4.7 17.32 x 12.83 x 0.185 |
| 9P1861                 | FM2249          | PAPER     | 2 PASS            | 48              | INT TH  | 240.0 x 172.7 x 5.1 9.45 x 6.8 x 0.2      |
| 9P3242                 | FM2940MP        | STEEL     | -----             | 4               | EXT LG  | 284.0 x 146.0 x 3.2 11.18 x 5.75 x 0.126  |
| 9P3664                 | FM6131          | ELASTOMER | SPR/RAD/WAG       | 101             | INT TH  | 534.0 x 417.0 x 5.6 21.02 x 16.42 x 0.22  |
| ALTERNATIVE            | FM7547          | CARBON    | WAFFLE            | 101             | INT TH  | 534.0 x 417.0 x 5.6 21.02 x 16.42 x 0.22  |
| 9P3665                 | FM4157          | ELASTOMER | SPR/RAD/WAG       | 80              | INT TH  | 432.1 x 337.8 x 5.6 17.01 x 13.3 x 0.22   |
| ALTERNATIVE            | FM6283          | CARBON    | WAFFLE            | 80              | INT TH  | 432.1 x 337.8 x 5.6 17.01 x 13.3 x 0.22   |
| 9P3667                 | FM4157          | ELASTOMER | SPR/RAD/WAG       | 80              | INT TH  | 432.1 x 337.8 x 5.6 17.01 x 13.3 x 0.22   |

| REPLACES<br>OEM PT.NO. | FMC<br>PART NO. | MATERIAL   | GROOVE<br>DETAILS | TEETH/<br>TANGS | SIZE MM    | SIZE INCH                                 |
|------------------------|-----------------|------------|-------------------|-----------------|------------|---|
| ALTERNATIVE            | FM6283          | CARBON     | WAFFLE            | 80              | INT TH     | 432.1 x 337.8 x 5.6 17.01 x 13.3 x 0.22   |
| 9P4251                 | FM1633          | BRONZE     | SPR/WAG           | 96              | INT TH     | 381.0 x 300.0 x 5.6 15.0 x 11.81 x 0.22   |
| 9P4253                 | FM4083          | BRONZE     | SPR/WAG           | 62              | INT TH     | 311.2 x 192.5 x 5.0 12.25 x 7.58 x 0.197  |
| 9P4254                 | FM2765          | BRONZE     | SPR/WAG           | 65              | INT TH     | 286.0 x 204.0 x 4.9 11.26 x 8.03 x 0.193  |
| 9P4878                 | FM2305          | BRONZE     | SPR/RAD           | 78              | INT TH     | 331.5 x 244.9 x 5.0 13.05 x 9.64 x 0.196  |
| 9P5083                 | FM6131          | ELASTOMER  | SPR/RAD/WAG       | 101             | INT TH     | 534.0 x 417.0 x 5.6 21.02 x 16.42 x 0.22  |
| ALTERNATIVE            | FM7547          | CARBON     | WAFFLE            | 101             | INT TH     | 534.0 x 417.0 x 5.6 21.02 x 16.42 x 0.22  |
| 9P5084                 | FM6131          | ELASTOMER  | SPR/RAD/WAG       | 101             | INT TH     | 534.0 x 417.0 x 5.6 21.02 x 16.42 x 0.22  |
| ALTERNATIVE            | FM7547          | CARBON     | WAFFLE            | 101             | INT TH     | 534.0 x 417.0 x 5.6 21.02 x 16.42 x 0.22  |
| 9P5254                 | FM1631          | BRONZE     | SPR/RAD           | 96              | INT TH     | 381.0 x 300.0 x 5.6 15.0 x 11.81 x 0.22   |
| 9P5499                 | FM4157          | ELASTOMER  | SPR/RAD/WAG       | 80              | INT TH     | 432.1 x 337.8 x 5.6 17.01 x 13.3 x 0.22   |
| ALTERNATIVE            | FM6283          | CARBON     | WAFFLE            | 80              | INT TH     | 432.1 x 337.8 x 5.6 17.01 x 13.3 x 0.22   |
| 9P5500                 | FM4157          | ELASTOMER  | SPR/RAD/WAG       | 80              | INT TH     | 432.1 x 337.8 x 5.6 17.01 x 13.3 x 0.22   |
| ALTERNATIVE            | FM6283          | CARBON     | WAFFLE            | 80              | INT TH     | 432.1 x 337.8 x 5.6 17.01 x 13.3 x 0.22   |
| 9P6082                 | FM2387          | GRAPHITE   | SPR/RAD           | 65              | INT TH     | 283.3 x 204.2 x 5.0 11.15 x 8.04 x 0.197  |
| 9P6903                 | FM2258MP        | STEEL      | -----             | 22              | EXT TH     | 155.0 x 98.8 x 2.0 6.1 x 3.89 x 0.078     |
| 9P7101                 | FM2254MP        | STEEL      | -----             | 6               | EXT LG     | 265.9 x 178.1 x 3.2 10.47 x 7.01 x 0.125  |
| 9P7390                 | FM3921          | ELASTOMER  | SPR/RAD           | 75              | INT TH     | 344.9 x 271.0 x 5.6 13.58 x 10.67 x 0.222 |
| ALTERNATIVE            | FM6887          | CARBON     | WAFFLE            | 75              | INT TH     | 344.9 x 271.0 x 5.6 13.58 x 10.67 x 0.222 |
| 9P9382                 | FM2409          | PAPER      | SUNBURST          | 120             | EXT TH     | 384.6 x 291.3 x 4.6 15.14 x 11.47 x 0.18  |
| 4Q1246                 | FM4449          | MOLYBDENUM | SPR/WAG           | 26              | INT TH     | 147.8 x 75.4 x 3.0 5.82 x 2.97 x 0.118    |
| 8Q2445                 | FM2647          | PAPER      | 2 PASS            | 19              | IN TH      | 178.0 x 34.0 x 4.8 7.01 x 1.34 x 0.189    |
| 8R6941                 | FM4142MP        | STEEL      | -----             | 189             | (203)EX TH | 1038.4 x 810.3 x 4.1 40.88 x 31.9 x 0.161 |
| 8R8733                 | FM4536-3.9      | STEEL      | HARDENED          | 4               | EXT LG     | 211.2 x 102.3 x 3.9 8.31 x 4.03 x 0.154   |
| 8R8734                 | FM4536-4.0      | STEEL      | HARDENED          | 4               | EXT LG     | 211.2 x 102.3 x 4.0 8.31 x 4.03 x 0.157   |
| 8R8735                 | FM4536MP        | STEEL      | HARDENED          | 4               | EXT LG     | 211.2 x 102.3 x 4.1 8.31 x 4.03 x 0.161   |
| 8R8736                 | FM4533          | MOLYBDENUM | SPR/RAD           | 44              | INT TH     | 191.3 x 94.2 x 4.1 7.53 x 3.71 x 0.161    |
| 8R9300                 | FM5250-3.0      | STEEL      | HARDENED          | 4               | EXT LG     | 189.8 x 92.1 x 3.0 7.47 x 3.63 x 0.118    |
| 8R9301                 | FM5250-2.9      | STEEL      | HARDENED          | 4               | EXT LG     | 189.8 x 92.1 x 2.9 7.47 x 3.63 x 0.114    |
| 8R9302                 | FM5252MP        | STEEL      | HARDENED          | 4               | EXT LG     | 190.0 x 92.3 x 3.1 7.48 x 3.63 x 0.122    |
| 8R9303                 | FM5247          | MOLYBDENUM | SPR/WAG           | 40              | INT TH     | 172.0 x 84.1 x 3.0 6.77 x 3.31 x 0.118    |
| 9R2476                 | FM1202MP        | STEEL      | -----             | 1               | EXT LG     | 209.3 x 114.3 x 2.7 8.24 x 4.5 x 0.106    |
| 9R2477                 | FM2987          | BRONZE     | SPR/WAG           | 22              | INT TH     | 204.5 x 53.3 x 4.8 8.05 x 2.1 x 0.19      |
| 9R9401                 | FM2640MP        | STEEL      | -----             | 1               | EXT SL     | 209.2 x 124.0 x 4.5 8.24 x 4.88 x 0.177   |
| 1S0057                 | FM2652MP        | STEEL      | -----             | 6               | EXT LG     | 343.0 x 210.0 x 6.4 13.5 x 8.27 x 0.25    |
| 1S1361                 | FM4712MP        | STEEL      | -----             | 8               | INT LG     | 368.3 x 273.0 x 3.6 14.5 x 10.75 x 0.142  |
| 1S3736                 | FM2831          | BRONZE     | SPR/RAD           | 124             | INT TH     | 482.6 x 388.6 x 5.6 19.0 x 15.3 x 0.219   |
| 1S3739                 | FM1631          | BRONZE     | SPR/RAD           | 96              | INT TH     | 381.0 x 300.0 x 5.6 15.0 x 11.81 x 0.22   |
| 1S8183                 | FM1635          | BRONZE     | SPR/WAG           | 64              | INT TH     | 355.6 x 200.2 x 7.1 14.0 x 7.88 x 0.28    |
| 1S8184                 | FM1619          | BRONZE     | SPR/WAG           | 94              | INT TH     | 444.5 x 295.5 x 7.1 17.5 x 11.63 x 0.28   |
| 1S8491                 | FM4083          | BRONZE     | SPR/WAG           | 62              | INT TH     | 311.2 x 192.5 x 5.0 12.25 x 7.58 x 0.197  |
| 2S1456                 | FM4889          | BRONZE     | SPR/RAD           | 66              | INT TH     | 285.6 x 204.5 x 5.0 11.24 x 8.05 x 0.197  |
| 2S4983                 | FM1451          | PAPER      | 2 PASS            | 87              | EXT TH     | 277.9 x 209.6 x 5.0 10.94 x 8.25 x 0.196  |
| 2S4983                 | FM3665          | BRONZE     | SPR/RAD           | 87              | EXT TH     | 277.6 x 209.5 x 5.0 10.94 x 8.25 x 0.196  |
| 2S5735                 | FM2868MP        | STEEL      | -----             | 6               | EXT LG     | 485.9 x 355.6 x 6.7 19.13 x 14 x 0.265    |
| 2S5736                 | FM2854MP        | STEEL      | -----             | 6               | EXT LG     | 482.0 x 355.6 x 6.7 19.0 x 14.0 x 0.265   |
| 2S9018                 | FM2878MP        | STEEL      | -----             | 5               | EXT LG     | 369.8 x 263.1 x 6.4 14.56 x 10.36 x 0.25  |

| REPLACES<br>OEM PT.NO. | FMC<br>PART NO. | MATERIAL | GROOVE<br>DETAILS | TEETH/<br>TANGS | SIZE MM   | SIZE INCH                                 |
|------------------------|-----------------|----------|-------------------|-----------------|-----------|---|
| 3S0040                 | FM2886MP        | STEEL    | -----             | 5               | EXT LG    | 432.2 x 316.2 x 6.4 17.02 x 12.45 x 0.25  |
| 3S0044                 | FM2770MP        | STEEL    | -----             | 5               | EXT LG    | 342.2 x 223.0 x 6.4 13.47 x 8.78 x 0.25   |
| 3S1168                 | FM1532MP        | STEEL    | -----             | 5               | EXT LG    | 353.1 x 263.1 x 6.4 13.9 x 10.36 x 0.25   |
| 3S1188                 | FM1639          | BRONZE   | SPR/RAD           | 101             | INT TH    | 311.2 x 252.5 x 5.0 12.25 x 9.94 x 0.195  |
| 3S1691                 | FM1420MP        | STEEL    | -----             | 8               | INT LG    | 368.3 x 273.1 x 2.3 14.5 x 10.75 x 0.09   |
| 3S7978                 | FM1530MP        | STEEL    | -----             | 5               | EXT LG    | 306.3 x 213.4 x 6.4 12.06 x 8.4 x 0.25    |
| 3S7981                 | FM1599          | BRONZE   | SPR/RAD           | 81              | INT TH    | 264.9 x 201.8 x 4.6 10.43 x 7.95 x 0.183  |
| 4S5891                 | FM1972MP        | STEEL    | -----             | 64              | INT TH    | 268.2 x 199.6 x 2.8 10.56 x 7.86 x 0.11   |
| 4S8694                 | FM2765          | BRONZE   | SPR/WAG           | 65              | INT TH    | 286.0 x 204.0 x 4.9 11.26 x 8.03 x 0.193  |
| 4S8695                 | FM1633          | BRONZE   | SPR/WAG           | 96              | INT TH    | 381.0 x 300.0 x 5.6 15.0 x 11.81 x 0.22   |
| 4S8724                 | FM2765          | BRONZE   | SPR/WAG           | 65              | INT TH    | 286.0 x 204.0 x 4.9 11.26 x 8.03 x 0.193  |
| 4S9072                 | FM1635          | BRONZE   | SPR/WAG           | 64              | INT TH    | 355.6 x 200.2 x 7.1 14.0 x 7.88 x 0.28    |
| 4S9073                 | FM1619          | BRONZE   | SPR/WAG           | 94              | INT TH    | 444.5 x 295.5 x 7.1 17.5 x 11.63 x 0.28   |
| 4S9074                 | FM1635          | BRONZE   | SPR/WAG           | 64              | INT TH    | 355.6 x 200.2 x 7.1 14.0 x 7.88 x 0.28    |
| 4S9075                 | FM1619          | BRONZE   | SPR/WAG           | 94              | INT TH    | 444.5 x 295.5 x 7.1 17.5 x 11.63 x 0.28   |
| 5S0071                 | FM1613          | BRONZE   | SPR/WAG           | 120             | EXT TH    | 384.0 x 291.3 x 4.7 15.12 x 11.47 x 0.185 |
| 5S7830                 | FM1625          | BRONZE   | SPR/RAD           | 138             | INT TH    | 533.4 x 435.1 x 5.6 21.0 x 17.13 x 0.22   |
| 6S3183                 | FM2701          | ORGANIC  | -----             | 71              | EXT TH    | 303.5 x 213.0 x 4.9 11.95 x 8.38 x 0.193  |
| 7S3992                 | FM1785          | IRON     | RADIAL            | 62              | INT TH    | 311.2 x 192.9 x 5.0 12.25 x 7.59 x 0.197  |
| 8S2174                 | FM2655          | BRONZE   | SPR/WAG           | 142             | EXT TH    | 457.2 x 342.9 x 4.7 18.0 x 13.5 x 0.185   |
| 8S3522                 | FM1532MP        | STEEL    | -----             | 5               | EXT LG    | 353.1 x 263.1 x 6.4 13.9 x 10.36 x 0.25   |
| 8S6324                 | FM2305          | BRONZE   | SPR/RAD           | 78              | INT TH    | 331.5 x 244.9 x 5.0 13.05 x 9.64 x 0.196  |
| 8S6325                 | FM2305          | BRONZE   | SPR/RAD           | 78              | INT TH    | 331.5 x 244.9 x 5.0 13.05 x 9.64 x 0.196  |
| 8S6326                 | FM1637          | BRONZE   | SPR/WAG           | 108             | INT TH    | 431.8 x 337.8 x 5.6 17.0 x 13.3 x 0.22    |
| 8S9000                 | FM4083          | BRONZE   | SPR/WAG           | 62              | INT TH    | 311.2 x 192.5 x 5.0 12.25 x 7.58 x 0.197  |
| 8S9077                 | FM1637          | BRONZE   | SPR/WAG           | 108             | INT TH    | 431.8 x 337.8 x 5.6 17.0 x 13.3 x 0.22    |
| 9S5209                 | FM2418MP        | STEEL    | -----             | 40              | EXT TH    | 128.8 x 83.1 x 3.2 5.07 x 3.27 x 0.125    |
| 9S5211                 | FM2412MP        | STEEL    | -----             | 6               | EXT LG    | 23.05 x 178.3 x 3.2 9.25 x 7.02 x 0.125   |
| 9S5244                 | FM1446MP        | STEEL    | -----             | 6               | EXT LG    | 477.0 x 355.6 x 6.7 18.78 x 14.0 x 0.265  |
| 9S5261                 | FM2414MP        | STEEL    | -----             | 6               | EXT LG    | 254.0 x 178.3 x 3.2 10.0 x 7.02 x 0.125   |
| 9S8789                 | FM1908MP        | STEEL    | -----             | 5               | EXT LG    | 411.5 x 317.5 x 6.4 16.2 x 12.5 x 0.25    |
| 9S8792                 | FM1530MP        | STEEL    | -----             | 5               | EXT LG    | 306.3 x 213.4 x 6.4 12.06 x 8.4 x 0.25    |
| 9S9922                 | FM2874MP        | STEEL    | -----             | 5               | EXT LG    | 386.1 x 263.4 x 6.4 15.2 x 10.37 x 0.25   |
| 9S9923                 | FM1623          | BRONZE   | SPR/RAD           | 108             | INT TH    | 431.8 x 337.8 x 5.6 17.0 x 13.3 x 0.22    |
| 1T0886                 | FM3462MP        | STEEL    | -----             | 141             | EXT TH    | 362.0 x 254.0 x 3.5 14.25 x 10.0 x 0.136  |
| 1T0887                 | FM3303          | BRONZE   | 3 PASS            | 96              | INT TH    | 347.7 x 240.0 x 4.9 13.69 x 9.45 x 0.191  |
| 1T1239                 | FM3438MP        | STEEL    | -----             | 166             | EXT TH    | 426.6 x 299.0 x 3.4 16.8 x 11.77 x 0.134  |
| 1T1240                 | FM4075          | BRONZE   | 4 PASS            | 114             | INT TH    | 412.0 x 285.0 x 4.9 16.22 x 11.22 x 0.193 |
| 1T1315                 | FM3462MP        | STEEL    | -----             | 141             | EXT TH    | 362.0 x 254.0 x 3.5 14.25 x 10.0 x 0.136  |
| 1T1835                 | FM4075          | BRONZE   | 4 PASS            | 114             | INT TH    | 412.0 x 285.0 x 4.9 16.22 x 11.22 x 0.193 |
| 1T1897                 | FM3438MP        | STEEL    | -----             | 166             | EXT TH    | 426.6 x 299.0 x 3.4 16.8 x 11.77 x 0.134  |
| 3T0618                 | FM2387          | GRAPHITE | SPR/RAD           | 65              | INT TH    | 283.3 x 204.2 x 5.0 11.15 x 8.04 x 0.197  |
| 3T1407                 | FM3163          | PAPER    | SUN/RAD           | 48              | INT TH    | 282.0 x 172.0 x 5.0 11.1 x 6.77 x 0.196   |
| 3T2466                 | FM2751          | GRAPHITE | SPR/RAD/WAG       | 85              | INT TH    | 381.0 x 307.3 x 5.6 15.0 x 12.1 x 0.22    |
| 3T2567                 | FM3384MP        | STEEL    | -----             | 43              | (64)EX TH | 205.5 x 145.4 x 3.5 8.09 x 5.72 x 0.138   |
| 3T3065                 | FM2750MP        | STEEL    | -----             | 52              | EXT TH    | 390.7 x 320.3 x 6.4 15.38 x 12.61 x 0.25  |
| 3T3089                 | FM2982MP        | STEEL    | -----             | 6               | EXT LG    | 584.2 x 453.4 x 6.4 23.0 x 17.85 x 0.25   |
| 3T3400                 | FM3667          | PAPER    | 2 PASS            | 44              | INT TH    | 196.9 x 138.0 x 2.8 7.75 x 5.43 x 0.11    |

| REPLACES<br>OEM PT.NO. | FMC<br>PART NO. | MATERIAL | GROOVE<br>DETAILS | TEETH/<br>TANGS | SIZE MM |       |   | SIZE INCH |   |     |       |   |       |   |       |
|------------------------|-----------------|----------|-------------------|-----------------|---------|-------|---|-----------|---|-----|-------|---|-------|---|-------|
| 3T4026                 | FM2261          | PAPER    | 2 PASS            | 61              | INT TH  | 281.7 | x | 220.0     | x | 4.9 | 11.09 | x | 8.66  | x | 0.193 |
| 3T6220                 | FM2939          | PAPER    | SUN/RAD           | 54              | INT TH  | 235.0 | x | 133.0     | x | 5.0 | 9.25  | x | 5.24  | x | 0.197 |
| 3T6338                 | FM2917          | PAPER    | 2 PASS            | 50              | INT TH  | 225.7 | x | 155.9     | x | 2.9 | 8.89  | x | 6.14  | x | 0.114 |
| 3T6339                 | FM6207          | PAPER    | 2 PASS            | 52              | INT TH  | 294.0 | x | 161.0     | x | 3.5 | 11.57 | x | 6.34  | x | 0.138 |
| 3T6340                 | FM3237          | PAPER    | 2 PASS            | 40              | INT TH  | 192.9 | x | 124.1     | x | 2.9 | 7.59  | x | 4.89  | x | 0.114 |
| 3T6620                 | FM2939          | PAPER    | SUN/RAD           | 54              | INT TH  | 235.0 | x | 133.0     | x | 5.0 | 9.25  | x | 5.24  | x | 0.197 |
| 3T9293                 | FM3565          | BRONZE   | RADIAL            | 68              | EXT TH  | 112.3 | x | 71.3      | x | 2.1 | 4.42  | x | 2.81  | x | 0.083 |
| 3T9960                 | FM2263          | PAPER    | 2 PASS            | 35              | INT TH  | 184.7 | x | 125.7     | x | 4.9 | 7.27  | x | 4.95  | x | 0.193 |
| 3T9961                 | FM2261          | PAPER    | 2 PASS            | 61              | INT TH  | 281.7 | x | 220.0     | x | 4.9 | 11.09 | x | 8.66  | x | 0.193 |
| 6T0473                 | FM3309          | BRONZE   | SUNBURST          | 104             | INT TH  | 464.0 | x | 325.7     | x | 4.7 | 18.27 | x | 12.82 | x | 0.185 |
| 6T0548                 | FM3305          | GRAPHITE | SUNBURST          | 104             | INT TH  | 464.0 | x | 325.7     | x | 4.8 | 18.27 | x | 12.82 | x | 0.189 |
| 6T0871                 | FM5112MP        | STEEL    | -----             | 64              | EXT TH  | 479.3 | x | 341.3     | x | 3.2 | 18.87 | x | 13.44 | x | 0.126 |
| 6T1996                 | FM3260MP        | STEEL    | -----             | 5               | EXT LG  | 411.5 | x | 320.0     | x | 6.4 | 16.2  | x | 12.6  | x | 0.25  |
| 6T2696                 | FM2791          | PAPER    | SUNBURST          | 88              | INT TH  | 393.7 | x | 273.4     | x | 4.7 | 15.5  | x | 10.76 | x | 0.185 |
| 6T2697                 | FM2127          | GRAPHITE | SPR/RAD/WAG       | 80              | INT TH  | 432.1 | x | 337.8     | x | 5.6 | 17.01 | x | 13.3  | x | 0.22  |
| 6T2698                 | FM2979          | GRAPHITE | SPR/RAD/WAG       | 138             | INT TH  | 533.4 | x | 435.1     | x | 5.6 | 21.0  | x | 17.13 | x | 0.22  |
| 6T2699                 | FM2755          | GRAPHITE | SPR/RAD/WAG       | 124             | INT TH  | 482.6 | x | 388.4     | x | 5.6 | 19.0  | x | 15.29 | x | 0.22  |
| 6T3080                 | FM2312MP        | STEEL    | -----             | 128             | EXT LG  | 410.0 | x | 292.1     | x | 2.3 | 16.14 | x | 11.5  | x | 0.09  |
| 6T4943                 | FM2939          | PAPER    | SUN/RAD           | 54              | INT TH  | 235.0 | x | 133.0     | x | 5.0 | 9.25  | x | 5.24  | x | 0.197 |
| 6T4944                 | FM1449          | PAPER    | 2 PASS            | 75              | EXT TH  | 277.6 | x | 189.0     | x | 3.3 | 10.93 | x | 7.44  | x | 0.129 |
| 6T5099                 | FM1279          | PAPER    | 2 PASS            | 52              | INT TH  | 148.6 | x | 107.7     | x | 1.8 | 5.85  | x | 4.24  | x | 0.07  |
| 6T6277                 | FM4650MP        | STEEL    | -----             | 24              | EXT TH  | 108.2 | x | 76.2      | x | 1.2 | 4.26  | x | 3.0   | x | 0.045 |
| 6T6283                 | FM4647          | BRONZE   | SPR/RAD           | 34              | INT TH  | 100.0 | x | 68.2      | x | 1.6 | 3.94  | x | 2.69  | x | 0.061 |
| 6T6481                 | FM4646MP        | STEEL    | -----             | 12              | EXT TH  | 156.0 | x | 119.2     | x | 1.2 | 6.14  | x | 4.69  | x | 0.045 |
| 6T6482                 | FM4643          | BRONZE   | SPR/RAD           | 24              | INT TH  | 143.0 | x | 109.8     | x | 1.6 | 5.63  | x | 4.32  | x | 0.061 |
| 6T7013                 | FM2071          | PAPER    | 3 PASS            | 102             | INT TH  | 715.3 | x | 511.3     | x | 5.1 | 28.16 | x | 20.13 | x | 0.2   |
| 6T7014                 | FM1963          | PAPER    | 3 PASS            | 62              | INT TH  | 495.3 | x | 308.1     | x | 5.1 | 19.5  | x | 12.13 | x | 0.2   |
| 6T7015                 | FM1491          | PAPER    | 3 PASS            | 60              | INT TH  | 462.5 | x | 299.7     | x | 5.1 | 18.21 | x | 11.8  | x | 0.2   |
| 6T7016                 | FM2665          | PAPER    | 3 PASS            | 68              | INT TH  | 462.5 | x | 340.6     | x | 5.1 | 18.21 | x | 13.41 | x | 0.2   |
| 6T7467                 | FM1279          | PAPER    | 2 PASS            | 52              | INT TH  | 148.6 | x | 107.7     | x | 1.8 | 5.85  | x | 4.24  | x | 0.07  |
| 6T8533                 | FM2277          | BRONZE   | SUNBURST          | 27              | EXT TH  | 137.4 | x | 90.9      | x | 2.0 | 5.41  | x | 3.58  | x | 0.079 |
| 6T8686                 | FM1825          | PAPER    | 2 PASS            | 54              | INT TH  | 215.0 | x | 168.4     | x | 2.9 | 8.46  | x | 6.63  | x | 0.116 |
| 6T8687                 | FM2255          | PAPER    | 2 PASS            | 36              | INT TH  | 144.0 | x | 87.9      | x | 3.0 | 5.67  | x | 3.46  | x | 0.118 |
| 6T8886                 | FM2378MP        | STEEL    | -----             | 8               | INT LG  | 393.7 | x | 273.8     | x | 2.4 | 15.5  | x | 10.78 | x | 0.094 |
| 6T9194                 | FM1324MP        | STEEL    | -----             | 54              | EXT TH  | 139.2 | x | 98.6      | x | 1.8 | 5.48  | x | 3.88  | x | 0.07  |
| 6T9456                 | FM2448MP        | STEEL    | -----             | 60              | EXT TH  | 154.2 | x | 113.8     | x | 3.1 | 6.07  | x | 4.48  | x | 0.123 |
| 6T9486                 | FM3382FP        | STEEL    | FLEXI PLATE       | 6               | HOLE    | 339.7 | x | 133.4     | x | 1.5 | 13.37 | x | 5.25  | x | 0.059 |
| 6T9487                 | FM4442FP        | STEEL    | REINF PLATE       | 6               | HOLE    | 186.5 | x | 132.0     | x | 2.1 | 7.34  | x | 5.2   | x | 0.83  |
| 7T2336                 | FM1631          | BRONZE   | SPR/RAD           | 96              | INT TH  | 381.0 | x | 300.0     | x | 5.6 | 15.0  | x | 11.81 | x | 0.22  |
| 7T2476                 | FM2387          | GRAPHITE | SPR/RAD           | 65              | INT TH  | 283.3 | x | 204.2     | x | 5.0 | 11.15 | x | 8.04  | x | 0.197 |
| 7T2629                 | FM2071          | PAPER    | 3 PASS            | 102             | INT TH  | 715.3 | x | 511.3     | x | 5.1 | 28.16 | x | 20.13 | x | 0.2   |
| 7T2742                 | FM3382FP        | STEEL    | FLEXI PLATE       | 6               | HOLE    | 339.7 | x | 133.4     | x | 1.5 | 13.37 | x | 5.25  | x | 0.059 |
| 7T2815                 | FM2471          | PAPER    | 3 PASS            | 120             | INT TH  | 874.5 | x | 603.0     | x | 5.1 | 34.43 | x | 23.74 | x | 0.2   |
| 7T3126                 | FM1324MP        | STEEL    | -----             | 54              | EXT TH  | 139.2 | x | 98.6      | x | 1.8 | 5.48  | x | 3.88  | x | 0.07  |
| 7T3302                 | FM3596MP        | STEEL    | -----             | 29              | INT TH  | 131.1 | x | 85.1      | x | 2.5 | 5.16  | x | 3.35  | x | 0.098 |
| 7T3303                 | FM3594MP        | STEEL    | -----             | 29              | INT TH  | 131.1 | x | 85.1      | x | 2.0 | 5.16  | x | 3.35  | x | 0.079 |
| 7T3326                 | FM3592MP        | STEEL    | -----             | 29              | INT TH  | 131.1 | x | 85.1      | x | 1.5 | 5.16  | x | 3.35  | x | 0.059 |



# Caterpillar 140 G&H Grader Discs

---



| REPLACES<br>OEM PT.NO. | FMC<br>PART NO. | MATERIAL  | GROOVE<br>DETAILS | TEETH/<br>TANGS | SIZE MM   |       |   | SIZE INCH |   |      |       |   |       |   |       |
|------------------------|-----------------|-----------|-------------------|-----------------|-----------|-------|---|-----------|---|------|-------|---|-------|---|-------|
| 7T3343                 | FM6476MP        | STEEL     | -----             | 6               | EXT LG    | 333.5 | x | 237.0     | x | 3.2  | 13.13 | x | 9.33  | x | 0.126 |
| 7T3456                 | FM4607          | PAPER     | 2 PASS            | 63              | INT TH    | 287.0 | x | 226.0     | x | 5.0  | 11.3  | x | 8.9   | x | 0.195 |
| 7T3861                 | FM3196MP        | STEEL     | -----             | 30              | EXT TH    | 200.0 | x | 140.0     | x | 3.0  | 7.87  | x | 5.51  | x | 0.118 |
| 7T4998                 | FM3199          | PAPER     | 2 PASS            | 52              | INT TH    | 190.0 | x | 128.0     | x | 4.0  | 7.48  | x | 5.04  | x | 0.157 |
| 7T5367                 | FM3596MP        | STEEL     | -----             | 29              | INT TH    | 131.1 | x | 85.1      | x | 2.5  | 5.16  | x | 3.35  | x | 0.098 |
| 7T5368                 | FM3594MP        | STEEL     | -----             | 29              | INT TH    | 131.1 | x | 85.1      | x | 2.0  | 5.16  | x | 3.35  | x | 0.079 |
| 7T5726                 | FM2375          | CARBON PA | SUNBURST          | 88              | INT TH    | 393.7 | x | 273.3     | x | 4.7  | 15.5  | x | 10.76 | x | 0.185 |
| 7T6218                 | FM3650MP        | STEEL     | -----             | 54              | EXT TH    | 139.2 | x | 98.6      | x | 3.0  | 5.48  | x | 3.88  | x | 0.118 |
| 7T6219                 | FM5118MP        | STEEL     | -----             | 52              | EXT TH    | 168.0 | x | 117.5     | x | 3.0  | 6.61  | x | 4.63  | x | 0.118 |
| 7T6994                 | FM2478MP        | STEEL     | -----             | 128             | EXT TH    | 410.0 | x | 292.1     | x | 3.2  | 16.14 | x | 11.5  | x | 0.125 |
| 7T7067                 | FM1963          | PAPER     | 3 PASS            | 62              | INT TH    | 495.3 | x | 308.1     | x | 5.1  | 19.5  | x | 12.13 | x | 0.2   |
| 7T7772                 | FM1825          | PAPER     | 2 PASS            | 54              | INT TH    | 215.0 | x | 168.4     | x | 2.9  | 8.46  | x | 6.63  | x | 0.116 |
| 7U4134                 | FM3837          | ORGANIC   | RADIAL            | 17              | INT TH    | 204.0 | x | 51.0      | x | 12.8 | 8.03  | x | 2.0   | x | 0.5   |
| 8U2375                 | FM4686MP        | STEEL     | -----             | 81              | EXT TH    | 243.6 | x | 152.1     | x | 2.5  | 9.59  | x | 5.99  | x | 0.098 |
| 8U2376                 | FM4089          | PAPER     | 3 PASS            | 48              | INT TH    | 232.7 | x | 142.0     | x | 4.0  | 9.16  | x | 5.59  | x | 0.157 |
| 8U5700                 | FM4794MP        | STEEL     | -----             | 87              | (90)EX TH | 189.1 | x | 130.6     | x | 3.0  | 7.44  | x | 5.14  | x | 0.118 |
| 8U5985 3.0MM           | FM7038MP        | STEEL     | HARD/BLACK        | 64              | EXT TH    | 196.4 | x | 140.0     | x | 2.9  | 7.73  | x | 5.51  | x | 0.114 |
| 8U5987                 | FM7038-3.5      | STEEL     | HARD/BLACK        | 64              | EXT TH    | 196.4 | x | 140.0     | x | 3.5  | 7.73  | x | 5.51  | x | 0.138 |
| 8U5988                 | FM4933          | BRONZE    | WAF/WAG           | 45              | INT TH    | 187.0 | x | 132.6     | x | 3.0  | 7.36  | x | 5.22  | x | 0.118 |
| 8U9507                 | FM6896MP        | STEEL     | -----             | 81              | EXT TH    | 243.6 | x | 152.1     | x | 2.0  | 9.59  | x | 5.99  | x | 0.079 |
| 8U9508                 | FM4686MP        | STEEL     | -----             | 81              | EXT TH    | 243.6 | x | 152.1     | x | 2.5  | 9.59  | x | 5.99  | x | 0.098 |
| 8U9509                 | FM6120-3.0      | STEEL     | -----             | 81              | EXT TH    | 243.5 | x | 153.0     | x | 3.0  | 9.59  | x | 6.02  | x | 0.118 |
| 8U9541                 | FM3353KIT       | CAT206    | BRAKE KIT         |                 |           |       |   |           |   |      |       |   |       |   |       |
| 8U9543                 | FM4686MP        | STEEL     | -----             | 81              | EXT TH    | 243.6 | x | 152.1     | x | 2.5  | 9.59  | x | 5.99  | x | 0.098 |
| 9U1738                 | FM7303          | CARBON PA | WAFFLE            | 62              | INT TH    | 462.0 | x | 192.0     | x | 6.2  | 18.19 | x | 7.56  | x | 0.244 |
| 9U1739                 | FM4920MP        | STEEL     | -----             | 94              | EXT TH    | 486.0 | x | 296.0     | x | 7.3  | 19.13 | x | 11.65 | x | 0.287 |
| 9U9829                 | FM6972MP        | STEEL     | -----             | 6               | EXT LG    | 491.7 | x | 356.0     | x | 6.8  | 19.36 | x | 14.02 | x | 0.268 |
| 9U9844                 | FM8346MP        | STEEL     | -----             | 6               | EXT LG    | 625.2 | x | 453.8     | x | 6.4  | 24.61 | x | 17.83 | x | 0.252 |
| 9U9845                 | FM8348MP        | STEEL     | END PLATE         | 6               | EXT LG    | 625.3 | x | 454.0     | x | 6.4  | 24.62 | x | 17.87 | x | 0.252 |
| 9U9995                 | FM3198MP        | STEEL     | -----             | 32              | EXT TH    | 225.0 | x | 138.0     | x | 3.0  | 8.86  | x | 5.43  | x | 0.118 |
| 9U9999                 | FM2751          | GRAPHITE  | SPR/RAD/WAG       | 85              | INT TH    | 381.0 | x | 307.3     | x | 5.6  | 15    | x | 12.1  | x | 0.22  |
| 1V8279                 | FM1785          | IRON      | RADIAL            | 62              | INT TH    | 311.2 | x | 192.9     | x | 5.0  | 12.25 | x | 7.59  | x | 0.197 |
| 1V8280                 | FM1784MP        | STEEL     | -----             | 102             | EXT TH    | 327.9 | x | 209.4     | x | 6.4  | 12.89 | x | 8.24  | x | 0.251 |
| 1V8281                 | FM1784MP        | STEEL     | -----             | 102             | EXT TH    | 327.9 | x | 209.4     | x | 6.4  | 12.89 | x | 8.24  | x | 0.251 |
| 2V7268                 | FM1491          | PAPER     | 3 PASS            | 60              | INT TH    | 462.5 | x | 299.7     | x | 5.1  | 18.21 | x | 11.8  | x | 0.2   |
| 2V7269                 | FM1490MP        | STEEL     | -----             | 94              | EXT TH    | 486.9 | x | 318.3     | x | 2.4  | 19.17 | x | 12.53 | x | 0.095 |
| 5V0009                 | FM1490MP        | STEEL     | -----             | 94              | EXT TH    | 486.9 | x | 318.3     | x | 2.4  | 19.17 | x | 12.53 | x | 0.095 |
| 5V0021                 | FM2880MP        | STEEL     | -----             | 94              | EXT TH    | 486.9 | x | 357.6     | x | 2.4  | 19.17 | x | 14.08 | x | 0.094 |
| 5V0593                 | FM1617          | BRONZE    | SPR/WAG           | 95              | EXT TH    | 304.8 | x | 212.9     | x | 4.3  | 12.0  | x | 8.38  | x | 0.168 |
| 5V5208                 | FM2665          | PAPER     | 3 PASS            | 68              | INT TH    | 462.5 | x | 340.6     | x | 5.1  | 18.21 | x | 13.41 | x | 0.2   |
| 5V5209                 | FM2880MP        | STEEL     | -----             | 94              | EXT TH    | 486.9 | x | 357.6     | x | 2.4  | 19.17 | x | 14.08 | x | 0.094 |
| 5V7657                 | FM1784MP        | STEEL     | -----             | 102             | EXT TH    | 327.9 | x | 209.4     | x | 6.4  | 12.89 | x | 8.24  | x | 0.251 |
| 9V6164                 | FM2880MP        | STEEL     | -----             | 94              | EXT TH    | 486.9 | x | 357.6     | x | 2.4  | 19.17 | x | 14.08 | x | 0.094 |
| 9V6165                 | FM1490MP        | STEEL     | -----             | 94              | EXT TH    | 486.9 | x | 318.3     | x | 2.4  | 19.17 | x | 12.53 | x | 0.095 |
| 3W4329                 | FM4499          | PAPER     | RAD/WAG           | 104             | INT TH    | 393.0 | x | 328.0     | x | 4.7  | 15.47 | x | 12.91 | x | 0.185 |
| 3W5159                 | FM3506MP        | STEEL     | -----             | 50              | INT TH    | 229.0 | x | 77.0      | x | 2.3  | 9.02  | x | 3.03  | x | 0.091 |
| 5W5688                 | FM5468MP        | STEEL     | -----             | 87              | (90)EX TH | 189.1 | x | 130.6     | x | 2.0  | 7.44  | x | 5.14  | x | 0.079 |
| 5W5690                 | FM3575          | PAPER     | 3 PASS            | 35              | INT TH    | 179.0 | x | 103.0     | x | 3.5  | 7.05  | x | 4.05  | x | 0.138 |

| REPLACES<br>OEM PT.NO. | FMC<br>PART NO. | MATERIAL  | GROOVE<br>DETAILS | TEETH/<br>TANGS | SIZE MM    | SIZE INCH                                 |
|------------------------|-----------------|-----------|-------------------|-----------------|------------|---|
| 5W5737                 | FM4650MP        | STEEL     | -----             | 24              | EXT TH     | 108.2 x 76.2 x 1.2 4.26 x 3.0 x 0.045     |
| 5W5743                 | FM4646MP        | STEEL     | -----             | 12              | EXT TH     | 156.0 x 119.2 x 1.2 6.14 x 4.69 x 0.045   |
| 5W5744                 | FM4643          | BRONZE    | SPR/RAD           | 24              | INT TH     | 143.0 x 109.8 x 1.6 5.63 x 4.32 x 0.061   |
| 5W5747                 | FM4647          | BRONZE    | SPR/RAD           | 34              | INT TH     | 100.0 x 68.2 x 1.6 3.94 x 2.69 x 0.061    |
| 5W8310                 | FM3870MP        | STEEL     | -----             | 87              | (90)EX TH  | 189.1 x 130.6 x 2.5 7.44 x 5.14 x 0.098   |
| 8W0212                 | FM2462MP        | STEEL     | -----             | 176             | EXT TH     | 900.7 x 692.2 x 2.4 35.46 x 27.25 x 0.094 |
| 8W9707                 | FM4337          | CORK      | -----             | 94              | EXT TH     | 486.7 x 357.6 x 6.9 19.16 x 14.08 x 0.272 |
| 9W0473                 | FM1641          | ORGANIC   | -----             |                 | LINING     | 137.2 x 31.8 x 4.7 5.4 x 1.25 x 0.185     |
| 9W1735                 | FM2829          | PAPER     | 2 PASS            | 45              | INT TH     | 133.1 x 92.7 x 2.1 5.24 x 3.65 x 0.083    |
| 9W2473                 | FM2127          | GRAPHITE  | SPR/RAD/WAG       | 80              | INT TH     | 432.1 x 337.8 x 5.6 17.01 x 13.3 x 0.22   |
| 9W2697                 | FM3139          | PAPER     | WAFFLE            | 54              | INT TH     | 216.0 x 135.0 x 4.6 8.5 x 5.31 x 0.181    |
| 9W4662                 | FM2765          | BRONZE    | SPR/WAG           | 65              | INT TH     | 286.0 x 204.0 x 4.9 11.26 x 8.03 x 0.193  |
| 9W4954                 | FM3813          | TAN PAPER | 2 PASS            | 50              | (52) IN TH | 148.6 x 107.7 x 2.7 5.85 x 4.24 x 0.108   |
| 9W4954                 | FM5295          | GREEN PA  | 2 PASS            | 50              | (52) IN TH | 148.6 x 107.7 x 2.7 5.85 x 4.24 x 0.108   |
| 9W7017                 | FM2071          | PAPER     | 3 PASS            | 102             | INT TH     | 715.3 x 511.3 x 5.1 28.16 x 20.13 x 0.2   |
| 9W7018                 | FM1963          | PAPER     | 3 PASS            | 62              | INT TH     | 495.3 x 308.1 x 5.1 19.5 x 12.13 x 0.2    |
| 9W7019                 | FM1491          | PAPER     | 3 PASS            | 60              | INT TH     | 462.5 x 299.7 x 5.1 18.21 x 11.8 x 0.2    |
| 9W7020                 | FM2665          | PAPER     | 3 PASS            | 68              | INT TH     | 462.5 x 340.6 x 5.1 18.21 x 13.41 x 0.2   |
| 9W7032                 | FM2979          | GRAPHITE  | SPR/RAD/WAG       | 138             | INT TH     | 533.4 x 435.1 x 5.6 21.0 x 17.13 x 0.22   |
| ALTERNATIVE            | FM6767          | CARBON    | WAFFLE            | 138             | INT TH     | 533.4 x 435.1 x 5.6 21.0 x 17.13 x 0.22   |
| 9W7077                 | FM2755          | GRAPHITE  | SPR/RAD/WAG       | 124             | INT TH     | 482.6 x 388.4 x 5.6 19.0 x 15.29 x 0.22   |
| 9W7088                 | FM2755          | GRAPHITE  | SPR/RAD/WAG       | 124             | INT TH     | 482.6 x 388.4 x 5.6 19.0 x 15.29 x 0.22   |
| 9W7089                 | FM2751          | GRAPHITE  | SPR/RAD/WAG       | 85              | INT TH     | 381.0 x 307.3 x 5.6 15.0 x 12.1 x 0.22    |
| 9W7090                 | FM2245          | GRAPHITE  | SPR/RAD           | 75              | INT TH     | 344.9 x 271.0 x 5.6 13.58 x 10.67 x 0.222 |
| 9W7464                 | FM2478MP        | STEEL     | -----             | 128             | EXT TH     | 410.0 x 292.1 x 3.2 16.14 x 11.5 x 0.125  |
| 9W8901                 | FM1279          | PAPER     | 2 PASS            | 52              | INT TH     | 148.6 x 107.7 x 1.8 5.85 x 4.24 x 0.07    |
| 9W9856                 | FM4157          | ELASTOMER | SPR/RAD/WAG       | 80              | INT TH     | 432.1 x 337.8 x 5.6 17.01 x 13.3 x 0.22   |
| ALTERNATIVE            | FM6283          | CARBON    | WAFFLE            | 80              | INT TH     | 432.1 x 337.8 x 5.6 17.01 x 13.3 x 0.22   |
| 8X4435                 | FM2435          | CORK      | -----             | 110             | EXT TH     | 565.9 x 426.0 x 6.9 22.28 x 16.77 x 0.27  |
| 8X4437                 | FM2438MP        | STEEL     | -----             | 110             | EXT TH     | 565.9 x 426.0 x 2.4 22.28 x 16.77 x 0.095 |
| 8X7876                 | FM4536-4.0      | STEEL     | HARDENED          | 4               | EXT LG     | 211.2 x 102.3 x 4.0 8.31 x 4.03 x 0.157   |
| 8X7882                 | FM4536-3.9      | STEEL     | HARDENED          | 4               | EXT LG     | 211.2 x 102.3 x 3.9 8.31 x 4.03 x 0.154   |
| 8X7883                 | FM4536MP        | STEEL     | HARDENED          | 4               | EXT LG     | 211.2 x 102.3 x 4.1 8.31 x 4.03 x 0.161   |
| 9X0511                 | FM1279          | PAPER     | 2 PASS            | 52              | INT TH     | 148.6 x 107.7 x 1.8 5.85 x 4.24 x 0.07    |
| 2Y4654                 | FM1635          | BRONZE    | SPR/WAG           | 64              | INT TH     | 355.6 x 200.2 x 7.1 14.0 x 7.88 x 0.28    |
| 2Y5134                 | FM1617          | BRONZE    | SPR/WAG           | 95              | EXT TH     | 304.8 x 212.9 x 4.3 12 x 8.38 x 0.168     |
| 2Y8267                 | FM1908MP        | STEEL     | -----             | 5               | EXT LG     | 411.5 x 317.5 x 6.4 16.2 x 12.5 x 0.25    |
| 3Y7363                 | FM1635          | BRONZE    | SPR/WAG           | 64              | INT TH     | 355.6 x 200.2 x 7.1 14 x 7.88 x 0.28      |
| 4Y0709                 | FM2409          | PAPER     | SUNBURST          | 120             | EXT TH     | 384.6 x 291.3 x 4.6 15.14 x 11.47 x 0.18  |
| 6Y0063                 | FM4157          | ELASTOMER | SPR/RAD/WAG       | 80              | INT TH     | 432.1 x 337.8 x 5.6 17.01 x 13.3 x 0.22   |
| ALTERNATIVE            | FM6283          | CARBON    | WAFFLE            | 80              | INT TH     | 432.1 x 337.8 x 5.6 17.01 x 13.3 x 0.22   |
| 6Y1268                 | FM5112MP        | STEEL     | -----             | 64              | EXT TH     | 479.3 x 341.3 x 3.2 18.87 x 13.44 x 0.126 |
| 6Y1300                 | FM3255          | PAPER     | 2 PASS            | 45              | INT TH     | 160.0 x 92.7 x 4.0 6.3 x 3.65 x 0.157     |
| 6Y1320                 | FM2248MP        | STEEL     | -----             | 5               | EXT LG     | 380.0 x 284.0 x 5.0 14.96 x 11.18 x 0.197 |
| 6Y1363                 | FM2245          | GRAPHITE  | SPR/RAD           | 75              | INT TH     | 344.9 x 271.0 x 5.6 13.58 x 10.67 x 0.22  |
| 6Y1697                 | FM1825          | PAPER     | 2 PASS            | 54              | INT TH     | 215.0 x 168.4 x 2.9 8.46 x 6.63 x 0.116   |
| 6Y2024                 | FM5112MP        | STEEL     | -----             | 64              | EXT TH     | 479.3 x 341.3 x 3.2 18.87 x 13.44 x 0.126 |



| REPLACES<br>OEM PT.NO. | FMC<br>PART NO. | MATERIAL  | GROOVE<br>DETAILS | TEETH/<br>TANGS | SIZE MM |       |   | SIZE INCH |   |     |       |   |       |   |       |
|------------------------|-----------------|-----------|-------------------|-----------------|---------|-------|---|-----------|---|-----|-------|---|-------|---|-------|
| 6Y2027                 | FM1967          | PAPER     | 2 PASS            | 101             | INT TH  | 311.2 | x | 253       | x | 5.1 | 12.25 | x | 9.96  | x | 0.2   |
| 6Y2082                 | FM7379          | CARBON PA | WAFFLE            | 18              | INT TH  | 379.0 | x | 79.3      | x | 9.1 | 14.92 | x | 3.12  | x | 0.358 |
| 6Y2083                 | FM4211          | PAPER     | 2 PASS            | 18              | INT TH  | 270.0 | x | 60.0      | x | 7.0 | 10.63 | x | 2.36  | x | 0.276 |
| 6Y2084                 | FM7381          | CARBON PA | WAFFLE            | 18              | INT TH  | 402.0 | x | 82.9      | x | 9.1 | 15.83 | x | 3.26  | x | 0.358 |
| 6Y2085                 | FM4827          | PAPER     | 2 PASS            | 18              | INT TH  | 299.5 | x | 65.3      | x | 7.0 | 11.79 | x | 2.57  | x | 0.276 |
| 6Y2089                 | FM6963          | CARBON PA | WAFFLE            | 18              | INT TH  | 422.0 | x | 88.0      | x | 9.1 | 16.61 | x | 3.46  | x | 0.358 |
| 6Y2197                 | FM1641          | ORGANIC   | -----             |                 | LINING  | 137.2 | x | 31.8      | x | 4.7 | 5.4   | x | 1.25  | x | 0.185 |
| 6Y2441                 | FM2854MP        | STEEL     | -----             | 6               | EXT LG  | 482.0 | x | 355.6     | x | 6.7 | 19.0  | x | 14    | x | 0.265 |
| 6Y3934                 | FM3831          | PAPER     | 2 PASS            | 56              | EXT TH  | 239.0 | x | 157.0     | x | 4.0 | 9.41  | x | 6.18  | x | 0.157 |
| 6Y4250                 | FM3309          | BRONZE    | SUNBURST          | 104             | INT TH  | 464.0 | x | 325.7     | x | 4.7 | 18.27 | x | 12.82 | x | 0.185 |
| 6Y4912                 | FM2701          | ORGANIC   | -----             | 71              | EXT TH  | 303.5 | x | 213.0     | x | 4.9 | 11.95 | x | 8.38  | x | 0.193 |
| 6Y5348                 | FM1451          | PAPER     | 2 PASS            | 87              | EXT TH  | 277.9 | x | 209.6     | x | 5.0 | 10.94 | x | 8.25  | x | 0.196 |
| 6Y5352                 | FM2261          | PAPER     | 2 PASS            | 61              | INT TH  | 281.7 | x | 220.0     | x | 4.9 | 11.09 | x | 8.66  | x | 0.193 |
| 6Y5631                 | FM3650MP        | STEEL     | -----             | 54              | EXT TH  | 139.2 | x | 98.6      | x | 3.0 | 5.48  | x | 3.88  | x | 0.118 |
| 6Y5632                 | FM3196MP        | STEEL     | -----             | 30              | EXT TH  | 200.0 | x | 140.0     | x | 3.0 | 7.87  | x | 5.51  | x | 0.118 |
| 6Y5692                 | FM2848MP        | STEEL     | -----             | 126             | EXT TH  | 402.0 | x | 338.0     | x | 2.3 | 15.83 | x | 13.3  | x | 0.091 |
| 6Y5911                 | FM2243          | PAPER     | SPR/RAD           | 75              | INT TH  | 344.9 | x | 271.0     | x | 5.6 | 13.58 | x | 10.67 | x | 0.222 |
| 6Y5912                 | FM2249          | PAPER     | 2 PASS            | 48              | INT TH  | 240.0 | x | 172.7     | x | 5.1 | 9.45  | x | 6.8   | x | 0.2   |
| 6Y5913                 | FM4039          | PAPER     | 2 PASS            | 18              | INT TH  | 333.5 | x | 70.0      | x | 8.3 | 13.13 | x | 2.75  | x | 0.325 |
| 6Y5914                 | FM1825          | PAPER     | 2 PASS            | 54              | INT TH  | 215.0 | x | 168.4     | x | 2.9 | 8.46  | x | 6.63  | x | 0.116 |
| 6Y5915                 | FM2303          | PAPER     | RAD/WAG           | 81              | INT TH  | 264.9 | x | 201.8     | x | 4.6 | 10.43 | x | 7.95  | x | 0.183 |
| 6Y5916                 | FM1513          | PAPER     | 2 PASS            | 96              | INT TH  | 381.0 | x | 300.0     | x | 5.6 | 15.0  | x | 11.81 | x | 0.22  |
| 6Y7160                 | FM1603          | BRONZE    | -----             | 120             | EXT TH  | 384.8 | x | 292.6     | x | 4.7 | 15.15 | x | 11.52 | x | 0.187 |
| 6Y7198                 | FM7942MP        | STEEL     | -----             | 130             | EXT TH  | 555.4 | x | 435.1     | x | 6.4 | 21.87 | x | 17.13 | x | 0.25  |
| 6Y7218                 | FM2979          | GRAPHITE  | SPR/RAD/WAG       | 138             | INT TH  | 533.4 | x | 435.1     | x | 5.6 | 21.0  | x | 17.13 | x | 0.22  |
| ALTERNATIVE            | FM6767          | CARBON    | WAFFLE            | 138             | INT TH  | 533.4 | x | 435.1     | x | 5.6 | 21.0  | x | 17.13 | x | 0.22  |
| 6Y7219                 | FM2755          | GRAPHITE  | SPR/RAD/WAG       | 124             | INT TH  | 482.6 | x | 388.4     | x | 5.6 | 19.0  | x | 15.29 | x | 0.22  |
| 6Y7220                 | FM2127          | GRAPHITE  | SPR/RAD/WAG       | 80              | INT TH  | 432.1 | x | 337.8     | x | 5.6 | 17.01 | x | 13.3  | x | 0.22  |
| 6Y7857                 | FM2829          | PAPER     | 2 PASS            | 45              | INT TH  | 133.1 | x | 92.7      | x | 2.1 | 5.24  | x | 3.65  | x | 0.083 |
| 6Y7909                 | FM3257          | PAPER     | WAFFLE            | 18              | INT TH  | 110.0 | x | 54.0      | x | 5.2 | 4.33  | x | 2.13  | x | 0.205 |
| 6Y7914                 | FM1879          | PAPER     | 2 PASS            | 95              | EXT TH  | 304.8 | x | 212.9     | x | 3.5 | 12.0  | x | 8.38  | x | 0.138 |
| 6Y7915                 | FM1405          | PAPER     | 2 PASS            | 54              | INT TH  | 255.5 | x | 168.4     | x | 2.8 | 10.06 | x | 6.63  | x | 0.112 |
| 6Y7916                 | FM1407          | PAPER     | 2 PASS            | 64              | INT TH  | 306.6 | x | 198.4     | x | 3.5 | 12.07 | x | 7.81  | x | 0.136 |
| 6Y7917                 | FM1413          | PAPER     | 2 PASS            | 88              | INT TH  | 407.9 | x | 274.1     | x | 3.8 | 16.06 | x | 10.79 | x | 0.15  |
| 6Y7919                 | FM2415          | PAPER     | 2 PASS            | 24              | INT TH  | 120.4 | x | 73.4      | x | 3.0 | 4.74  | x | 2.89  | x | 0.118 |
| 6Y7920                 | FM1449          | PAPER     | 2 PASS            | 75              | EXT TH  | 277.6 | x | 189.0     | x | 3.3 | 10.93 | x | 7.44  | x | 0.129 |
| 6Y7921                 | FM2113          | PAPER     | 2 PASS            | 32              | EXT TH  | 224.8 | x | 165.1     | x | 4.3 | 8.85  | x | 6.5   | x | 0.17  |
| 6Y7922                 | FM3201          | PAPER     | 2 PASS            | 52              | INT TH  | 160.0 | x | 108.0     | x | 4.0 | 6.3   | x | 4.25  | x | 0.157 |
| 6Y7923                 | FM2643          | PAPER     | 2 PASS            | 40              | EXT TH  | 280.4 | x | 200.0     | x | 4.3 | 11.04 | x | 7.87  | x | 0.169 |
| 6Y7925                 | FM2939          | PAPER     | SUN/RAD           | 54              | INT TH  | 235.0 | x | 133.0     | x | 5.0 | 9.25  | x | 5.24  | x | 0.197 |
| 6Y7929                 | FM2829          | PAPER     | 2 PASS            | 45              | INT TH  | 133.1 | x | 92.7      | x | 2.1 | 5.24  | x | 3.65  | x | 0.083 |
| 6Y7932                 | FM3199          | PAPER     | 2 PASS            | 52              | INT TH  | 190.0 | x | 128.0     | x | 4.0 | 7.48  | x | 5.04  | x | 0.157 |
| 6Y7933                 | FM1279          | PAPER     | 2 PASS            | 52              | INT TH  | 148.6 | x | 107.7     | x | 1.8 | 5.85  | x | 4.24  | x | 0.07  |
| 6Y7934                 | FM2255          | PAPER     | 2 PASS            | 36              | INT TH  | 144.0 | x | 87.9      | x | 3.0 | 5.67  | x | 3.46  | x | 0.118 |
| 6Y7935                 | FM1825          | PAPER     | 2 PASS            | 54              | INT TH  | 215.0 | x | 168.4     | x | 2.9 | 8.46  | x | 6.63  | x | 0.116 |
| 6Y7946                 | FM2791          | PAPER     | SUNBURST          | 88              | INT TH  | 393.7 | x | 273.4     | x | 4.7 | 15.5  | x | 10.76 | x | 0.185 |
| 6Y7950                 | FM3139          | PAPER     | WAFFLE            | 54              | INT TH  | 216.0 | x | 135.0     | x | 4.6 | 8.5   | x | 5.31  | x | 0.181 |
| 6Y7952                 | FM2881          | PAPER     | 3 PASS            | 58              | INT TH  | 266.2 | x | 181.6     | x | 4.8 | 10.48 | x | 7.15  | x | 0.19  |

| REPLACES<br>OEM PT.NO. | FMC<br>PART NO. | MATERIAL  | GROOVE<br>DETAILS | TEETH/<br>TANGS | SIZE MM   | SIZE INCH                                 |
|------------------------|-----------------|-----------|-------------------|-----------------|-----------|---|
| 6Y7953                 | FM2835          | PAPER     | -----             | 74              | INT TH    | 178.0 x 116.4 x 2.9 7.01 x 4.58 x 0.114   |
| 6Y7954                 | FM2917          | PAPER     | 2 PASS            | 50              | INT TH    | 225.7 x 155.9 x 2.9 8.89 x 6.14 x 0.114   |
| 6Y7955                 | FM3237          | PAPER     | 2 PASS            | 40              | INT TH    | 192.9 x 124.1 x 2.9 7.59 x 4.89 x 0.114   |
| 6Y7956                 | FM3085          | PAPER     | 2 PASS            | 24              | INT TH    | 177.6 x 73.3 x 5.2 6.99 x 2.88 x 0.205    |
| 6Y7957                 | FM2829          | PAPER     | 2 PASS            | 45              | INT TH    | 133.1 x 92.7 x 2.1 5.24 x 3.65 x 0.083    |
| 6Y7958                 | FM6207          | PAPER     | 2 PASS            | 52              | INT TH    | 294.0 x 161.0 x 3.5 11.57 x 6.34 x 0.138  |
| 6Y7961                 | FM3433          | PAPER     | 2 PASS            | 30              | INT TH    | 106.0 x 46.2 x 2.5 4.17 x 1.82 x 0.98     |
| 6Y7962                 | FM2365          | PAPER     | 2 PASS            | 18              | INT TH    | 105.9 x 43.4 x 2.5 4.17 x 1.71 x 0.1      |
| 6Y7964                 | FM3075          | PAPER     | 2 PASS            | 45              | INT TH    | 112.0 x 70.0 x 2.1 4.41 x 2.76 x 0.083    |
| 6Y7965                 | FM1825          | PAPER     | 2 PASS            | 54              | INT TH    | 215.0 x 168.4 x 2.9 8.46 x 6.63 x 0.116   |
| 6Y7968                 | FM3229          | PAPER     | 2 PASS            | 45              | INT TH    | 133.0 x 93.0 x 4.0 5.24 x 3.66 x 0.157    |
| 6Y7970                 | FM4211          | PAPER     | 2 PASS            | 18              | INT TH    | 270.0 x 60.0 x 7.0 10.63 x 2.36 x 0.276   |
| 6Y7977                 | FM1611          | BRONZE    | WAGON             | 120             | EXT TH    | 384.8 x 292.6 x 4.7 15.15 x 11.52 x 0.187 |
| 6Y7981                 | FM2113          | PAPER     | 2 PASS            | 32              | EXT TH    | 224.8 x 165.1 x 4.3 8.85 x 6.5 x 0.17     |
| 6Y8043                 | FM3662MP        | STEEL     | -----             | 52              | EXT TH    | 168.0 x 117.5 x 2.0 6.61 x 4.63 x 0.079   |
| 6Y8512                 | FM3194MP        | STEEL     | -----             | 36              | EXT TH    | 170.0 x 117.5 x 3.0 6.69 x 4.63 x 0.118   |
| 6Y8514                 | FM5530MP        | STEEL     | -----             | 36              | EXT TH    | 170.5 x 117.5 x 8.0 6.71 x 4.63 x 0.315   |
| 6Y8813                 | FM8177          | AFP       | 4 PASS            | 153             | INT TH    | 1010.4 x 768.4 x 5.1 39.78 x 30.25 x 0.2  |
| 6Y9354                 | FM5112MP        | STEEL     | -----             | 64              | EXT TH    | 479.3 x 341.3 x 3.2 18.87 x 13.44 x 0.126 |
| 6Y9372                 | FM4499          | PAPER     | RAD/WAG           | 104             | INT TH    | 393.0 x 328.0 x 4.7 15.47 x 12.91 x 0.185 |
| 6Y9373                 | FM2375          | CARBON PA | SUNBURST          | 88              | INT TH    | 393.7 x 273.3 x 4.7 15.5 x 10.76 x 0.185  |
| 6Y9432                 | FM5112MP        | STEEL     | -----             | 64              | EXT TH    | 479.3 x 341.3 x 3.2 18.87 x 13.44 x 0.126 |
| 6Y9807                 | FM2245          | GRAPHITE  | SPR/RAD           | 75              | INT TH    | 344.9 x 271.0 x 5.6 13.58 x 10.67 x 0.222 |
| 6Y9808                 | FM2751          | GRAPHITE  | SPR/RAD/WAG       | 85              | INT TH    | 381.0 x 307.3 x 5.6 15.0 x 12.1 x 0.22    |
| 7Y4214                 | FM9123          | PAPER     | 2 PASS            | 9               | INT LG    | 165.0 x 129.7 x 3.2 6.5 x 5.11 x 0.124    |
| 7Y4292                 | FM3395P         | PAPER     | 2 PASS            | 56              | (60)IN TH | 180.0 x 145.0 x 4.0 7.09 x 5.71 x 0.157   |
| 7Y4293                 | FM3398MP        | STEEL     | -----             | 12              | EXT LG    | 188.5 x 158.0 x 1.5 7.42 x 6.22 x 0.059   |
| 9Y3666                 | FM6131          | ELASTOMER | SPR/RAD/WAG       | 101             | INT TH    | 534.0 x 417.0 x 5.6 21.02 x 16.42 x 0.22  |
| ALTERNATIVE            | FM7547          | CARBON    | WAFFLE            | 101             | INT TH    | 534.0 x 417.0 x 5.6 21.02 x 16.42 x 0.22  |
| 9Y5083                 | FM6131          | ELASTOMER | SPR/RAD/WAG       | 101             | INT TH    | 534.0 x 417.0 x 5.6 21.02 x 16.42 x 0.22  |
| ALTERNATIVE            | FM7547          | CARBON    | WAFFLE            | 101             | INT TH    | 534.0 x 417.0 x 5.6 21.02 x 16.42 x 0.22  |
| 66782                  | FM3382FP        | STEEL     | FLEXI PLATE       | 6               | HOLE      | 339.7 x 133.4 x 1.5 13.37 x 5.25 x 0.059  |
| 215296                 | FM1274MP        | STEEL     | -----             | 20              | (28)EX TH | 191.3 x 117.3 x 2.0 7.53 x 4.62 x 0.079   |
| 216163                 | FM3669          | GRAPHITE  | SUNBURST          | 64              | INT TH    | 269.7 x 197.1 x 3.5 10.62 x 7.76 x 0.138  |
| 216173                 | FM1324MP        | STEEL     | -----             | 54              | EXT TH    | 139.2 x 98.6 x 1.8 5.48 x 3.88 x 0.07     |
| 375033                 | FM1247OE        | BRONZE    | SUNBURST          | 43              | (44)IN TH | 196.9 x 137.7 x 2.8 7.75 x 5.42 x 0.109   |
| 642971                 | FM3382KIT       | STEEL     | FLEXI PLATE       |                 |           |   |
| 642973                 | FM3382FP        | STEEL     | FLEXI PLATE       | 6               | HOLE      | 339.7 x 133.4 x 1.5 13.37 x 5.25 x 0.059  |
| 642974                 | FM4442FP        | STEEL     | REINF PLATE       | 6               | HOLE      | 186.5 x 132.0 x 2.1 7.34 x 5.2 x 0.083    |
| 643847                 | FM1900MP        | STEEL     | -----             | 64              | EXT TH    | 205.5 x 145.3 x 1.7 8.09 x 5.72 x 0.067   |
| 643848                 | FM1247OE        | BRONZE    | SUNBURST          | 43              | (44)IN TH | 196.9 x 137.7 x 2.8 7.75 x 5.42 x 0.109   |
| 695724                 | FM1279          | PAPER     | 2 PASS            | 52              | INT TH    | 148.6 x 107.7 x 1.8 5.85 x 4.24 x 0.07    |
| 909258                 | FM3142MP        | STEEL     | -----             | 53              | EXT TH    | 226.0 x 142.9 x 2.5 8.9 x 5.63 x 0.098    |
| 971076                 | FM5807          | BRONZE    | SPIRAL            | 25              | INT TH    | 147.5 x 74.3 x 4.0 5.81 x 2.93 x 0.157    |
| 971077                 | FM1381OE        | BRONZE    | RADIAL            | 52              | INT TH    | 148.6 x 107.7 x 2.9 5.85 x 4.24 x 0.114   |
| 972534                 | FM1230MP        | STEEL     | -----             | 4               | EXT LG    | 155.7 x 115.8 x 1.7 6.13 x 4.56 x 0.066   |
| 972668                 | FM2020MP        | STEEL     | -----             | 8               | EXT LG    | 136.4 x 88.1 x 1.2 5.37 x 3.47 x 0.047    |

| REPLACES<br>OEM PT.NO. | FMC<br>PART NO. | MATERIAL             | GROOVE<br>DETAILS | TEETH/<br>TANGS        | SIZE MM   |       |   | SIZE INCH |   |     |       |   |       |   |       |
|------------------------|-----------------|----------------------|-------------------|------------------------|-----------|-------|---|-----------|---|-----|-------|---|-------|---|-------|
| 972669                 | FM3704MP        | STEEL                | DISHED            | 8                      | EXT LG    | 136.4 | x | 88.1      | x | 1.2 | 5.37  | x | 3.47  | x | 0.047 |
| 972673                 | FM2309          | PAPER                | 2 PASS            | 42                     | INT TH    | 149.4 | x | 107.7     | x | 2.6 | 5.88  | x | 4.24  | x | 0.102 |
| 973587                 | FM1233          | BRONZE               | SPR/WAG           | 20                     | INT TH    | 168.9 | x | 78.5      | x | 3.3 | 6.65  | x | 3.09  | x | 0.13  |
| 973826                 | FM1216MP        | STEEL                | -----             | 60                     | EXT TH    | 154.2 | x | 113.8     | x | 1.8 | 6.07  | x | 4.48  | x | 0.07  |
| 977076                 | FM4472MP        | OBSOLETE AFTER STOCK |                   | 51                     | (55)EX TH | 284.1 | x | 196.3     | x | 2.5 | 11.19 | x | 7.73  | x | 0.098 |
| 982751                 | FM1801          | BRONZE               | WAFFLE            | 76                     | EXT TH    | 164.1 | x | 103.1     | x | 2.8 | 6.46  | x | 4.06  | x | 0.11  |
| 982774                 | FM5123          | BRONZE               | WAFFLE            | 88                     | EXT TH    | 189.5 | x | 117.6     | x | 3.1 | 7.46  | x | 4.63  | x | 0.122 |
| 1004910                | FM8756MP        | STEEL                | -----             | 4                      | EXT SL    | 434.0 | x | 305.9     | x | 5.4 | 17.09 | x | 12.04 | x | 0.213 |
| 1014838                | FM2122MP        | STEEL                | -----             | 4                      | EXT LG    | 137.7 | x | 80.0      | x | 2.2 | 5.42  | x | 3.15  | x | 0.087 |
| 1015141                | FM2881          | PAPER                | 3 PASS            | 58                     | INT TH    | 266.2 | x | 181.6     | x | 4.8 | 10.48 | x | 7.15  | x | 0.19  |
| 1015144                | FM4499          | PAPER                | RAD/WAG           | 104                    | INT TH    | 393.0 | x | 328.0     | x | 4.7 | 15.47 | x | 12.91 | x | 0.185 |
| 1015162                | FM2133          | PAPER                | 2 PASS            | 41                     | INT TH    | 125.0 | x | 68.6      | x | 3.6 | 4.92  | x | 2.7   | x | 0.142 |
| 1027179                | FM5352MP        | STEEL                | -----             | 37                     | EXT TH    | 75.5  | x | 57.2      | x | 1.1 | 2.97  | x | 2.25  | x | 0.042 |
| 1027180                | FM5349          | BRONZE               | WAFFLE            | 27                     | INT TH    | 71.1  | x | 52.7      | x | 1.7 | 2.8   | x | 2.07  | x | 0.065 |
| 1027513                | FM4953KIT       | MOLYBDENUM/STEEL     | THIN KIT          | 2 x FRICTION 2 x STEEL |           |       |   |           |   |     |       |   |       |   |       |
| 1027518                | FM4951KIT       | MOLYBDENUM/STEEL     | THICK KIT         | 2 x FRICTION 2 x STEEL |           |       |   |           |   |     |       |   |       |   |       |
| 1028458                | FM1202MP        | STEEL                | -----             | 1                      | EXT LG    | 209.3 | x | 114.3     | x | 2.7 | 8.24  | x | 4.5   | x | 0.106 |
| 1028671                | FM2751          | GRAPHITE             | SPR/RAD/WAG       | 85                     | INT TH    | 381.0 | x | 307.3     | x | 5.6 | 15    | x | 12.1  | x | 0.22  |
| 1033348                | FM2131          | PAPER                | 2 PASS            | 37                     | INT TH    | 155.7 | x | 87.9      | x | 2.6 | 6.13  | x | 3.46  | x | 0.102 |
| 1033349                | FM2124MP        | STEEL                | -----             | 6                      | EXT LG    | 169.9 | x | 100.1     | x | 2.2 | 6.69  | x | 3.94  | x | 0.087 |
| 1038580                | FM2131          | PAPER                | 2 PASS            | 37                     | INT TH    | 155.7 | x | 87.9      | x | 2.6 | 6.13  | x | 3.46  | x | 0.102 |
| 1038585                | FM2124MP        | STEEL                | -----             | 6                      | EXT LG    | 169.9 | x | 100.1     | x | 2.2 | 6.69  | x | 3.94  | x | 0.087 |
| 1043356                | FM9309KIT       | MOLYBDENUM/STEEL     | THIN KIT          | 2 x FRICTION 2 x STEEL |           |       |   |           |   |     |       |   |       |   |       |
| 1043357                | FM9307KIT       | MOLYBDENUM/STEEL     | THICK KIT         | 2 x FRICTION 2 x STEEL |           |       |   |           |   |     |       |   |       |   |       |
| 1058750                | FM6177          | CARBON PA            | 2 PASS            | 30                     | INT TH    | 324.6 | x | 112.1     | x | 7.2 | 12.78 | x | 4.42  | x | 0.283 |
| 1060477                | FM4702MP        | STEEL                | -----             | 128                    | EXT TH    | 408.9 | x | 292.1     | x | 5.5 | 16.1  | x | 11.5  | x | 0.215 |
| 1060478                | FM4699          | BRONZE               | WAFFLE            | 88                     | INT TH    | 393.7 | x | 273.3     | x | 5.6 | 15.5  | x | 10.76 | x | 0.22  |
| 1063117                | FM3308MP        | STEEL                | -----             | 64                     | EXT TH    | 479.5 | x | 342.2     | x | 3.2 | 18.88 | x | 13.47 | x | 0.126 |
| 1067438                | FM3170MP        | STEEL                | SLOTS             | 128                    | EXT TH    | 410.0 | x | 292.1     | x | 3.2 | 16.14 | x | 11.5  | x | 0.125 |
| 1076954                | FM9123          | PAPER                | 2 PASS            | 9                      | INT LG    | 165.0 | x | 129.7     | x | 3.2 | 6.5   | x | 5.11  | x | 0.124 |
| 1076955                | FM9126MP        | STEEL                | HARDENED          | 4                      | EXT LG    | 177.5 | x | 150.2     | x | 1.4 | 6.99  | x | 5.91  | x | 0.055 |
| 1085751                | FM3207          | PAPER                | 2 PASS/PLAIN      | 52                     | INT TH    | 216.0 | x | 128.0     | x | 4.0 | 8.5   | x | 5.04  | x | 0.157 |
| 1090063                | FM4702MP        | STEEL                | -----             | 128                    | EXT TH    | 408.9 | x | 292.1     | x | 5.5 | 16.1  | x | 11.5  | x | 0.215 |
| 1102631                | FM2393          | BRONZE               | SUNBURST          | 88                     | INT TH    | 393.7 | x | 273.3     | x | 4.7 | 15.5  | x | 10.76 | x | 0.185 |
| 1107723                | FM3196MP        | STEEL                | -----             | 30                     | EXT TH    | 200.0 | x | 140.0     | x | 3.0 | 7.87  | x | 5.51  | x | 0.118 |
| 1147273                | FM2124MP        | STEEL                | -----             | 6                      | EXT LG    | 169.9 | x | 100.1     | x | 2.2 | 6.69  | x | 3.94  | x | 0.087 |
| 1155571                | FM5878MP        | STEEL                | -----             | 5                      | EXT LG    | 396.0 | x | 284.0     | x | 5.0 | 15.59 | x | 11.18 | x | 0.197 |
| 1155572                | FM5880MP        | STEEL                | -----             | 5                      | EXT LG    | 396.0 | x | 284.0     | x | 5.0 | 15.59 | x | 11.18 | x | 0.197 |
| 1157261                | FM2131          | PAPER                | 2 PASS            | 37                     | INT TH    | 155.7 | x | 87.9      | x | 2.6 | 6.13  | x | 3.46  | x | 0.102 |
| 1162387                | FM8753          | BRONZE               | WAGON             | 89                     | INT TH    | 405.3 | x | 278.1     | x | 7.3 | 15.96 | x | 10.94 | x | 0.287 |
| 1163936                | FM2048MP        | STEEL                | -----             | 144                    | EXT TH    | 737.9 | x | 539.8     | x | 2.5 | 29.05 | x | 21.25 | x | 0.1   |
| 1173321                | FM4629          | PAPER                | WAFFLE            | 18                     | INT TH    | 333.0 | x | 65.3      | x | 8.4 | 13.11 | x | 2.57  | x | 0.331 |
| 1186606                | FM3678MP        | STEEL                | -----             | 6                      | EXT LG    | 356.9 | x | 166.6     | x | 6.4 | 14.05 | x | 6.56  | x | 0.25  |
| 1200843                | FM1900MP        | STEEL                | -----             | 64                     | EXT TH    | 205.5 | x | 145.3     | x | 1.7 | 8.09  | x | 5.72  | x | 0.067 |
| 1210669                | FM4799          | BRONZE               | SUNBURST          | 67                     | INT TH    | 612.4 | x | 496.6     | x | 5.6 | 24.11 | x | 19.55 | x | 0.222 |
| 1210670                | FM4804MP        | STEEL                | -----             | 84                     | EXT TH    | 627.1 | x | 509.0     | x | 6.0 | 24.69 | x | 20.04 | x | 0.236 |
| 1210677                | FM4802MP        | STEEL                | -----             | 60                     | EXT TH    | 450.3 | x | 342.1     | x | 3.2 | 17.73 | x | 13.47 | x | 0.125 |
| 1217632                | FM3575          | PAPER                | 3 PASS            | 35                     | INT TH    | 179.0 | x | 103.0     | x | 3.5 | 7.05  | x | 4.05  | x | 0.138 |

| REPLACES<br>OEM PT.NO. | FMC<br>PART NO. | MATERIAL         | GROOVE<br>DETAILS | TEETH/<br>TANGS | SIZE MM   | SIZE INCH                                  |
|------------------------|-----------------|------------------|-------------------|-----------------|-----------|--|
| 1217633                | FM3946MP        | STEEL            | -----             | 67              | (70)EX TH | 191.0 x 130.0 x 3.0 7.52 x 5.12 x 0.118    |
| 1217634                | FM3948MP        | STEEL            | -----             | 67              | (70)EX TH | 191.0 x 130.0 x 2.5 7.52 x 5.12 x 0.098    |
| 1217635                | FM4844MP        | STEEL            | -----             | 67              | (70)EX TH | 191.0 x 130.0 x 2.0 7.52 x 5.12 x 0.079    |
| 1221880                | FM3261          | PAPER            | 2 PASS            | 40              | INT TH    | 127.1 x 82.2 x 2.5 5.0 x 3.24 x 0.098      |
| 1221881                | FM3264MP        | STEEL            | -----             | 26              | EXT TH    | 143.5 x 89.5 x 2.2 5.65 x 3.52 x 0.084     |
| 1221882                | FM3902MP        | END PLATE        | -----             | 26              | EXT TH    | 143.4 x 89.5 x 10.9 5.65 x 3.52 x 0.429    |
| 1267924                | FM4827          | PAPER            | 2 PASS            | 18              | INT TH    | 299.5 x 65.3 x 7.0 11.79 x 2.57 x 0.276    |
| 1299248                | FM5110MP        | STEEL            | -----             | 64              | EXT TH    | 479.3 x 341.3 x 4.0 18.87 x 13.44 x 0.157  |
| 1305860                | FM7445          | CARBON PA        | WAFFLE            | 18              | INT TH    | 478.0 x 106.0 x 5.4 18.82 x 4.17 x 0.213   |
| 1305866                | FM4154MP        | STEEL            | -----             | 2               | EXT LG    | 562.0 x 353.5 x 8.0 22.13 x 13.92 x 0.313  |
| 1305867                | FM5148MP        | STEEL            | PISTON            |                 |           |  |
| 1337234                | FM2987          | BRONZE           | SPR/WAG           | 22              | INT TH    | 204.5 x 53.3 x 4.8 8.05 x 2.1 x 0.19       |
| 1348360                | FM7991          | PAPER            | 2 PASS            | 60              | INT TH    | 215.0 x 149.2 x 4.0 8.46 x 5.87 x 0.157    |
| 1348361                | FM7994MP        | STEEL            | -----             | 32              | EXT TH    | 224.7 x 158.0 x 4.0 8.85 x 6.22 x 0.157    |
| 1357494                | FM4953KIT       | MLYBDNM/STL      | THIN KIT          |                 |           | 2 x FRICTION 2 x STEEL                     |
| 1357495                | FM4951KIT       | MLYBDNM/STL      | THICK KIT         |                 |           | 2 x FRICTION 2 x STEEL                     |
| 1366324                | FM4577          | PAPER            | 2 PASS            | 38              | INT TH    | 225.0 x 116.0 x 3.3 8.86 x 4.57 x 0.128    |
| 1366325                | FM4593          | PAPER            | 2 PASS            | 38              | INT TH    | 265.0 x 116.0 x 3.9 10.43 x 4.57 x 0.154   |
| 1368064                | FM5493          | BRONZE           | WAFFLE            | 28              | INT TH    | 102.0 x 55.5 x 1.8 4.02 x 2.19 x 0.071     |
| 1368068                | FM5496MP        | STEEL            | -----             | 3               | EXT LG    | 115.0 x 65.0 x 1.5 4.53 x 2.56 x 0.059     |
| 1371620                | FM7996MP        | STEEL            | -----             | 5               | EXT LG    | 360.0 x 263.3 x 4.0 14.17 x 10.37 x 0.157  |
| 1400262                | FM4533          | MOLYBDENUM       | SPR/RAD           | 44              | INT TH    | 191.3 x 94.2 x 4.1 7.53 x 3.71 x 0.161     |
| 1402371                | FM8119          | PAPER            | 2 PASS            | 101             | INT TH    | 311.2 x 253.0 x 5.2 12.25 x 9.96 x 0.204   |
| 1407160                | FM8348MP        | STEEL            | END PLATE         | 6               | EXT LG    | 625.3 x 454.0 x 6.4 24.62 x 17.87 x 0.252  |
| 1444468                | FM9309KIT       | MOLYBDENUM/STEEL | THIN KIT          |                 |           | 2 x FRICTION 2 x STEEL                     |
| 1444470                | FM9307KIT       | MOLYBDENUM/STEEL | THICK KIT         |                 |           | 2 x FRICTION 2 x STEEL                     |
| 1455189                | FM7560MP        | STEEL            | -----             | 214             | EXT TH    | 1094.0 x 837.0 x 4.0 43.07 x 32.95 x 0.157 |
| 1455192                | FM7561          | CORK             | -----             | 214             | EXT TH    | 1094.0 x 837.0 x 8.5 43.07 x 32.95 x 0.335 |
| 1457001                | FM7196MP        | STEEL            | -----             | 16              | (24)EX TH | 257.2 x 190.6 x 1.9 10.13 x 7.5 x 0.075    |
| 1518274                | FM4590MP        | STEEL            | -----             | 9               | EXT SL    | 256.0 x 168.0 x 2.0 10.08 x 6.61 x 0.077   |
| 1518275                | FM4592MP        | STEEL            | END PLATE         | 9               | EXT SL    | 256.0 x 168.0 x 5.0 10.08 x 6.61 x 0.197   |
| 1518281                | FM4598MP        | STEEL            | END PLATE         | 10              | EXT SL    | 297.0 x 190.0 x 6.0 11.69 x 7.48 x 0.236   |
| 1518282                | FM4596MP        | STEEL            | -----             | 10              | EXT SL    | 297.0 x 190.0 x 2.0 11.69 x 7.48 x 0.077   |
| 1545613                | FM8040MP        | STEEL            | -----             | 5               | EXT LG    | 385.5 x 283.8 x 5.0 15.18 x 11.17 x 0.197  |
| 1578412                | FM8037          | CARBON PA        | 2 PASS            | 75              | INT TH    | 345.0 x 271.1 x 5.6 13.58 x 10.67 x 0.22   |
| 1583750                | FM4157          | ELASTOMER        | SPR/RAD/WAG       | 80              | INT TH    | 432.1 x 337.8 x 5.6 17.01 x 13.3 x 0.22    |
| ALTERNATIVE            | FM6283          | CARBON           | WAFFLE            | 80              | INT TH    | 432.1 x 337.8 x 5.6 17.01 x 13.3 x 0.22    |
| 1583752                | FM2979          | GRAPHITE         | SPR/RAD/WAG       | 138             | INT TH    | 533.4 x 435.1 x 5.6 21.0 x 17.13 x 0.22    |
| 1590927                | FM4693          | PAPER            | 2 PASS/PLAIN      | 52              | INT TH    | 190.0 x 128.6 x 3.0 7.48 x 5.06 x 0.118    |
| 1630342                | FM3201          | PAPER            | 2 PASS            | 52              | INT TH    | 160.0 x 108.0 x 4.0 6.3 x 4.25 x 0.157     |
| 1630343                | FM3199          | PAPER            | 2 PASS            | 52              | INT TH    | 190.0 x 128.0 x 4.0 7.48 x 5.04 x 0.157    |
| 1638838                | FM3831          | PAPER            | 2 PASS            | 56              | EXT TH    | 239.0 x 157.0 x 4.0 9.41 x 6.18 x 0.157    |
| 1639366                | FM2048MP        | STEEL            | -----             | 144             | EXT TH    | 737.9 x 539.8 x 2.5 29.05 x 21.25 x 0.1    |
| 1644221                | FM7997          | CARBON PA        | 3 PASS            | 108             | INT TH    | 409.6 x 337.6 x 5.6 16.13 x 13.29 x 0.22   |
| 1657067                | FM2777          | GRAPHITE         | SUNBURST          | 27              | INT TH    | 260.0 x 66.1 x 10.0 10.24 x 2.6 x 0.394    |
| 1671261                | FM6703          | CORK             | -----             | 6               | EXT LG    | 356.8 x 185.4 x 10.8 14.05 x 7.3 x 0.425   |
| 1697055                | FM2127          | GRAPHITE         | SPR/RAD/WAG       | 80              | INT TH    | 432.1 x 337.8 x 5.6 17.01 x 13.3 x 0.22    |

| REPLACES<br>OEM PT.NO. | FMC<br>PART NO. | MATERIAL  | GROOVE<br>DETAILS | TEETH/<br>TANGS | SIZE MM   |       |   | SIZE INCH |   |      |       |   |       |   |       |
|------------------------|-----------------|-----------|-------------------|-----------------|-----------|-------|---|-----------|---|------|-------|---|-------|---|-------|
| 1698398                | FM7038MP        | STEEL     | HARD/BLACK        | 64              | EXT TH    | 196.4 | x | 140.0     | x | 2.9  | 7.73  | x | 5.51  | x | 0.114 |
| 1701208                | FM7447          | CARBON PA | 2 PASS            | 18              | INT TH    | 298.0 | x | 65.3      | x | 7.8  | 11.73 | x | 2.57  | x | 0.307 |
| 1702108                | FM1967          | PAPER     | 2 PASS            | 101             | INT TH    | 311.2 | x | 253.0     | x | 5.1  | 12.25 | x | 9.96  | x | 0.2   |
| 1708714                | FM3831          | PAPER     | 2 PASS            | 56              | EXT TH    | 239.0 | x | 157.0     | x | 4.0  | 9.41  | x | 6.18  | x | 0.157 |
| 1720844                | FM5492MP        | STEEL     | -----             | 4               | EXT LG    | 379.2 | x | 209.5     | x | 6.7  | 14.93 | x | 8.25  | x | 0.266 |
| 1733270                | FM4157          | ELASTOMER | SPR/RAD/WAG       | 80              | INT TH    | 432.1 | x | 337.8     | x | 5.6  | 17.01 | x | 13.3  | x | 0.22  |
| ALTERNATIVE            | FM6283          | CARBON    | WAFFLE            | 80              | INT TH    | 432.1 | x | 337.8     | x | 5.6  | 17.01 | x | 13.3  | x | 0.22  |
| 1733271                | FM4667          | ELASTOMER | SPR/RAD/WAG       | 138             | INT TH    | 533.4 | x | 435.1     | x | 5.6  | 21.0  | x | 17.13 | x | 0.22  |
| ALTERNATIVE            | FM6767          | CARBON    | WAFFLE            | 138             | INT TH    | 533.4 | x | 435.1     | x | 5.6  | 21.0  | x | 17.13 | x | 0.22  |
| 1733272                | FM9151          | ELASTOMER | SPR/RAD/WAG       | 138             | INT TH    | 556.8 | x | 435.1     | x | 5.6  | 21.92 | x | 17.13 | x | 0.22  |
| ALTERNATIVE            | FM7001          | CARBON    | WAFFLE            | 138             | INT TH    | 556.8 | x | 435.1     | x | 5.6  | 21.92 | x | 17.13 | x | 0.22  |
| 1733450                | FM7093          | PAPER     | 2 PASS            | 43              | INT TH    | 155.0 | x | 129.4     | x | 2.0  | 6.1   | x | 5.09  | x | 0.079 |
| 1733451                | FM7096MP        | STEEL     | -----             | 8               | EXT LG    | 163.7 | x | 139.0     | x | 1.7  | 6.44  | x | 5.47  | x | 0.067 |
| 1843677                | FM6164MP        | STEEL     | -----             | 4               | EXT LG    | 351.8 | x | 209.9     | x | 6.4  | 13.85 | x | 8.26  | x | 0.252 |
| 1903532                | FM4925          | AFP       | 3 PASS            | 120             | INT TH    | 874.5 | x | 603.0     | x | 5.1  | 34.43 | x | 23.74 | x | 0.2   |
| 1943811                | FM4156MP        | STEEL     | -----             | 6               | EXT LG    | 605.0 | x | 438.0     | x | 6.4  | 23.82 | x | 17.24 | x | 0.25  |
| 1953722                | FM6702MP        | STEEL     | -----             | 6               | EXT LG    | 356.8 | x | 166.6     | x | 3.2  | 14.05 | x | 6.56  | x | 0.126 |
| 1967866                | FM4863          | AFP       | 3 PASS            | 102             | INT TH    | 715.3 | x | 511.3     | x | 5.1  | 28.16 | x | 20.13 | x | 0.2   |
| 1967866                | FM9007          | CARBON PA | 3 PASS            | 102             | INT TH    | 715.3 | x | 511.3     | x | 5.1  | 28.16 | x | 20.13 | x | 0.2   |
| 1981137                | FM4113          | PAPER     | 3 PASS            | 102             | INT TH    | 874.5 | x | 635.6     | x | 5.1  | 34.43 | x | 25.03 | x | 0.2   |
| 1981202                | FM7567          | CORK      | -----             | 189             | EXT TH    | 967.0 | x | 744.0     | x | 7.3  | 38.07 | x | 29.29 | x | 0.287 |
| 1981203                | FM7566MP        | STEEL     | -----             | 189             | EXT TH    | 967.0 | x | 744.0     | x | 2.7  | 38.07 | x | 29.29 | x | 0.106 |
| 1990750                | FM9421          | PAPER     | WAFFLE            | 55              | INT TH    | 260.0 | x | 164.2     | x | 4.0  | 10.24 | x | 6.46  | x | 0.157 |
| 1990786                | FM6720MP        | STEEL     | -----             | 3               | EXT LG    | 302.6 | x | 178.2     | x | 6.0  | 11.91 | x | 7.02  | x | 0.236 |
| 2010737                | FM6177          | CARBON PA | 2 PASS            | 30              | INT TH    | 324.6 | x | 112.1     | x | 7.1  | 12.78 | x | 4.42  | x | 0.28  |
| 2043091                | FM3414MP        | END PLATE | -----             | 32              | (64)EX TH | 230.0 | x | 152.5     | x | 10.8 | 9.06  | x | 6.0   | x | 0.397 |
| 2043092                | FM7337          | PAPER     | 2 PASS            | 36              | INT TH    | 223.0 | x | 71.0      | x | 4.9  | 8.78  | x | 2.8   | x | 0.191 |
| 2043093                | FM3912MP        | END PLATE | -----             | 64              | EXT TH    | 230.0 | x | 152.5     | x | 5.0  | 9.06  | x | 6.0   | x | 0.197 |
| 2071266                | FM7563          | AFP       | 3 PASS            | 111             | INT TH    | 939.4 | x | 693.0     | x | 5.1  | 36.98 | x | 27.28 | x | 0.201 |
| 2087905                | FM2971          | BRONZE    | WAFFLE            | 22              | INT TH    | 71.7  | x | 44.0      | x | 2.8  | 2.82  | x | 1.73  | x | 0.11  |
| 2087906                | FM2969          | BRONZE    | WAFFLE            | 22              | INT TH    | 71.7  | x | 44.0      | x | 1.6  | 2.82  | x | 1.73  | x | 0.063 |
| 2087907                | FM3474MP        | STEEL     | -----             | 4               | EXT LG    | 85.0  | x | 49.2      | x | 1.5  | 3.35  | x | 1.94  | x | 0.059 |
| 20R2819                | FM2168MP        | STEEL     | -----             | 6               | EXT LG    | 336.0 | x | 233.4     | x | 3.2  | 13.23 | x | 9.19  | x | 0.125 |
| 2137928                | FM9271          | CARBON PA | WAFFLE            | 30              | INT TH    | 355.0 | x | 112.0     | x | 6.1  | 13.98 | x | 4.41  | x | 0.24  |
| 2158140                | FM4699          | BRONZE    | WAFFLE            | 88              | INT TH    | 393.7 | x | 273.3     | x | 5.6  | 15.5  | x | 10.76 | x | 0.22  |
| 2172895                | FM7337          | PAPER     | 2 PASS            | 36              | INT TH    | 223.0 | x | 71.0      | x | 4.9  | 8.78  | x | 2.8   | x | 0.191 |
| 2174541                | FM7973          | PAPER     | 2 PASS            | 57              | INT TH    | 239.7 | x | 178.3     | x | 2.9  | 9.44  | x | 7.02  | x | 0.114 |
| 2180268                | FM9274MP        | STEEL     | -----             | 3               | EXT LG    | 411.0 | x | 251.5     | x | 6.4  | 16.18 | x | 9.9   | x | 0.25  |
| 2200189                | FM7445          | CARBON PA | WAFFLE            | 18              | INT TH    | 478.8 | x | 106.0     | x | 5.4  | 18.85 | x | 4.17  | x | 0.213 |
| 2200190                | FM7303          | CARBON PA | WAFFLE            | 62              | INT TH    | 462.0 | x | 192.0     | x | 6.2  | 18.19 | x | 7.56  | x | 0.244 |
| 2210775                | FM7317          | AFP       | 3 PASS            | 80              | INT TH    | 540.0 | x | 400.0     | x | 5.1  | 21.26 | x | 15.74 | x | 0.2   |
| 2210775                | FM9005          | CARBON PA | 3 PASS            | 80              | INT TH    | 540.0 | x | 400.0     | x | 5.1  | 21.26 | x | 15.74 | x | 0.2   |
| 2219685                | FM2245          | GRAPHITE  | SPR/RAD           | 75              | INT TH    | 344.9 | x | 271.0     | x | 5.6  | 13.58 | x | 10.67 | x | 0.222 |
| 2222333                | FM4921          | AFP       | 3 PASS            | 62              | INT TH    | 495.3 | x | 308.1     | x | 5.1  | 19.5  | x | 12.13 | x | 0.2   |
| 2222826                | FM4927          | AFP       | 3 PASS            | 102             | INT TH    | 874.5 | x | 635.6     | x | 5.1  | 34.43 | x | 25.03 | x | 0.2   |
| 2222826                | FM8179          | CARBON PA | 3 PASS            | 102             | INT TH    | 874.5 | x | 635.6     | x | 5.1  | 34.43 | x | 25.03 | x | 0.2   |
| 2225203                | FM8119          | PAPER     | 2 PASS            | 101             | INT TH    | 311.2 | x | 253.0     | x | 5.2  | 12.25 | x | 9.96  | x | 0.204 |
| 2234311                | FM2823          | PAPER     | 2 PASS            | 36              | INT TH    | 223.0 | x | 71.0      | x | 4.9  | 8.78  | x | 2.8   | x | 0.191 |

| REPLACES<br>OEM PT.NO. | FMC<br>PART NO. | MATERIAL  | GROOVE<br>DETAILS | TEETH/<br>TANGS | SIZE MM    |        |   | SIZE INCH |   |     |       |   |       |   |       |
|------------------------|-----------------|-----------|-------------------|-----------------|------------|--------|---|-----------|---|-----|-------|---|-------|---|-------|
| 2237519                | FM7991          | PAPER     | 2 PASS            | 60              | INT TH     | 215.0  | x | 149.2     | x | 4.0 | 8.46  | x | 5.87  | x | 0.157 |
| 2262826                | FM4927          | AFP       | 3 PASS            | 102             | INT TH     | 874.5  | x | 635.6     | x | 5.1 | 34.43 | x | 25.03 | x | 0.2   |
| 2262826                | FM8179          | CARBON PA | 3 PASS            | 102             | INT TH     | 874.5  | x | 635.6     | x | 5.1 | 34.43 | x | 25.03 | x | 0.2   |
| 2304017                | FM3035          | PAPER     | WAFFLE            | 22              | INT TH     | 204.5  | x | 53.3      | x | 4.8 | 8.05  | x | 2.1   | x | 0.189 |
| 2312236                | FM3249          | ELASTOMER | SPR/RAD           | 52              | INT TH     | 160.0  | x | 108.0     | x | 4.0 | 6.3   | x | 4.25  | x | 0.157 |
| 2327575                | FM9500MP        | END PLATE | -----             | 6               | EXT LG     | 482.5  | x | 355.5     | x | 6.4 | 19.0  | x | 14.0  | x | 0.252 |
| 2339748                | FM6913          | CARBON PA | 2 PASS            | 80              | INT TH     | 431.0  | x | 337.8     | x | 5.6 | 16.97 | x | 13.3  | x | 0.22  |
| 2346707                | FM6965          | CARBON PA | 2 PASS            | 65              | INT TH     | 283.3  | x | 204.2     | x | 5.0 | 11.15 | x | 8.04  | x | 0.197 |
| 2368675                | FM6687          | BRONZE    | RADIAL            | 62              | INT TH     | 311.2  | x | 192.9     | x | 5.0 | 12.25 | x | 7.59  | x | 0.197 |
| 2381867                | FM7406MP        | STEEL     | -----             | 6               | EXT LG     | 466.8  | x | 355.7     | x | 6.8 | 18.38 | x | 14.0  | x | 0.266 |
| 2383309                | FM7132-2.5      | STEEL     | -----             | 36              | (48)INT TH | 236.0  | x | 144.2     | x | 2.5 | 9.29  | x | 5.68  | x | 0.098 |
| 2384684                | FM8049          | BRONZE    | WAF/WAG           | 34              | INT TH     | 104.0  | x | 68.0      | x | 1.6 | 4.09  | x | 2.68  | x | 0.063 |
| 2384686                | FM8188MP        | STEEL     | HARDENED          | 45              | EXT TH     | 111.2  | x | 84.2      | x | 1.4 | 4.38  | x | 3.31  | x | 0.055 |
| 2385291                | FM6717          | PAPER     | WAFFLE            | 29              | INT TH     | 259.0  | x | 85.0      | x | 4.0 | 10.2  | x | 3.35  | x | 0.157 |
| 2399956                | FM2987          | BRONZE    | SPR/WAG           | 22              | INT TH     | 204.5  | x | 53.3      | x | 4.8 | 8.05  | x | 2.1   | x | 0.19  |
| 2414890                | FM2979          | GRAPHITE  | SPR/RAD/WAG       | 138             | INT TH     | 533.4  | x | 435.1     | x | 5.6 | 21    | x | 17.13 | x | 0.22  |
| 2418470                | FM9018MP        | STEEL     | -----             | 128             | EXT TH     | 409.4  | x | 292.5     | x | 7.3 | 16.12 | x | 11.52 | x | 0.287 |
| 2468779                | FM8155          | PAPER     | 2 PASS            | 61              | INT TH     | 324.2  | x | 220.3     | x | 5.0 | 17.76 | x | 8.67  | x | 0.197 |
| 2468780                | FM8158MP        | STEEL     | -----             | 3               | EXT LG     | 370.0  | x | 234.0     | x | 6.3 | 14.57 | x | 9.21  | x | 0.248 |
| 2482226                | FM8380MP        | STEEL     | -----             | 32              | EXT TH     | 224.8  | x | 138.3     | x | 4.0 | 8.85  | x | 5.44  | x | 0.157 |
| 2501844                | FM7447          | CARBON PA | 2 PASS            | 18              | INT TH     | 298.0  | x | 65.3      | x | 7.8 | 11.73 | x | 2.57  | x | 0.307 |
| 2501845                | FM8207          | CARBON PA | WAFFLE            | 18              | INT TH     | 333.0  | x | 65.5      | x | 9.1 | 13.11 | x | 2.58  | x | 0.358 |
| 2559265                | FM5141          | PAPER     | SUNBURST          | 104             | INT TH     | 440.0  | x | 326.0     | x | 4.8 | 17.32 | x | 12.83 | x | 0.189 |
| 2559267                | FM6651          | PAPER     | SUNBURST          | 88              | INT TH     | 393.7  | x | 273.3     | x | 4.7 | 15.5  | x | 10.76 | x | 0.185 |
| 2559268                | FM2409          | PAPER     | SUNBURST          | 120             | EXT TH     | 384.6  | x | 291.3     | x | 4.6 | 15.14 | x | 11.47 | x | 0.18  |
| 2596836                | FM6665          | PAPER     | 2 PASS            | 36              | INT TH     | 356.0  | x | 135.0     | x | 3.6 | 14.02 | x | 5.31  | x | 0.142 |
| 2627319                | FM2127          | GRAPHITE  | SPR/RAD/WAG       | 80              | INT TH     | 432.1  | x | 337.8     | x | 5.6 | 17.01 | x | 13.3  | x | 0.22  |
| 2627320                | FM9167          | GRAPHITE  | SPR/RAD/WAG       | 138             | INT TH     | 553.6  | x | 436.9     | x | 5.6 | 21.8  | x | 17.2  | x | 0.22  |
| 2633704                | FM6715          | CARBON PA | WAFFLE            | 8               | EXT LG     | 262.7  | x | 155.0     | x | 4.5 | 10.34 | x | 6.1   | x | 0.177 |
| 2679169                | FM8432-2.0      | STEEL     | -----             | 31              | (40)INT TH | 208.0  | x | 119.0     | x | 2.0 | 8.19  | x | 4.69  | x | 0.079 |
| 2679170                | FM8432-2.5      | STEEL     | -----             | 31              | (40)INT TH | 208.0  | x | 119.0     | x | 2.5 | 8.19  | x | 4.69  | x | 0.098 |
| 2679171                | FM8432-3.0      | STEEL     | -----             | 31              | (40)INT TH | 208.0  | x | 119.0     | x | 3.0 | 8.19  | x | 4.69  | x | 0.118 |
| 2701778                | FM7976MP        | STEEL     | -----             | 9               | EXT TH     | 276.4  | x | 188.0     | x | 2.5 | 10.88 | x | 7.4   | x | 0.098 |
| 2709292                | FM6211          | PAPER     | 3 PASS            | 81              | INT TH     | 715.3  | x | 503.0     | x | 5.1 | 28.16 | x | 19.8  | x | 0.201 |
| 2760017                | FM7996MP        | STEEL     | -----             | 5               | EXT LG     | 360.0  | x | 263.3     | x | 4.0 | 14.17 | x | 10.37 | x | 0.157 |
| 2744553                | FM1324MP        | STEEL     | -----             | 54              | EXT TH     | 139.2  | x | 98.6      | x | 1.8 | 5.48  | x | 3.88  | x | 0.07  |
| 2849557                | FM6668MP        | STEEL     | -----             | 4               | EXT LG     | 438.8  | x | 252.1     | x | 1.9 | 17.28 | x | 9.93  | x | 0.075 |
| 2864365                | FM6883          | CARBON PA | 2 PASS            | 114             | INT TH     | 412.0  | x | 286.0     | x | 4.8 | 16.22 | x | 11.26 | x | 0.189 |
| 2893614                | FM8607          | CARBON    | WAFFLE            | 124             | INT TH     | 482.6  | x | 388.4     | x | 5.6 | 19.0  | x | 15.29 | x | 0.22  |
| 2912901                | FM7259          | AFP       | 3 PASS            | 81              | INT TH     | 715.3  | x | 503.0     | x | 5.1 | 28.16 | x | 19.8  | x | 0.201 |
| 2912902                | FM7653          | CARBON PA | 4 PASS            | 128             | INT TH     | 1067.0 | x | 800.0     | x | 6.0 | 42.0  | x | 31.5  | x | 0.236 |
| 2974956                | FM9015          | CARBON PA | WAFFLE            | 88              | INT TH     | 393.0  | x | 273.6     | x | 4.7 | 15.47 | x | 10.77 | x | 0.185 |
| 2977231C               | FM6476MP        | STEEL     | -----             | 6               | EXT LG     | 333.5  | x | 237.0     | x | 3.2 | 13.13 | x | 9.33  | x | 0.126 |
| 3013676                | FM8037          | CARBON PA | 2 PASS            | 75              | INT TH     | 345.0  | x | 271.1     | x | 5.6 | 13.58 | x | 10.67 | x | 0.22  |
| 3022705C               | FM1420MP        | STEEL     | -----             | 8               | INT LG     | 368.3  | x | 273.1     | x | 2.3 | 14.5  | x | 10.75 | x | 0.09  |
| 3022712C               | FM1908MP        | STEEL     | -----             | 5               | EXT LG     | 411.5  | x | 317.5     | x | 6.4 | 16.2  | x | 12.5  | x | 0.25  |
| 3154128                | FM9275          | CARBON PA | WAFFLE            | 96              | INT TH     | 348.0  | x | 240.8     | x | 4.9 | 13.7  | x | 9.48  | x | 0.191 |

| REPLACES<br>OEM PT.NO. | FMC<br>PART NO. | MATERIAL  | GROOVE<br>DETAILS | TEETH/<br>TANGS | SIZE MM   |        |   | SIZE INCH |   |      |       |   |       |   |       |
|------------------------|-----------------|-----------|-------------------|-----------------|-----------|--------|---|-----------|---|------|-------|---|-------|---|-------|
| 3167320                | FM2823          | PAPER     | 2 PASS            | 36              | INT TH    | 223.0  | x | 71.0      | x | 4.9  | 8.78  | x | 2.8   | x | 0.191 |
| 3167330                | FM3912MP        | END PLATE | -----             | 64              | EXT TH    | 230.0  | x | 152.5     | x | 5.0  | 9.06  | x | 6     | x | 0.197 |
| 3207379                | FM3414MP        | END PLATE | -----             | 32              | (64)EX TH | 230.0  | x | 152.5     | x | 10.8 | 9.06  | x | 6     | x | 0.397 |
| 3217367                | FM8546MP        | STEEL     | -----             | 94              | EXT TH    | 301.0  | x | 227.0     | x | 3.2  | 11.85 | x | 8.94  | x | 0.126 |
| 3222250                | FM2781          | GRAPHITE  | SUNBURST          | 15              | INT TH    | 213.0  | x | 44.0      | x | 10.0 | 8.38  | x | 1.73  | x | 0.394 |
| 3232945                | FM9278MP        | STEEL     | -----             | 141             | EXT TH    | 362.0  | x | 254.0     | x | 3.5  | 14.25 | x | 10.0  | x | 0.136 |
| 3256166C               | FM1488MP        | STEEL     | -----             | 56              | INT TH    | 268.0  | x | 173.5     | x | 3.2  | 10.55 | x | 6.83  | x | 0.126 |
| 3256167C               | FM1890MP        | STEEL     | -----             | 72              | EXT TH    | 369.8  | x | 222.3     | x | 6.4  | 14.56 | x | 8.75  | x | 0.25  |
| 3256168C               | FM2312MP        | STEEL     | -----             | 128             | EXT LG    | 410.0  | x | 292.1     | x | 2.3  | 16.14 | x | 11.5  | x | 0.09  |
| 3256170C               | FM2312MP        | STEEL     | -----             | 128             | EXT LG    | 410.0  | x | 292.1     | x | 2.3  | 16.14 | x | 11.5  | x | 0.09  |
| 3256171C               | FM3166MP        | STEEL     | -----             | 4               | EXT LG    | 329.0  | x | 186.0     | x | 5.0  | 12.95 | x | 7.32  | x | 0.197 |
| 3256172C               | FM2940MP        | STEEL     | -----             | 4               | EXT LG    | 284.0  | x | 146.0     | x | 3.2  | 11.18 | x | 5.75  | x | 0.126 |
| 3284374                | FM2243          | PAPER     | SPR/RAD           | 75              | INT TH    | 344.9  | x | 271.0     | x | 5.6  | 13.58 | x | 10.67 | x | 0.222 |
| 3284375                | FM2249          | PAPER     | 2 PASS            | 48              | INT TH    | 240.0  | x | 172.7     | x | 5.1  | 9.45  | x | 6.8   | x | 0.2   |
| 3341031                | FM9271          | CARBON PA | WAFFLE            | 30              | INT TH    | 355.0  | x | 112.0     | x | 6.1  | 13.98 | x | 4.41  | x | 0.24  |
| 3341032                | FM6963          | CARBON PA | WAFFLE            | 18              | INT TH    | 422.0  | x | 88.0      | x | 9.1  | 16.61 | x | 3.46  | x | 0.358 |
| 3341033                | FM7379          | CARBON PA | WAFFLE            | 18              | INT TH    | 379.1  | x | 79.2      | x | 9.1  | 14.93 | x | 3.12  | x | 0.358 |
| 3341034                | FM7381          | CARBON PA | WAFFLE            | 18              | INT TH    | 401.4  | x | 83.1      | x | 9.1  | 15.8  | x | 3.27  | x | 0.358 |
| 3347845                | FM8876MP        | STEEL     | END PLATE         | 6               | EXT LG    | 626.7  | x | 454.9     | x | 6.4  | 24.67 | x | 17.91 | x | 0.252 |
| 3353094                | FM8742MP        | STEEL     | -----             | 6               | EXT LG    | 561.7  | x | 406.5     | x | 6.8  | 22.11 | x | 16.0  | x | 0.268 |
| 3369313                | FM3303          | BRONZE    | 3 PASS            | 96              | INT TH    | 347.7  | x | 240.0     | x | 4.9  | 13.69 | x | 9.45  | x | 0.191 |
| 3369314                | FM7997          | CARBON PA | 3 PASS            | 108             | INT TH    | 409.6  | x | 337.6     | x | 5.6  | 16.13 | x | 13.29 | x | 0.22  |
| 3369315                | FM7939          | CARBON PA | 3 PASS            | 101             | INT TH    | 533.2  | x | 418.3     | x | 5.6  | 20.99 | x | 16.47 | x | 0.22  |
| 3369318                | FM6883          | CARBON PA | 2 PASS            | 114             | INT TH    | 412.0  | x | 286.0     | x | 4.8  | 16.22 | x | 11.26 | x | 0.189 |
| 3373942                | FM6703          | CORK      | -----             | 6               | EXT LG    | 356.8  | x | 185.4     | x | 10.8 | 14.05 | x | 7.3   | x | 0.425 |
| 3376800                | FM2127          | GRAPHITE  | SPR/RAD/WAG       | 80              | INT TH    | 432.1  | x | 337.8     | x | 5.6  | 17.01 | x | 13.3  | x | 0.22  |
| 3376801                | FM2755          | GRAPHITE  | SPR/RAD/WAG       | 124             | INT TH    | 482.6  | x | 388.4     | x | 5.6  | 19.0  | x | 15.29 | x | 0.22  |
| 3393206                | FM8753          | BRONZE    | WAGON             | 89              | INT TH    | 405.3  | x | 278.1     | x | 7.3  | 15.96 | x | 10.94 | x | 0.287 |
| 3438739                | FM8155          | PAPER     | 2 PASS            | 61              | INT TH    | 324.2  | x | 220.3     | x | 5.0  | 17.76 | x | 8.67  | x | 0.197 |
| 3465691C               | FM1202MP        | STEEL     | -----             | 1               | EXT LG    | 209.3  | x | 114.3     | x | 2.7  | 8.24  | x | 4.5   | x | 0.106 |
| 3465693C               | FM2987          | BRONZE    | SPR/WAG           | 22              | INT TH    | 204.5  | x | 53.3      | x | 4.8  | 8.05  | x | 2.1   | x | 0.19  |
| 3470475C               | FM3264MP        | STEEL     | -----             | 26              | EXT TH    | 143.5  | x | 89.5      | x | 2.2  | 5.65  | x | 3.52  | x | 0.084 |
| 3470485C               | FM2987          | BRONZE    | SPR/WAG           | 22              | INT TH    | 204.5  | x | 53.3      | x | 4.8  | 8.05  | x | 2.1   | x | 0.19  |
| 3510925                | FM6665          | PAPER     | 2 PASS            | 36              | INT TH    | 356.0  | x | 135.0     | x | 3.6  | 14.02 | x | 5.31  | x | 0.142 |
| 3558990                | FM4593          | PAPER     | 2 PASS            | 38              | INT TH    | 265.0  | x | 116.0     | x | 3.9  | 10.43 | x | 4.57  | x | 0.154 |
| 3570450                | FM3229          | PAPER     | 2 PASS            | 45              | INT TH    | 133.0  | x | 93.0      | x | 4.0  | 5.24  | x | 3.66  | x | 0.157 |
| 3662523                | FM8790MP        | STEEL     | -----             | 110             | EXT TH    | 566.0  | x | 426.0     | x | 3.7  | 22.28 | x | 16.77 | x | 0.146 |
| 3676070C               | FM1456MP        | STEEL     | -----             | 132             | EXT TH    | 422.7  | x | 302.5     | x | 2.3  | 16.64 | x | 11.91 | x | 0.091 |
| 3676071C               | FM1532MP        | STEEL     | -----             | 5               | EXT LG    | 353.1  | x | 263.1     | x | 6.4  | 13.9  | x | 10.36 | x | 0.25  |
| 3680297                | FM8218MP        | STEEL     | -----             | 5               | EXT LG    | 425.0  | x | 318.0     | x | 6.4  | 16.73 | x | 8.58  | x | 0.25  |
| 3708590R               | FM7406MP        | STEEL     | -----             | 6               | EXT LG    | 466.8  | x | 355.7     | x | 6.8  | 18.38 | x | 14.0  | x | 0.266 |
| 3708592R               | FM2426MP        | STEEL     | -----             | 40              | EXT TH    | 297.9  | x | 223.3     | x | 3.2  | 11.73 | x | 8.79  | x | 0.125 |
| 3744676C               | FM3257          | PAPER     | WAFFLE            | 18              | INT TH    | 110.0  | x | 54.0      | x | 5.2  | 4.33  | x | 2.13  | x | 0.205 |
| 3744677C               | FM3085          | PAPER     | 2 PASS            | 24              | INT TH    | 177.6  | x | 73.3      | x | 5.2  | 6.99  | x | 2.88  | x | 0.205 |
| 3777404C               | FM2652MP        | STEEL     | -----             | 6               | EXT LG    | 343.0  | x | 210.0     | x | 6.4  | 13.5  | x | 8.27  | x | 0.25  |
| 3777423C               | FM2426MP        | STEEL     | -----             | 40              | EXT TH    | 297.9  | x | 223.3     | x | 3.2  | 11.73 | x | 8.79  | x | 0.125 |
| 3781879                | FM9057          | CARBON PA | 3 PASS            | 68              | INT TH    | 462.5  | x | 340.5     | x | 5.1  | 18.21 | x | 13.4  | x | 0.2   |
| 3781880                | FM8177          | AFP       | 4 PASS            | 153             | INT TH    | 1010.4 | x | 768.4     | x | 5.1  | 39.78 | x | 30.25 | x | 0.2   |

| REPLACES<br>OEM PT.NO. | FMC<br>PART NO. | MATERIAL  | GROOVE<br>DETAILS | TEETH/<br>TANGS | SIZE MM     | SIZE INCH                                 |
|------------------------|-----------------|-----------|-------------------|-----------------|-------------|---|
| 3791820                | FM7923          | CORK      | -----             | 136             | (144)EX TH  | 739.1 x 539.8 x 6.9 29.1 x 21.25 x 0.271  |
| 3791822                | FM7922MP        | STEEL     | -----             | 136             | (144)EX TH  | 739.1 x 539.8 x 2.5 29.1 x 21.25 x 0.096  |
| 3801493C               | FM2412MP        | STEEL     | -----             | 6               | EXT LG      | 235.0 x 178.3 x 3.2 9.25 x 7.02 x 0.125   |
| 3807473C               | FM2881          | PAPER     | 3 PASS            | 58              | INT TH      | 266.2 x 181.6 x 4.8 10.48 x 7.15 x 0.19   |
| 3807489C               | FM1745          | CORK      | SPIRAL            | 64              | INT TH      | 381.0 x 197.6 x 5.5 15.0 x 7.78 x 0.215   |
| 3807516C               | FM4499          | PAPER     | RAD/WAG           | 104             | INT TH      | 393.0 x 328.0 x 4.7 15.47 x 12.91 x 0.185 |
| 3813629                | FM7653          | CARBON PA | 4 PASS            | 128             | INT TH      | 1067.0 x 800.0 x 6.0 42 x 31.5 x 0.236    |
| 3826889C               | FM1784MP        | STEEL     | -----             | 102             | EXT TH      | 327.9 x 209.4 x 6.4 12.89 x 8.24 x 0.251  |
| 3832119C               | FM1534MP        | STEEL     | -----             | 32              | EXT LG      | 224.8 x 177.8 x 4.8 8.85 x 7.0 x 0.189    |
| 3832121C               | FM1825          | PAPER     | 2 PASS            | 54              | INT TH      | 215.0 x 168.4 x 2.9 8.46 x 6.63 x 0.116   |
| 3832734                | FM7919          | PAPER     | 3 PASS            | 90              | (102)INT TH | 715.0 x 511.0 x 5.1 28.15 x 20.12 x 0.2   |
| 3832735                | FM7925          | CARBON PA | 3 PASS            | 90              | (102)INT TH | 715.0 x 511.0 x 5.1 28.15 x 20.12 x 0.2   |
| 3844791C               | FM3077          | CARBON PA | SPR/RAD           | 12              | EXT LG      | 361.9 x 241.6 x 6.2 14.25 x 9.51 x 0.242  |
| 3844801C               | FM2791          | PAPER     | SUNBURST          | 88              | INT TH      | 393.7 x 273.4 x 4.7 15.5 x 10.76 x 0.185  |
| 3844827C               | FM1451          | PAPER     | 2 PASS            | 87              | EXT TH      | 277.9 x 209.6 x 5.0 10.94 x 8.25 x 0.196  |
| 3845966C               | FM2243          | PAPER     | SPR/RAD           | 75              | INT TH      | 344.9 x 271.0 x 5.6 13.58 x 10.67 x 0.222 |
| 3856116C               | FM2248MP        | STEEL     | -----             | 5               | EXT LG      | 380.0 x 284.0 x 5.0 14.96 x 11.18 x 0.197 |
| 3905264C               | FM1879          | PAPER     | 2 PASS            | 95              | EXT TH      | 304.8 x 212.9 x 3.5 12.0 x 8.38 x 0.138   |
| 3905265C               | FM1825          | PAPER     | 2 PASS            | 54              | INT TH      | 215.0 x 168.4 x 2.9 8.46 x 6.63 x 0.116   |
| 3914044                | FM8105          | GRAPHITE  | SPR/RAD/WAG       | 85              | INT TH      | 381.0 x 307.3 x 6.4 15.0 x 12.1 x 0.252   |
| 3914047                | FM8108MP        | STEEL     | -----             | 52              | EXT TH      | 390.8 x 320.3 x 5.2 15.38 x 12.61 x 0.203 |
| 3948242C               | FM7379          | CARBON PA | WAFFLE            | 18              | INT TH      | 379.1 x 79.2 x 9.1 14.93 x 3.12 x 0.358   |
| 4179487C               | FM2263          | PAPER     | 2 PASS            | 35              | INT TH      | 184.7 x 125.7 x 4.9 7.27 x 4.95 x 0.193   |
| 4287204C               | FM1407          | PAPER     | 2 PASS            | 64              | INT TH      | 306.6 x 198.4 x 3.5 12.07 x 7.81 x 0.136  |
| 4287205C               | FM1639          | BRONZE    | SPR/RAD           | 101             | INT TH      | 311.2 x 252.5 x 5.0 12.25 x 9.94 x 0.195  |
| 4339478                | FM7563          | AFP       | 3 PASS            | 111             | INT TH      | 939.4 x 693.0 x 5.1 36.98 x 27.28 x 0.201 |
| 4339858C               | FM1631          | BRONZE    | SPR/RAD           | 96              | INT TH      | 381.0 x 300.0 x 5.6 15.0 x 11.81 x 0.22   |
| 4430663                | FM8105          | GRAPHITE  | SPR/RAD/WAG       | 85              | INT TH      | 381.0 x 307.3 x 6.4 15.0 x 12.1 x 0.252   |
| 4431922C               | FM2249          | PAPER     | 2 PASS            | 48              | INT TH      | 240.0 x 172.7 x 5.1 9.45 x 6.8 x 0.2      |
| 4476802                | FM2979          | GRAPHITE  | SPR/RAD/WAG       | 138             | INT TH      | 533.4 x 435.1 x 5.6 21.0 x 17.13 x 0.22   |
| 4569193                | FM3831          | PAPER     | 2 PASS            | 56              | EXT TH      | 239.0 x 157.0 x 4.0 9.41 x 6.18 x 0.157   |
| 4923486C               | FM2261          | PAPER     | 2 PASS            | 61              | INT TH      | 281.7 x 220.0 x 4.9 11.09 x 8.66 x 0.193  |
| 4933796                | FM7303          | CARBON PA | WAFFLE            | 62              | INT TH      | 462.0 x 192.0 x 6.2 18.19 x 7.56 x 0.244  |
| 5204220C               | FM2917          | PAPER     | 2 PASS            | 50              | INT TH      | 225.7 x 155.9 x 2.9 8.89 x 6.14 x 0.114   |
| 5352742                | FM8263          | BRONZE    | WAF/RAD           | 54              | EXT TH      | 109.4 x 82.1 x 1.6 4.31 x 3.23 x 0.063    |
| 5352747                | FM8816MP        | STEEL     | HARDENED          | 52              | INT TH      | 102.0 x 77.2 x 1.5 4.02 x 3.04 x 0.059    |
| <b>CESAB</b>           |                 |           |                   |                 |             |   |
| 993242                 | FM4815          | GRAPHITE  | SUNBURST          | 36              | (73)EX TH   | 151.5 x 101.5 x 3.5 5.96 x 4.0 x 0.138    |
| 993244                 | FM4817          | GRAPH/STL | SUN/PLAIN         | 36              | (73)EX TH   | 151.5 x 101.5 x 2.8 5.96 x 4.0 x 0.108    |
| 993247                 | FM2969          | BRONZE    | WAFFLE            | 22              | INT TH      | 71.7 x 44.0 x 1.6 2.82 x 1.73 x 0.063     |



| REPLACES<br>OEM PT.NO. | FMC<br>PART NO. | MATERIAL | GROOVE<br>DETAILS | TEETH/<br>TANGS | SIZE MM |  |  | SIZE INCH |  |  |
|------------------------|-----------------|----------|-------------------|-----------------|---------|--|--|-----------|--|--|
|------------------------|-----------------|----------|-------------------|-----------------|---------|--|--|-----------|--|--|

### CHAMPION (ALSO SEE CLARK AND ALLISON)

|       |          |        |          |    |        |       |   |       |   |     |       |   |      |   |       |
|-------|----------|--------|----------|----|--------|-------|---|-------|---|-----|-------|---|------|---|-------|
| 11299 | FM1262MP | STEEL  | -----    | 8  | EXT LG | 142.5 | x | 99.1  | x | 1.6 | 5.61  | x | 3.9  | x | 0.063 |
| 11300 | FM1361OE | BRONZE | SUNBURST | 45 | INT TH | 133.1 | x | 92.7  | x | 1.6 | 5.24  | x | 3.65 | x | 0.063 |
| 14742 | FM1305OE | BRONZE | RADIAL   | 52 | INT TH | 148.6 | x | 107.7 | x | 2.6 | 5.85  | x | 4.24 | x | 0.102 |
| 14743 | FM1216MP | STEEL  | -----    | 60 | EXT TH | 154.2 | x | 113.8 | x | 1.8 | 6.07  | x | 4.48 | x | 0.07  |
| 14748 | FM1305OE | BRONZE | RADIAL   | 52 | INT TH | 148.6 | x | 107.7 | x | 2.6 | 5.85  | x | 4.24 | x | 0.102 |
| 19435 | FM1687   | BRONZE | SUNBRST  | 34 | INT TH | 198.1 | x | 140.5 | x | 2.5 | 7.8   | x | 5.53 | x | 0.098 |
| 19436 | FM3020MP | STEEL  | -----    | 8  | EXT LG | 210.8 | x | 152.4 | x | 2.1 | 8.3   | x | 6.0  | x | 0.083 |
| 28304 | FM1324MP | STEEL  | -----    | 54 | EXT TH | 139.2 | x | 98.6  | x | 1.8 | 5.48  | x | 3.88 | x | 0.07  |
| 28305 | FM1337OE | BRONZE | RADIAL   | 45 | INT TH | 133.1 | x | 92.7  | x | 2.3 | 5.24  | x | 3.65 | x | 0.09  |
| 28310 | FM1337OE | BRONZE | RADIAL   | 45 | INT TH | 133.1 | x | 92.7  | x | 2.3 | 5.24  | x | 3.65 | x | 0.09  |
| 28311 | FM1324MP | STEEL  | -----    | 54 | EXT TH | 139.2 | x | 98.6  | x | 1.8 | 5.48  | x | 3.88 | x | 0.07  |
| 37170 | FM3011   | PAPER  | 2 PASS   | 53 | INT TH | 342.9 | x | 220.5 | x | 5.2 | 13.5  | x | 8.68 | x | 0.204 |
| 37171 | FM3014MP | STEEL  | -----    | 83 | EXT TH | 355.0 | x | 238.4 | x | 6.3 | 13.98 | x | 9.38 | x | 0.247 |
| 37934 | FM3155   | PAPER  | 3 PASS   | 54 | INT TH | 358.6 | x | 226.8 | x | 3.5 | 14.12 | x | 8.93 | x | 0.136 |
| 37935 | FM3158MP | STEEL  | -----    | 89 | EXT TH | 378.5 | x | 254.0 | x | 3.2 | 14.9  | x | 10.0 | x | 0.123 |
| 41092 | FM1649   | PAPER  | 2 PASS   | 45 | INT TH | 133.1 | x | 92.7  | x | 1.6 | 5.24  | x | 3.65 | x | 0.063 |
| 41112 | FM2379   | BRONZE | SUNBURST | 29 | INT TH | 168.1 | x | 119.1 | x | 2.5 | 6.62  | x | 4.69 | x | 0.1   |
| 41113 | FM2382MP | STEEL  | -----    | 8  | EXT LG | 180.1 | x | 129.5 | x | 2.1 | 7.09  | x | 5.1  | x | 0.083 |
| 42269 | FM2952MP | STEEL  | -----    | 4  | EXT LG | 316.5 | x | 198.5 | x | 3.1 | 12.46 | x | 7.81 | x | 0.122 |
| 48524 | FM2949   | BRONZE | SUNBURST | 54 | INT TH | 278.0 | x | 169.7 | x | 6.0 | 10.94 | x | 6.68 | x | 0.236 |
| 49987 | FM3014MP | STEEL  | -----    | 83 | EXT TH | 355.0 | x | 238.4 | x | 6.3 | 13.98 | x | 9.38 | x | 0.247 |
| 53950 | FM1361OE | BRONZE | SUNBURST | 45 | INT TH | 133.1 | x | 92.7  | x | 1.6 | 5.24  | x | 3.65 | x | 0.063 |
| 53951 | FM2379   | BRONZE | SUNBURST | 29 | INT TH | 168.1 | x | 119.1 | x | 2.5 | 6.62  | x | 4.69 | x | 0.1   |
| 55272 | FM2382MP | STEEL  | -----    | 8  | EXT LG | 180.1 | x | 129.5 | x | 2.1 | 7.09  | x | 5.1  | x | 0.083 |
| 63167 | FM2949   | BRONZE | SUNBURST | 54 | INT TH | 278.0 | x | 169.7 | x | 6.0 | 10.94 | x | 6.68 | x | 0.236 |
| 66315 | FM2952MP | STEEL  | -----    | 4  | EXT LG | 316.5 | x | 198.5 | x | 3.1 | 12.46 | x | 7.81 | x | 0.122 |
| 87537 | FM4250MP | STEEL  | -----    | 83 | EXT TH | 355.0 | x | 238.4 | x | 3.5 | 13.98 | x | 9.39 | x | 0.137 |

### CHELSEA

|        |          |           |        |    |        |       |   |      |   |     |      |   |      |   |       |
|--------|----------|-----------|--------|----|--------|-------|---|------|---|-----|------|---|------|---|-------|
| 379488 | FM1324MP | STEEL     | -----  | 54 | EXT TH | 139.2 | x | 98.6 | x | 1.8 | 5.48 | x | 3.88 | x | 0.07  |
| 379489 | FM1649R  | GREEN PA. | WAFFLE | 45 | INT TH | 133.1 | x | 92.7 | x | 1.6 | 5.24 | x | 3.65 | x | 0.063 |
| 379776 | FM1324MP | STEEL     | -----  | 54 | EXT TH | 139.2 | x | 98.6 | x | 1.8 | 5.48 | x | 3.88 | x | 0.07  |

### CHINA GEAR

|              |          |        |           |    |        |       |   |       |   |     |      |   |      |   |       |
|--------------|----------|--------|-----------|----|--------|-------|---|-------|---|-----|------|---|------|---|-------|
| MB242-01-006 | FM4362MP | STEEL  | -----     | 42 | INT TH | 156.0 | x | 102.4 | x | 2.0 | 6.14 | x | 4.03 | x | 0.079 |
| MB242-01-007 | FM4359   | BRONZE | SUNBURST  | 54 | EXT TH | 165.0 | x | 110.0 | x | 3.0 | 6.5  | x | 4.33 | x | 0.118 |
| 1201-0007    | FM2281   | BRONZE | SUNBURST  | 50 | EXT TH | 179.6 | x | 116.3 | x | 3.0 | 7.07 | x | 4.58 | x | 0.118 |
| 1201-0018    | FM2283   | BRONZE | SUN/PLAIN | 50 | EXT TH | 179.6 | x | 116.3 | x | 2.5 | 7.07 | x | 4.58 | x | 0.098 |
| 1201-0019    | FM2286MP | STEEL  | DISHED    | 36 | INT TH | 169.8 | x | 90.4  | x | 3.0 | 6.69 | x | 3.56 | x | 0.118 |
| 120C-01-008  | FM4363   | BRONZE | SUNBURST  | 46 | EXT TH | 143.0 | x | 85.0  | x | 2.6 | 5.63 | x | 3.35 | x | 0.102 |
| 120C-01-009  | FM4366MP | STEEL  | -----     | 32 | INT TH | 132.0 | x | 77.0  | x | 2.0 | 5.2  | x | 3.03 | x | 0.079 |
| 300-01-009   | FM4355   | BRONZE | SUNBURST  | 60 | EXT TH | 213.5 | x | 150.0 | x | 3.0 | 8.41 | x | 5.9  | x | 0.118 |
| 300-01-010   | FM4358MP | STEEL  | -----     | 48 | INT TH | 200.0 | x | 141.0 | x | 3.0 | 7.87 | x | 5.55 | x | 0.118 |
| ZL20-032103  | FM7004MP | STEEL  | DISHED    | 36 | INT TH | 169.8 | x | 103.2 | x | 3.0 | 6.69 | x | 4.06 | x | 0.118 |



# Clark Dana Transmission Discs

---



| REPLACES OEM PT.NO. | FMC PART NO. | MATERIAL | GROOVE DETAILS | TEETH/TANGS | SIZE MM | SIZE INCH |
|---------------------|--------------|----------|----------------|-------------|---------|-----------|
|---------------------|--------------|----------|----------------|-------------|---------|-----------|

### CLAAS

|            |          |           |          |    |           |                      |                      |
|------------|----------|-----------|----------|----|-----------|----------------------|----------------------|
| 316732     | FM2823   | PAPER     | 2 PASS   | 36 | INT TH    | 223.0 x 71.0 x 4.9   | 8.78 x 2.8 x 0.191   |
| 319648     | FM3414MP | END PLATE | -----    | 32 | (64)EX TH | 230.0 x 152.5 x 10.8 | 9.06 x 6.0 x 0.397   |
| 319649     | FM7337   | PAPER     | 2 PASS   | 36 | INT TH    | 223.0 x 71.0 x 4.9   | 8.78 x 2.8 x 0.191   |
| 319650     | FM3912MP | END PLATE | -----    | 64 | EXT TH    | 230.0 x 152.5 x 5.0  | 9.06 x 6.0 x 0.197   |
| 321528     | FM2971   | BRONZE    | WAFFLE   | 22 | INT TH    | 71.7 x 44.0 x 2.8    | 2.82 x 1.73 x 0.11   |
| 321529     | FM3474MP | STEEL     | -----    | 4  | EXT LG    | 85.0 x 49.2 x 1.5    | 3.35 x 1.94 x 0.059  |
| 321530     | FM2969   | BRONZE    | WAFFLE   | 22 | INT TH    | 71.7 x 44.0 x 1.6    | 2.82 x 1.73 x 0.063  |
| 322225     | FM2781   | GRAPHITE  | SUNBURST | 15 | INT TH    | 213.0 x 44.0 x 10.0  | 8.38 x 1.73 x 0.394  |
| 323994     | FM3824MP | STEEL     | -----    | 2  | EXT LG    | 195.0 x 110.0 x 2.6  | 7.68 x 4.33 x 0.102  |
| 323995     | FM3103   | GRAPHITE  | WAFFLE   | 28 | INT TH    | 169.0 x 56.0 x 4.8   | 6.65 x 2.21 x 0.189  |
| 11125290   | FM8474MP | STEEL     | -----    | 4  | EXT LG    | 124.9 x 89.1 x 1.5   | 4.92 x 3.51 x 0.059  |
| 11125300   | FM8476MP | STEEL     | -----    | 4  | EXT LG    | 124.1 x 89.2 x 3.0   | 4.89 x 3.51 x 0.118  |
| 11317680   | FM5926MP | STEEL     | -----    | 69 | EXT TH    | 177.0 x 132.0 x 1.9  | 6.97 x 5.2 x 0.075   |
| 11317690   | FM5923   | PAPER     | 2 PASS   | 60 | INT TH    | 169.0 x 124.6 x 2.8  | 6.65 x 4.91 x 0.11   |
| 6000104638 | FM2828MP | STEEL     | -----    | 6  | EXT LG    | 151.0 x 98.0 x 2.5   | 5.94 x 3.86 x 0.098  |
| 6000104639 | FM2825   | BRONZE    | SUNBURST | 45 | INT TH    | 133.0 x 93.0 x 1.8   | 5.24 x 3.66 x 0.069  |
| 6005023516 | FM9062MP | STEEL     | -----    | 6  | EXT LG    | 334.5 x 218.8 x 4.0  | 13.17 x 8.61 x 0.156 |
| 7700026887 | FM8465   | BRONZE    | WAFFLE   | 6  | INT LG    | 172.8 x 140.4 x 2.0  | 6.8 x 5.53 x 0.078   |
| 7700026888 | FM8471   | BRONZE    | WAFFLE   | 6  | INT LG    | 112.8 x 81.3 x 2.0   | 4.44 x 3.2 x 0.078   |
| 7700037434 | FM7265   | PAPER     | WAFFLE   | 38 | INT TH    | 167.0 x 111.7 x 3.3  | 6.57 x 4.4 x 0.13    |
| 7700060850 | FM8468MP | STEEL     | -----    | 6  | EXT LG    | 190.6 x 147.6 x 1.5  | 7.5 x 5.81 x 0.059   |

### CLARK / DANA

|        |          |                      |          |     |           |                      |                       |
|--------|----------|----------------------|----------|-----|-----------|----------------------|-----------------------|
| 122069 | FM7980MP | STEEL                | SUNBURST | 32  | (36)IN TH | 156.8 x 89.0 x 6.4   | 6.17 x 3.5 x 0.25     |
| 208772 | FM0647   | BRONZE               | SUNBURST | 19  | INT TH    | 165.1 x 74.2 x 4.0   | 6.5 x 2.92 x 0.156    |
| 208773 | FM1816MP | STEEL                | DISHED   | 32  | (42)EX TH | 184.2 x 92.7 x 2.6   | 7.25 x 3.65 x 0.102   |
| 209669 | FM5942MP | STEEL                | DISHED   | 35  | (47)EX TH | 204.5 x 113.2 x 2.7  | 8.05 x 4.46 x 0.106   |
| 209928 | FM0647   | BRONZE               | SUNBURST | 19  | INT TH    | 165.1 x 74.2 x 4.0   | 6.5 x 2.92 x 0.156    |
| 209929 | FM0123   | OBSOLETE AFTER STOCK |          | 24  | INT TH    | 187.5 x 95.3 x 4.0   | 7.38 x 3.75 x 0.157   |
| 215178 | FM1305OE | BRONZE               | RADIAL   | 52  | INT TH    | 148.6 x 107.7 x 2.6  | 5.85 x 4.24 x 0.102   |
| 215222 | FM1309   | BRONZE               | RADIAL   | 52  | INT TH    | 148.6 x 107.7 x 2.6  | 5.85 x 4.24 x 0.102   |
| 215255 | FM1309   | BRONZE               | RADIAL   | 52  | INT TH    | 148.6 x 107.7 x 2.6  | 5.85 x 4.24 x 0.102   |
| 216050 | FM3467   | BRONZE               | SUNBURST | 34  | INT TH    | 205.0 x 114.8 x 3.9  | 8.07 x 4.52 x 0.154   |
| 216084 | FM1309   | BRONZE               | RADIAL   | 52  | INT TH    | 148.6 x 107.7 x 2.6  | 5.85 x 4.24 x 0.102   |
| 216677 | FM0647   | BRONZE               | SUNBURST | 19  | INT TH    | 165.1 x 74.2 x 4.0   | 6.5 x 2.92 x 0.156    |
| 217140 | FM1218MP | STEEL                | -----    | 16  | (24)EX TH | 257.3 x 190.5 x 2.7  | 10.13 x 7.5 x 0.106   |
| 217162 | FM1278MP | STEEL                | -----    | 14  | (20)EX TH | 218.9 x 158.8 x 2.7  | 8.62 x 6.25 x 0.106   |
| 217163 | FM1191   | GRAPHITE             | SUNBURST | 60  | INT TH    | 195.1 x 145.0 x 4.0  | 7.68 x 5.71 x 0.156   |
| 217163 | FM1195   | BRONZE               | SUNBURST | 60  | INT TH    | 195.1 x 145.0 x 4.0  | 7.68 x 5.71 x 0.156   |
| 217757 | FM1195   | BRONZE               | SUNBURST | 60  | INT TH    | 195.1 x 145.0 x 4.0  | 7.68 x 5.71 x 0.156   |
| 218714 | FM6478MP | STEEL                | -----    | 106 | EXT TH    | 341.0 x 267.5 x 4.8  | 13.43 x 10.53 x 0.189 |
| 218715 | FM2727   | GRAPHITE             | SUNBURST | 80  | INT TH    | 326.9 x 247.9 x 5.5  | 12.87 x 9.76 x 0.216  |
| 218716 | FM6480MP | STEEL                | -----    | 106 | EXT TH    | 341.0 x 267.5 x 12.5 | 13.43 x 10.53 x 0.492 |
| 219393 | FM6352MP | STEEL                | DISHED   | 42  | (49)EX TH | 160.9 x 103.3 x 1.5  | 6.33 x 4.07 x 0.059   |
| 222171 | FM3467   | BRONZE               | SUNBURST | 34  | INT TH    | 205.0 x 114.8 x 3.9  | 8.07 x 4.52 x 0.154   |
| 222173 | FM3428MP | STEEL                | -----    | 17  | (34)EX TH | 225.0 x 133.6 x 2.7  | 8.86 x 5.26 x 0.106   |
| 222391 | FM5807   | BRONZE               | SPIRAL   | 25  | INT TH    | 147.5 x 74.3 x 4.0   | 5.81 x 2.93 x 0.157   |

| REPLACES<br>OEM PT.NO. | FMC<br>PART NO. | MATERIAL  | GROOVE<br>DETAILS | TEETH/<br>TANGS | SIZE MM   | SIZE INCH                                  |
|------------------------|-----------------|-----------|-------------------|-----------------|-----------|--|
| 222605                 | FM6352MP        | STEEL     | DISHED            | 42              | (49)EX TH | 160.9 x 103.3 x 1.5 6.33 x 4.07 x 0.059    |
| 224246                 | FM1230MP        | STEEL     | -----             | 4               | EXT LG    | 155.7 x 115.8 x 1.7 6.13 x 4.56 x 0.066    |
| 224338                 | FM3382FP        | STEEL     | FLEXI PLATE       | 6               | HOLE      | 339.7 x 133.4 x 1.5 13.37 x 5.25 x 0.059   |
| 224339                 | FM4442FP        | STEEL     | REINF PLATE       | 6               | HOLE      | 186.5 x 132.0 x 2.1 7.34 x 5.2 x 0.83      |
| 224772                 | FM1216MP        | STEEL     | -----             | 60              | EXT TH    | 154.2 x 113.8 x 1.8 6.07 x 4.48 x 0.07     |
| 224774                 | FM7462MP        | END PLATE | -----             | 60              | EXT TH    | 154.3 x 113.5 x 8.0 6.07 x 4.47 x 0.315    |
| 226595                 | FM3299OF        | ASB FREE  | 24 HOLES          | 90              | INT TH    | 451.1 x 374.9 x 28.0 17.76 x 14.76 x 1.102 |
| 226595GSM              | FM3299G         | NYLON     | 24 HOLES          | 90              | INT TH    | 451.1 x 374.9 x 28.0 17.76 x 14.76 x 1.102 |
| 227495                 | FM1195          | BRONZE    | SUNBURST          | 60              | INT TH    | 195.1 x 145.0 x 4.0 7.68 x 5.71 x 0.156    |
| 227496                 | FM1197          | BRONZE    | SUNBURST          | 72              | INT TH    | 233.4 x 175.5 x 4.0 9.19 x 6.91 x 0.156    |
| 227496                 | FM1193          | GRAPHITE  | SUNBURST          | 72              | INT TH    | 233.4 x 175.5 x 4.0 9.19 x 6.91 x 0.156    |
| 227497                 | FM1197          | BRONZE    | SUNBURST          | 72              | INT TH    | 233.4 x 175.5 x 4.0 9.19 x 6.91 x 0.156    |
| 228114                 | FM1305OE        | BRONZE    | RADIAL            | 52              | INT TH    | 148.6 x 107.7 x 2.6 5.85 x 4.24 x 0.102    |
| 230594                 | 230594          | BACKPLATE | 24 HOLES          |                 |           | 457.0 x 393.0 x 4.0 17.99 x 15.47 x 0.157  |
| 230911                 | FM1307OE        | BRONZE    | RADIAL            | 52              | INT TH    | 148.6 x 107.7 x 2.6 5.85 x 4.24 x 0.102    |
| 232155                 | FM1197          | BRONZE    | SUNBURST          | 72              | INT TH    | 233.4 x 175.5 x 4.0 9.19 x 6.91 x 0.156    |
| 232159                 | FM1657B         | BRONZE    | SPR/RAD           | 45              | INT TH    | 133.4 x 92.7 x 2.1 5.25 x 3.65 x 0.082     |
| 232285                 | FM1218MP        | STEEL     | -----             | 16              | (24)EX TH | 257.3 x 190.5 x 2.7 10.13 x 7.5 x 0.106    |
| 232316                 | FM1195          | BRONZE    | SUNBURST          | 60              | INT TH    | 195.1 x 145.0 x 4.0 7.68 x 5.71 x 0.156    |
| 232394                 | FM1278MP        | STEEL     | -----             | 14              | (20)EX TH | 218.9 x 158.8 x 2.7 8.62 x 6.25 x 0.106    |
| 232395                 | FM2758MP        | STEEL     | -----             | 21              | (28)EX TH | 314.2 x 227.3 x 2.6 12.37 x 8.95 x 0.102   |
| 232584                 | FM1381OE        | BRONZE    | RADIAL            | 52              | INT TH    | 148.6 x 107.7 x 2.9 5.85 x 4.24 x 0.114    |
| 232628                 | FM2383          | GRAPHITE  | 2 PASS            | 72              | INT TH    | 233.4 x 175.5 x 4.0 9.19 x 6.91 x 0.156    |
| 232635                 | FM1218MP        | STEEL     | -----             | 16              | (24)EX TH | 257.3 x 190.5 x 2.7 10.13 x 7.5 x 0.106    |
| 232778                 | FM1191          | GRAPHITE  | SUNBURST          | 60              | INT TH    | 195.1 x 145.0 x 4.0 7.68 x 5.71 x 0.156    |
| 232779                 | FM1193          | GRAPHITE  | SUNBURST          | 72              | INT TH    | 233.4 x 175.5 x 4.0 9.19 x 6.91 x 0.156    |
| 232780                 | FM2725          | GRAPHITE  | SUNBURST          | 60              | INT TH    | 292.1 x 207.0 x 4.0 11.5 x 8.15 x 0.156    |
| 232781                 | OBSOLETE        | GRAPHITE  | SUNBURST          | 68              | INT TH    | 327.0 x 236.1 x 4.8 12.88 x 9.3 x 0.188    |
| 233089                 | FM1497OF        | ORGANIC   | 16 HOLES          | 96              | INT TH    | 357.9 x 298.5 x 20.8 14.09 x 11.75 x 0.819 |
| 233089GSM              | FM1497G         | NYLON     | 16HOLES           | 96              | INT TH    | 357.9 x 298.5 x 20.8 14.09 x 11.75 x 0.819 |
| 233166                 | FM1305OE        | BRONZE    | RADIAL            | 52              | INT TH    | 148.6 x 107.7 x 2.6 5.85 x 4.24 x 0.102    |
| 234108                 | FM2027          | BRONZE    | WAFFLE            | 45              | INT TH    | 133.1 x 92.7 x 2.4 5.24 x 3.65 x 0.094     |
| 234109                 | FM1324MP        | STEEL     | -----             | 54              | EXT TH    | 139.2 x 98.6 x 1.8 5.48 x 3.88 x 0.07      |
| 234324                 | FM3648MP        | END PLATE | STEPPED           | 54              | EXT TH    | 139.2 x 98.6 x 9.0 5.48 x 3.88 x 0.354     |
| 234336                 | FM1375OE        | BRONZE    | RADIAL            | 45              | INT TH    | 133.1 x 92.7 x 2.4 5.24 x 3.65 x 0.093     |
| 234727                 | FM1309          | BRONZE    | RADIAL            | 52              | INT TH    | 148.6 x 107.7 x 2.6 5.85 x 4.24 x 0.102    |
| 235161                 | FM1309          | BRONZE    | RADIAL            | 52              | INT TH    | 148.6 x 107.7 x 2.6 5.85 x 4.24 x 0.102    |
| 236199                 | OBSOLETE        | ASB FREE  | 32HOLES 3/8"      | 96              | INT TH    | 357.9 x 298.5 x 20.8 14.09 x 11.75 x 0.819 |
| 236199GSM              | OBSOLETE        | NYLON     | 32HOLES 3/8"      | 96              | INT TH    | 357.9 x 298.5 x 17.5 14.09 x 11.75 x 0.689 |
| 236847                 | FM3648MP        | END PLATE | STEPPED           | 54              | EXT TH    | 139.2 x 98.6 x 9.0 5.48 x 3.88 x 0.354     |
| 236936                 | FM1563OF        | ASB FREE  | 32HOLES           | 96              | INT TH    | 357.9 x 298.5 x 20.8 14.09 x 11.75 x 0.819 |
| 236936GSM              | FM1563G         | NYLON     | 32HOLES 5/16"     | 96              | INT TH    | 357.9 x 298.5 x 20.8 14.09 x 11.75 x 0.819 |
| 236937                 | FM3242BP        | BACKPLATE | 32HOLES           |                 |           | 354.0 x 314.0 x 4.0 13.94 x 12.36 x 0.157  |
| 236989                 | FM1381OE        | BRONZE    | RADIAL            | 52              | INT TH    | 148.6 x 107.7 x 2.9 5.85 x 4.24 x 0.114    |
| 237016                 | FM1337OE        | BRONZE    | RADIAL            | 45              | INT TH    | 133.1 x 92.7 x 2.3 5.24 x 3.65 x 0.09      |
| 238174                 | FM1278MP        | STEEL     | -----             | 14              | (20)EX TH | 218.9 x 158.8 x 2.7 8.62 x 6.25 x 0.106    |
| 238310                 | FM6200MP        | STEEL     | -----             | 7               | (28)EX TH | 314.2 x 227.3 x 2.6 12.37 x 8.95 x 0.102   |

| REPLACES<br>OEM PT.NO. | FMC<br>PART NO. | MATERIAL  | GROOVE<br>DETAILS | TEETH/<br>TANGS | SIZE MM   |       |   | SIZE INCH |   |      |       |   |       |   |       |
|------------------------|-----------------|-----------|-------------------|-----------------|-----------|-------|---|-----------|---|------|-------|---|-------|---|-------|
| 238313                 | FM1305OE        | BRONZE    | RADIAL            | 52              | INT TH    | 148.6 | x | 107.7     | x | 2.6  | 5.85  | x | 4.24  | x | 0.102 |
| 238609                 | FM2029          | PAPER     | 2 PASS            | 52              | INT TH    | 148.6 | x | 107.7     | x | 2.9  | 5.85  | x | 4.24  | x | 0.114 |
| 242101                 | FM1337OE        | BRONZE    | RADIAL            | 45              | INT TH    | 133.1 | x | 92.7      | x | 2.3  | 5.24  | x | 3.65  | x | 0.09  |
| 242530                 | FM1337OE        | BRONZE    | RADIAL            | 45              | INT TH    | 133.1 | x | 92.7      | x | 2.3  | 5.24  | x | 3.65  | x | 0.09  |
| 242716                 | FM2737          | GRAPHITE  | SUNBURST          | 60              | INT TH    | 212.6 | x | 145.0     | x | 4.0  | 8.37  | x | 5.71  | x | 0.156 |
| 242717                 | FM1960MP        | STEEL     | -----             | 35              | EXT TH    | 228.1 | x | 159.0     | x | 2.7  | 8.98  | x | 6.26  | x | 0.105 |
| 243099                 | FM1197          | BRONZE    | SUNBURST          | 72              | INT TH    | 233.4 | x | 175.5     | x | 4.0  | 9.19  | x | 6.91  | x | 0.156 |
| 243329                 | FM2733          | GRAPHITE  | SUNBURST          | 72              | INT TH    | 244.2 | x | 175.5     | x | 4.0  | 9.62  | x | 6.91  | x | 0.156 |
| 243330                 | FM3560MP        | STEEL     | -----             | 40              | EXT TH    | 260.0 | x | 191.0     | x | 2.6  | 10.24 | x | 7.52  | x | 0.1   |
| 243497                 | FM8909          | BRONZE    | SUNBURST          | 87              | INT TH    | 306.0 | x | 258.6     | x | 4.0  | 12.05 | x | 10.18 | x | 0.156 |
| 243691                 | FM2738MP        | STEEL     | -----             | 71              | EXT TH    | 182.6 | x | 117.9     | x | 1.8  | 7.19  | x | 4.64  | x | 0.069 |
| 243737                 | FM3421          | BRONZE    | RADIAL            | 52              | INT TH    | 175.0 | x | 107.0     | x | 2.9  | 6.89  | x | 4.21  | x | 0.114 |
| 243765                 | FM2657OF        | OBSOLETE  | 16 HOLES          | 96              | INT TH    | 357.8 | x | 298.4     | x | 17.5 | 14.09 | x | 11.75 | x | 0.689 |
| 243765GSM              | FM2657G         | NYLON     | 16 HOLES          | 96              | INT TH    | 357.8 | x | 298.4     | x | 17.5 | 14.09 | x | 11.75 | x | 0.689 |
| 243767                 | 243767-16       | BACKPLATE | 16 HOLES          |                 |           | 354.0 | x | 314.0     | x | 4.0  | 13.94 | x | 12.36 | x | 0.157 |
| 244133                 | FM2718MP        | STEEL     | -----             | 4               | EXT LG    | 129.0 | x | 76.0      | x | 1.5  | 5.08  | x | 2.99  | x | 0.059 |
| 244134                 | FM2719          | PAPER     | 2 PASS            | 33              | INT TH    | 117.9 | x | 68.1      | x | 2.2  | 4.64  | x | 2.68  | x | 0.087 |
| 244979                 | FM2787          | GRAPHITE  | SUNBURST          | 52              | INT TH    | 175.3 | x | 106.7     | x | 2.9  | 6.9   | x | 4.2   | x | 0.114 |
| 244980                 | FM2738MP        | STEEL     | -----             | 71              | EXT TH    | 182.6 | x | 117.9     | x | 1.8  | 7.19  | x | 4.64  | x | 0.069 |
| 245238                 | FM2718MP        | STEEL     | -----             | 4               | EXT LG    | 129.0 | x | 76.0      | x | 1.5  | 5.08  | x | 2.99  | x | 0.059 |
| 245239                 | FM2719          | PAPER     | 2 PASS            | 33              | INT TH    | 117.9 | x | 68.1      | x | 2.2  | 4.65  | x | 2.68  | x | 0.087 |
| 245268                 | FM4036MP        | END PLATE | STEPPED           | 4               | EXT LG    | 129.0 | x | 74.0      | x | 5.0  | 5.08  | x | 2.91  | x | 0.197 |
| 245741                 | FM4253          | PAPER     | 2 PASS            | 45              | INT TH    | 133.3 | x | 92.6      | x | 2.4  | 5.25  | x | 3.65  | x | 0.095 |
| 245917                 | FM4486MP        | STEEL     | HARDENED          | 60              | EXT TH    | 154.2 | x | 113.8     | x | 1.8  | 6.07  | x | 4.48  | x | 0.07  |
| 245935                 | FM2383          | GRAPHITE  | 2 PASS            | 72              | INT TH    | 233.4 | x | 175.5     | x | 4.0  | 9.19  | x | 6.91  | x | 0.156 |
| 246744                 | FM2719          | PAPER     | 2 PASS            | 33              | INT TH    | 117.9 | x | 68.1      | x | 2.2  | 4.65  | x | 2.68  | x | 0.087 |
| 247041                 | FM3299OF        | ASB FREE  | 24 HOLES          | 90              | INT TH    | 451.1 | x | 374.9     | x | 28.0 | 17.76 | x | 14.76 | x | 1.102 |
| 247041GSM              | FM3299G         | NYLON     | 24 HOLES          | 90              | INT TH    | 451.1 | x | 374.9     | x | 28.0 | 17.76 | x | 14.76 | x | 1.102 |
| 247273                 | FM2738MP        | STEEL     | -----             | 71              | EXT TH    | 182.6 | x | 117.9     | x | 1.8  | 7.19  | x | 4.64  | x | 0.069 |
| 247274                 | FM1216MP        | STEEL     | -----             | 60              | EXT TH    | 154.2 | x | 113.8     | x | 1.8  | 6.07  | x | 4.48  | x | 0.07  |
| 247274                 | FM4486MP        | STEEL     | HARDENED          | 60              | EXT TH    | 154.2 | x | 113.8     | x | 1.8  | 6.07  | x | 4.48  | x | 0.07  |
| 250421                 | FM6198MP        | STEEL     | -----             | 7               | (28)EX TH | 314.2 | x | 227.3     | x | 2.0  | 12.37 | x | 8.95  | x | 0.079 |
| 251393                 | FM6202MP        | STEEL     | -----             | 40              | EXT TH    | 260.0 | x | 191.0     | x | 2.0  | 10.24 | x | 7.52  | x | 0.079 |
| 251691                 | FM5233          | CARBON PA | 2 PASS            | 72              | INT TH    | 233.4 | x | 175.5     | x | 4.0  | 9.19  | x | 6.91  | x | 0.156 |
| 251692                 | FM5227          | CARBON PA | 2 PASS            | 60              | INT TH    | 195.1 | x | 145.0     | x | 4.0  | 7.68  | x | 5.71  | x | 0.156 |
| 251702                 | FM2733          | GRAPHITE  | SUNBURST          | 72              | INT TH    | 244.2 | x | 175.5     | x | 4.0  | 9.62  | x | 6.91  | x | 0.156 |
| 251703                 | FM5237          | CARBON PA | 2 PASS            | 60              | INT TH    | 292.0 | x | 207.0     | x | 4.0  | 11.5  | x | 8.15  | x | 0.156 |
| 251704                 | FM5229          | CARBON PA | 2 PASS            | 52              | INT TH    | 175.3 | x | 106.7     | x | 3.0  | 6.9   | x | 4.2   | x | 0.116 |
| 251708                 | FM5239          | CARBON PA | 2 PASS            | 80              | INT TH    | 326.9 | x | 247.9     | x | 5.5  | 12.87 | x | 9.76  | x | 0.216 |
| 801780                 | FM1497KIT       | ORGANIC   | 16 HOLES          | 96              | INT TH    | 357.9 | x | 298.5     | x | 20.8 | 14.09 | x | 11.75 | x | 0.819 |
| 801780GSM              | FM1497GK        | NYLON     | 16 HOLES          | 96              | INT TH    | 357.9 | x | 298.5     | x | 20.8 | 14.09 | x | 11.75 | x | 0.819 |
| 801874                 | FM3299KIT       | ASB FREE  | 24 HOLES          | 90              | INT TH    | 451.1 | x | 374.9     | x | 28.0 | 17.76 | x | 14.76 | x | 1.102 |
| 801874BP/GSM           | FM3299BGK       | NYLON     | 24 HOLES          | 90              | INT TH    | 451.1 | x | 374.9     | x | 28.0 | 17.76 | x | 14.76 | x | 1.102 |
| 801874GSM              | FM3299GK        | NYLON     | 24 HOLES          | 90              | INT TH    | 451.1 | x | 374.9     | x | 28.0 | 17.76 | x | 14.76 | x | 1.102 |
| 802051                 | KIT             | 8XFM2029  | 8XFM1216MP        |                 |           |       |   |           |   |      |       |   |       |   |       |
| 802183                 | FM2657KIT       | OBSOLETE  | 16 HOLES          | 96              | INT TH    | 357.8 | x | 298.4     | x | 17.5 | 14.09 | x | 11.75 | x | 0.689 |
| 802183GSM              | FM2657GK        | NYLON     | 16 HOLES          | 96              | INT TH    | 357.8 | x | 298.4     | x | 17.5 | 14.09 | x | 11.75 | x | 0.689 |
| 802392                 | FM2657BK        | OBSOLETE  | 16HOLES           | 96              | INT TH    | 357.9 | x | 298.5     | x | 17.5 | 14.09 | x | 11.75 | x | 0.689 |

| REPLACES<br>OEM PT.NO. | FMC<br>PART NO. | MATERIAL   | GROOVE<br>DETAILS | TEETH/<br>TANGS | SIZE MM   |       |   | SIZE INCH |   |      |       |   |       |   |       |
|------------------------|-----------------|------------|-------------------|-----------------|-----------|-------|---|-----------|---|------|-------|---|-------|---|-------|
| 802392GSM              | FM2657GK        | NYLON      | 16 HOLES          | 96              | INT TH    | 357.8 | x | 298.4     | x | 17.5 | 14.09 | x | 11.75 | x | 0.689 |
| 802495BP/GSM           | FM3299BGK       | NYLON      | 24 HOLES          | 90              | INT TH    | 451.1 | x | 374.9     | x | 28.0 | 17.76 | x | 14.76 | x | 1.102 |
| 802495GSM              | FM3299GK        | NYLON      | 24 HOLES          | 90              | INT TH    | 451.1 | x | 374.9     | x | 28.0 | 17.76 | x | 14.76 | x | 1.102 |
| 802539                 | FM3299GK        | NYLON      | 24 HOLES          | 90              | INT TH    | 451.1 | x | 374.9     | x | 28.0 | 17.76 | x | 14.76 | x | 1.102 |
| 802544GSM              | FM3227GK        | OBSOLETE   | 32HOLES           | 96              | INT TH    | 357.9 | x | 298.5     | x | 17.5 | 14.09 | x | 11.75 | x | 0.689 |
| 802553P                | FM1497GK        | NYLON      | 16 HOLES          | 96              | INT TH    | 357.9 | x | 298.5     | x | 20.8 | 14.09 | x | 11.75 | x | 0.819 |
| 802643                 | FM2657BGK       | NYLON      | 16 HOLES          | 96              | INT TH    | 357.9 | x | 298.5     | x | 17.5 | 14.09 | x | 11.75 | x | 0.689 |
| 802647                 | FM2657KIT       | OBSOLETE   | 16 HOLES          | 96              | INT TH    | 357.8 | x | 298.4     | x | 17.5 | 14.09 | x | 11.75 | x | 0.689 |
| 878366                 | FM5452MP        | STEEL      | END PLATE         | 54              | EXT TH    | 139.2 | x | 98.2      | x | 8.7  | 5.48  | x | 3.87  | x | 0.343 |
| 878372                 | FM5442MP        | STEEL      | END PLATE         | 54              | EXT TH    | 139.2 | x | 98.2      | x | 8.3  | 5.48  | x | 3.87  | x | 0.327 |
| 878373                 | FM1935          | BRONZE     | 240 RADIAL        | 45              | INT TH    | 133.1 | x | 92.7      | x | 1.6  | 5.24  | x | 3.65  | x | 0.063 |
| 878374                 | FM1324MP        | STEEL      | -----             | 54              | EXT TH    | 139.2 | x | 98.6      | x | 1.8  | 5.48  | x | 3.88  | x | 0.07  |
| 884369                 | FM4442FP        | STEEL      | REINF PLATE       | 6               | HOLE      | 186.5 | x | 132.0     | x | 2.1  | 7.34  | x | 5.2   | x | 0.83  |
| 887983                 | FM1933          | BRONZE     | RADIAL            | 59              | INT TH    | 190.8 | x | 147.3     | x | 3.0  | 7.51  | x | 5.8   | x | 0.118 |
| 887984                 | FM1938MP        | STEEL      | -----             | 3               | EXT LG    | 214.9 | x | 155.7     | x | 1.8  | 8.46  | x | 6.13  | x | 0.07  |
| 888027                 | FM1935          | BRONZE     | 240 RADIAL        | 45              | INT TH    | 133.1 | x | 92.7      | x | 1.6  | 5.24  | x | 3.65  | x | 0.063 |
| 907566                 | FM2829          | PAPER      | 2 PASS            | 45              | INT TH    | 133.1 | x | 92.7      | x | 2.1  | 5.24  | x | 3.65  | x | 0.083 |
| 907567                 | FM3650MP        | STEEL      | -----             | 54              | EXT TH    | 139.2 | x | 98.6      | x | 3.0  | 5.48  | x | 3.88  | x | 0.118 |
| 927618                 | FM5904MP        | STEEL      | -----             | 6               | EXT LG    | 152.5 | x | 95.0      | x | 4.0  | 6.0   | x | 3.74  | x | 0.157 |
| 927619                 | FM3373          | PAPER      | 2 PASS            | 36              | INT TH    | 134.0 | x | 87.8      | x | 2.3  | 5.28  | x | 3.46  | x | 0.093 |
| 927620                 | FM3376MP        | STEEL      | -----             | 6               | EX LG     | 152.5 | x | 95.0      | x | 2.0  | 6.0   | x | 3.74  | x | 0.079 |
| 927707                 | FM3377          | PAPER      | 2 PASS            | 62              | INT TH    | 204.0 | x | 152.7     | x | 3.7  | 8.03  | x | 6.01  | x | 0.148 |
| 927708                 | FM3380MP        | STEEL      | -----             | 70              | (74)EX TH | 209.0 | x | 161.0     | x | 2.5  | 8.23  | x | 6.34  | x | 0.1   |
| 1239226                | FM7226MP        | STEEL      | -----             | 3               | EXT SL    | 247.0 | x | 162.0     | x | 3.4  | 9.72  | x | 6.38  | x | 0.134 |
| 1239227                | FM7223          | PAPER      | WAFFLE            | 24              | INT TH    | 228.5 | x | 60.0      | x | 3.2  | 9.0   | x | 2.36  | x | 0.126 |
| 2106605                | FM1726MP        | STEEL      | -----             | 12              | EXT LG    | 414.3 | x | 254.0     | x | 4.7  | 16.31 | x | 10.0  | x | 0.185 |
| 2106606                | FM1723          | GRAPHITE   | SUNBURST          | 36              | INT TH    | 394.5 | x | 222.3     | x | 6.2  | 15.53 | x | 8.75  | x | 0.245 |
| 2108352                | FM1723          | GRAPHITE   | SUNBURST          | 36              | INT TH    | 394.5 | x | 222.3     | x | 6.2  | 15.53 | x | 8.75  | x | 0.245 |
| 2108427                | FM1782MP        | STEEL      | -----             | 9               | EXT LG    | 477.8 | x | 338.6     | x | 4.7  | 18.81 | x | 13.33 | x | 0.185 |
| 2108428                | FM1779          | GRAPHITE   | SUNBURST          | 34              | (38)IN TH | 456.7 | x | 313.7     | x | 7.8  | 17.98 | x | 12.35 | x | 0.308 |
| 2108994                | FM3292MP        | STEEL      | -----             | 30              | (55)EX TH | 474.0 | x | 338.6     | x | 4.7  | 18.66 | x | 13.33 | x | 0.185 |
| 2110446                | FM7982MP        | STEEL      | -----             | 16              | EXT TH    | 176.2 | x | 103.5     | x | 3.9  | 6.94  | x | 4.07  | x | 0.155 |
| 2110747                | FM8251          | CARBON PA  | SUNBURST          | 15              | INT TH    | 185.4 | x | 64.9      | x | 4.9  | 7.3   | x | 2.56  | x | 0.191 |
| 2110750                | FM6894MP        | STEEL      | -----             | 27              | EXT TH    | 213.1 | x | 95.2      | x | 2.6  | 8.39  | x | 3.75  | x | 0.102 |
| 2110852                | FM3679          | GRAPHITE   | SUNBURST          | 36              | INT TH    | 394.5 | x | 222.3     | x | 5.2  | 15.53 | x | 8.75  | x | 0.203 |
| 2110857                | FM5092SP        | SPRING     | -----             |                 |           |       |   |           |   |      |       |   |       |   |       |
| 2110864                | FM1726MP        | STEEL      | -----             | 12              | EXT LG    | 414.3 | x | 254.0     | x | 4.7  | 16.31 | x | 10.0  | x | 0.185 |
| 2111835                | FM2683          | GRAPHITE   | SUNBURST          | 34              | (38)IN TH | 457.2 | x | 313.4     | x | 6.8  | 18.0  | x | 12.34 | x | 0.268 |
| 2111847                | FM2686MP        | STEEL      | -----             | 48              | (96)EX TH | 499.1 | x | 337.8     | x | 4.8  | 19.65 | x | 13.3  | x | 0.187 |
| 2114524                | FM7341          | MOLYBDENUM | SPIRAL            | 22              | (37)IN TH | 128.4 | x | 76.5      | x | 4.7  | 5.06  | x | 3.01  | x | 0.185 |
| 2114639                | FM7344MP        | STEEL      | SUNB/HARD         | 12              | EXT LG    | 144.0 | x | 84.4      | x | 4.8  | 5.67  | x | 3.32  | x | 0.189 |
| 2114873                | FM7258MP        | STEEL      | -----             | 8               | EXT LG    | 327.5 | x | 198.3     | x | 4.8  | 12.89 | x | 7.81  | x | 0.189 |
| 2114880                | FM7255          | CARBON PA  | WAFFLE            | 36              | INT TH    | 305.0 | x | 56.5      | x | 5.4  | 12.01 | x | 2.22  | x | 0.211 |
| 2115238                | FM5159          | CARBON PA  | 3 PASS            | 34              | (38)IN TH | 456.7 | x | 313.7     | x | 6.8  | 17.98 | x | 12.35 | x | 0.268 |
| 2115239                | FM1782MP        | STEEL      | -----             | 9               | EXT LG    | 477.8 | x | 338.6     | x | 4.7  | 18.81 | x | 13.33 | x | 0.185 |
| 2115240                | FM3292MP        | STEEL      | -----             | 30              | (55)EX TH | 474.0 | x | 338.6     | x | 4.7  | 18.66 | x | 13.33 | x | 0.185 |
| 2115856                | FM6339          | CARBON PA  | 3 PASS            | 36              | INT TH    | 394.5 | x | 222.3     | x | 5.2  | 15.53 | x | 8.75  | x | 0.205 |

| REPLACES<br>OEM PT.NO. | FMC<br>PART NO. | MATERIAL  | GROOVE<br>DETAILS | TEETH/<br>TANGS | SIZE MM   | SIZE INCH           |                       |
|------------------------|-----------------|-----------|-------------------|-----------------|-----------|---------------------|-----------------------|
| 2115857                | FM1726MP        | STEEL     | -----             | 12              | EXT LG    | 414.3 x 254.0 x 4.7 | 16.31 x 10.0 x 0.185  |
| 2115913                | FM2686MP        | STEEL     | -----             | 48              | (96)EX TH | 499.1 x 337.8 x 4.8 | 19.65 x 13.3 x 0.187  |
| 2116295                | FM6864MP        | STEEL     | -----             | 24              | EXT LG    | 501.0 x 338.0 x 4.8 | 19.72 x 13.31 x 0.189 |
| 2787359                | FM3264MP        | STEEL     | -----             | 26              | EXT TH    | 143.5 x 89.5 x 2.2  | 5.65 x 3.52 x 0.084   |
| 2787362                | FM3902MP        | END PLATE | -----             | 26              | EXT TH    | 143.4 x 89.5 x 10.9 | 5.65 x 3.52 x 0.429   |
| 2787368                | FM3264MP        | STEEL     | -----             | 26              | EXT TH    | 143.5 x 89.5 x 2.2  | 5.65 x 3.52 x 0.084   |
| 2794675                | FM3681          | PAPER     | 2 PASS            | 40              | INT TH    | 127.1 x 82.2 x 2.7  | 5.0 x 3.24 x 0.108    |
| 2810118                | FM5475          | PAPER     | WAFFLE            | 52              | INT TH    | 148.6 x 107.7 x 3.0 | 5.85 x 4.24 x 0.118   |
| 2821953                | FM3681          | PAPER     | 2 PASS            | 40              | INT TH    | 127.1 x 82.2 x 2.7  | 5.0 x 3.24 x 0.108    |
| 2822116                | FM2719          | PAPER     | 2 PASS            | 33              | INT TH    | 117.9 x 68.1 x 2.2  | 4.64 x 2.68 x 0.087   |
| 3734356                | FM1309          | BRONZE    | RADIAL            | 52              | INT TH    | 148.6 x 107.7 x 2.6 | 5.85 x 4.24 x 0.102   |
| 4204265                | FM4995          | PAPER     | 2 PASS/PLAIN      | 54              | EXT TH    | 139.0 x 99.0 x 2.0  | 5.47 x 3.9 x 0.077    |
| 4204266                | FM4993          | PAPER     | 2 PASS            | 54              | EXT TH    | 139.0 x 99.0 x 2.7  | 5.47 x 3.9 x 0.104    |
| 4204267                | FM4998MP        | STEEL     | -----             | 45              | INT TH    | 133.0 x 92.7 x 2.0  | 5.24 x 3.65 x 0.079   |
| 4206373                | FM6049          | PAPER     | WAFFLE            | 52              | EXT TH    | 167.5 x 114.0 x 2.6 | 6.59 x 4.49 x 0.102   |
| 4206374                | FM6054MP        | STEEL     | -----             | 52              | INT TH    | 161.0 x 107.0 x 2.0 | 6.34 x 4.21 x 0.079   |
| 4206417                | FM6051          | PAPER     | WAFFLE/PLAIN      | 52              | EXT TH    | 167.5 x 114.0 x 2.0 | 6.59 x 4.49 x 0.077   |
| 4207140                | FM6048MP        | STEEL     | -----             | 52              | EXT TH    | 167.5 x 114.0 x 2.5 | 6.59 x 4.49 x 0.098   |
| 4207141                | FM6045          | PAPER     | WAFFLE            | 52              | INT TH    | 161.0 x 107.0 x 2.9 | 6.34 x 4.21 x 0.112   |
| 4207419                | FM6018MP        | STEEL     | -----             | 78              | EXT TH    | 200.0 x 114.0 x 3.0 | 7.87 x 4.49 x 0.118   |
| 4207444                | FM5376MP        | STEEL     | -----             | 45              | INT TH    | 148.3 x 92.7 x 2.3  | 5.84 x 3.65 x 0.089   |
| 4207445                | FM6437          | CARBON PA | WAFFLE            | 60              | EXT TH    | 154.0 x 99.0 x 2.7  | 6.06 x 3.9 x 0.104    |
| 4207446                | FM6439          | CARBON PA | WAFFLE/PLAIN      | 60              | EXT TH    | 154.0 x 99.0 x 1.9  | 6.06 x 3.9 x 0.075    |
| 4207455                | FM6016MP        | STEEL     | -----             | 78              | EXT TH    | 200.0 x 114.0 x 2.3 | 7.87 x 4.49 x 0.089   |
| 4207620                | FM3658MP        | STEEL     | -----             | 54              | EXT TH    | 139.0 x 99.0 x 2.0  | 5.47 x 3.9 x 0.079    |
| 4207621                | FM6343          | PAPER     | WAFFLE            | 45              | INT TH    | 133.3 x 92.8 x 2.6  | 5.25 x 3.65 x 0.102   |
| 4208111                | FM6435          | CARBON PA | WAFFLE            | 52              | INT TH    | 193.0 x 107.5 x 2.6 | 7.6 x 4.23 x 0.102    |
| 4209872                | FM6999          | GRAPHITE  | SUNB/HARDENED     | 52              | INT TH    | 175.3 x 106.7 x 2.9 | 6.9 x 4.2 x 0.114     |
| 4210570                | FM6435          | CARBON PA | WAFFLE            | 52              | INT TH    | 193.0 x 107.5 x 2.6 | 7.6 x 4.23 x 0.102    |
| 4211245                | FM4998MP        | STEEL     | -----             | 45              | INT TH    | 133.0 x 92.7 x 2.0  | 5.24 x 3.65 x 0.079   |
| 4211394                | FM6437          | CARBON PA | WAFFLE            | 60              | EXT TH    | 154.0 x 99.0 x 2.7  | 6.06 x 3.9 x 0.104    |
| 4211395                | FM6439          | CARBON PA | WAFFLE/PLAIN      | 60              | EXT TH    | 154.0 x 99.0 x 1.9  | 6.06 x 3.9 x 0.075    |
| 4211499                | FM2737          | GRAPHITE  | SUNBURST          | 60              | INT TH    | 212.6 x 145.0 x 4.0 | 8.37 x 5.71 x 0.156   |
| 4211500                | FM2733          | GRAPHITE  | SUNBURST          | 72              | INT TH    | 244.2 x 175.5 x 4.0 | 9.62 x 6.91 x 0.156   |
| 4212130                | FM3696MP        | STEEL     | -----             | 60              | EXT TH    | 154.2 x 113.8 x 2.2 | 6.07 x 4.48 x 0.087   |
| 4213141                | FM8827          | CARBON PA | WAFFLE            | 52              | INT TH    | 148.6 x 107.6 x 3.0 | 5.85 x 4.24 x 0.118   |
| 4214248                | FM5376MP        | STEEL     | -----             | 45              | INT TH    | 148.3 x 92.7 x 2.3  | 5.84 x 3.65 x 0.089   |
| 4215359                | FM4995          | PAPER     | 2 PASS/PLAIN      | 54              | EXT TH    | 139.0 x 99.0 x 2.0  | 5.47 x 3.9 x 0.077    |
| 4215360                | FM4993          | PAPER     | 2 PASS            | 54              | EXT TH    | 139.0 x 99.0 x 2.7  | 5.47 x 3.9 x 0.104    |
| 4215606                | FM6435          | CARBON PA | WAFFLE            | 52              | INT TH    | 193.0 x 107.5 x 2.6 | 7.6 x 4.23 x 0.102    |
| 4215607                | FM6437          | CARBON PA | WAFFLE            | 60              | EXT TH    | 154.0 x 99.0 x 2.7  | 6.06 x 3.9 x 0.104    |
| 4215608                | FM6439          | CARBON PA | WAFFLE/PLAIN      | 60              | EXT TH    | 154.0 x 99.0 x 1.9  | 6.06 x 3.9 x 0.075    |
| 4220686                | FM6045          | PAPER     | WAFFLE            | 52              | INT TH    | 161.0 x 107.0 x 2.9 | 6.34 x 4.21 x 0.112   |
| 4220687                | FM6049          | PAPER     | WAFFLE            | 52              | EXT TH    | 167.5 x 114.0 x 2.6 | 6.59 x 4.49 x 0.102   |
| 4220895                | FM6051          | PAPER     | WAFFLE/PLAIN      | 52              | EXT TH    | 167.5 x 114.0 x 2.0 | 6.59 x 4.49 x 0.077   |
| 4324200                | FM5244MP        | STEEL     | HARDENED          | 54              | EXT TH    | 139.2 x 98.6 x 1.0  | 5.48 x 3.88 x 0.039   |
| 4344394                | FM5246MP        | OBSOLETE  | -----             | 51              | EXT TH    | 103.8 x 77.5 x 1.0  | 4.09 x 3.05 x 0.039   |
| 4345396                | FM4037          | PAPER     | 2 PASS            | 28              | INT TH    | 107.6 x 54.2 x 2.4  | 4.24 x 2.13 x 0.094   |

| REPLACES OEM PT.NO. |         | FMC PART NO. | MATERIAL  | GROOVE DETAILS | TEETH/TANGS | SIZE MM |       |   | SIZE INCH |   |     |       |   |       |   |       |
|---------------------|---------|--------------|-----------|----------------|-------------|---------|-------|---|-----------|---|-----|-------|---|-------|---|-------|
|                     | 7000727 | FM3648MP     | END PLATE | STEPPED        | 54          | EXT TH  | 139.2 | x | 98.6      | x | 9.0 | 5.48  | x | 3.88  | x | 0.354 |
|                     | 8027046 | FM3373       | PAPER     | 2 PASS         | 36          | INT TH  | 134.0 | x | 87.8      | x | 2.3 | 5.28  | x | 3.46  | x | 0.093 |
| <b>CLEARING</b>     |         |              |           |                |             |         |       |   |           |   |     |       |   |       |   |       |
|                     | A94693  | FM4904MP     | STEEL     | -----          | 110         | EXT TH  | 569.0 | x | 444.2     | x | 4.7 | 22.4  | x | 17.49 | x | 0.185 |
|                     | A94694  | FM4901       | BRONZE    | SPR/RAD        | 84          | INT TH  | 540.0 | x | 420.4     | x | 4.7 | 21.26 | x | 16.55 | x | 0.185 |
| <b>CLIMAX</b>       |         |              |           |                |             |         |       |   |           |   |     |       |   |       |   |       |
|                     | 106-136 | FM4646MP     | STEEL     | -----          | 12          | EXT TH  | 156.0 | x | 119.2     | x | 1.2 | 6.14  | x | 4.69  | x | 0.045 |
|                     | 106-138 | FM4643       | BRONZE    | SPR/RAD        | 24          | INT TH  | 143.0 | x | 109.8     | x | 1.6 | 5.63  | x | 4.32  | x | 0.061 |
|                     | 106-157 | FM4647       | BRONZE    | SPR/RAD        | 34          | INT TH  | 100.0 | x | 68.2      | x | 1.6 | 3.94  | x | 2.69  | x | 0.061 |
|                     | 106-158 | FM4650MP     | STEEL     | -----          | 24          | EXT TH  | 108.2 | x | 76.2      | x | 1.2 | 4.26  | x | 3     | x | 0.045 |
| <b>COLES CRANES</b> |         |              |           |                |             |         |       |   |           |   |     |       |   |       |   |       |
|                     | 8992283 | FM6844MP     | STEEL     | -----          | 50          | EXT TH  | 152.3 | x | 110.0     | x | 2.2 | 6.0   | x | 4.33  | x | 0.087 |
|                     | 8992294 | FM6845       | BRONZE    | SPR/RAD        | 35          | INT TH  | 146.0 | x | 102.5     | x | 3.0 | 4.57  | x | 4.04  | x | 0.118 |
| <b>CROWN</b>        |         |              |           |                |             |         |       |   |           |   |     |       |   |       |   |       |
|                     | 124776  | FM6366MP     | STEEL     | -----          | 28          | INT TH  | 200.0 | x | 53.8      | x | 8.5 | 7.87  | x | 2.12  | x | 0.335 |



| REPLACES OEM PT.NO. | FMC PART NO. | MATERIAL | GROOVE DETAILS | TEETH/TANGS | SIZE MM | SIZE INCH |
|---------------------|--------------|----------|----------------|-------------|---------|-----------|
|---------------------|--------------|----------|----------------|-------------|---------|-----------|

**DAEWOO / DOOSAN (also see ZF)**

|          |            |            |             |    |           |                     |                      |
|----------|------------|------------|-------------|----|-----------|---------------------|----------------------|
| 3T2567S  | FM3384MP   | STEEL      | -----       | 43 | (64)EX TH | 205.5 x 145.4 x 3.5 | 8.09 x 5.72 x 0.138  |
| 3T3400S  | FM3667     | PAPER      | 2 PASS      | 44 | INT TH    | 196.9 x 138.0 x 2.8 | 7.75 x 5.43 x 0.11   |
| 6T9456   | FM2448MP   | STEEL      | -----       | 60 | EXT TH    | 154.2 x 113.8 x 3.1 | 6.07 x 4.48 x 0.123  |
| 7T2742   | FM3382FP   | STEEL      | FLEXI PLATE | 6  | HOLE      | 339.7 x 133.4 x 1.5 | 13.37 x 5.25 x 0.059 |
| A153115  | FM5133     | BRONZE     | SUNBURST    | 65 | EXT TH    | 137.0 x 105.2 x 1.8 | 5.39 x 4.14 x 0.071  |
| A153116  | FM4782MP   | STEEL      | HARDENED    | 36 | INT TH    | 129.7 x 90.0 x 1.8  | 5.11 x 3.54 x 0.071  |
| A153155  | FM6851     | PAPER      | WAFFLE      | 36 | INT TH    | 130.0 x 90.0 x 2.6  | 5.12 x 3.54 x 0.102  |
| A153156  | FM6572MP   | STEEL      | -----       | 4  | EXT SL    | 172.0 x 100.0 x 1.5 | 6.77 x 3.94 x 0.059  |
| A188853  | FM6563     | PAPER      | 2 PASS      | 34 | INT TH    | 136.0 x 68.2 x 2.1  | 5.35 x 2.69 x 0.081  |
| A213070  | FM3138MP   | STEEL      | -----       | 24 | INT TH    | 122.0 x 60.0 x 3.0  | 4.8 x 2.36 x 0.118   |
| A213071  | FM3135     | PAPER      | WAFFLE      | 50 | EXT TH    | 128.9 x 80.0 x 2.3  | 5.07 x 3.15 x 0.091  |
| A213073  | FM3686MP   | STEEL      | -----       | 24 | INT TH    | 122.0 x 60.0 x 7.0  | 4.8 x 2.36 x 0.276   |
| A213498  | FM3684MP   | STEEL      | -----       | 24 | INT TH    | 122.0 x 60.0 x 5.0  | 4.8 x 2.36 x 0.197   |
| A233400  | FM6547OE   | PAPER      | WAFFLE      | 14 | INT TH    | 228.0 x 48.0 x 3.2  | 8.98 x 1.89 x 0.126  |
| A233400  | FM6547     | P206       | WAFFLE      | 14 | INT TH    | 228.0 x 48.0 x 3.2  | 8.98 x 1.89 x 0.126  |
| A243353  | FM4815     | GRAPHITE   | SUNBURST    | 36 | (73)EX TH | 151.5 x 101.5 x 3.5 | 5.96 x 4.0 x 0.138   |
| A243356  | FM4817     | GRAPH/STL  | SUN/PLAIN   | 36 | (73)EX TH | 151.5 x 101.5 x 2.8 | 5.96 x 4.0 x 0.108   |
| A243359  | FM2969     | BRONZE     | WAFFLE      | 22 | INT TH    | 71.7 x 44.0 x 1.6   | 2.82 x 1.73 x 0.063  |
| A250539  | FM4643     | BRONZE     | SPR/RAD     | 24 | INT TH    | 143.0 x 109.8 x 1.6 | 5.63 x 4.32 x 0.061  |
| A250596  | FM4646MP   | STEEL      | -----       | 12 | EXT TH    | 156.0 x 119.2 x 1.2 | 6.14 x 4.69 x 0.045  |
| A252423  | FM6361     | PAPER      | 2 PASS      | 22 | INT TH    | 185.5 x 53.3 x 3.2  | 7.3 x 2.1 x 0.126    |
| A252425  | FM6364MP   | STEEL      | -----       | 6  | EXT LG    | 212.5 x 115.8 x 2.5 | 8.37 x 4.56 x 0.096  |
| A273051  | FM2061     | PAPER      | WAFFLE      | 41 | INT TH    | 125.0 x 68.6 x 2.6  | 4.92 x 2.7 x 0.102   |
| A373219  | FM6841     | PAPER      | 2 PASS      | 41 | INT TH    | 125.0 x 68.6 x 2.7  | 4.92 x 2.7 x 0.106   |
| A373220  | FM1844MP   | STEEL      | -----       | 8  | EXT LG    | 134.4 x 81.0 x 1.6  | 5.29 x 3.19 x 0.063  |
| A403027  | FM6549     | PAPER      | 2 PASS      | 47 | INT TH    | 220.0 x 90.5 x 4.0  | 8.66 x 3.56 x 0.157  |
| A403028  | FM7246MP   | STEEL      | -----       | 3  | EXT SL    | 235.0 x 153.0 x 2.5 | 9.25 x 6.02 x 0.098  |
| A453374  | FM5967     | PAPER      | WAFFLE      | 40 | INT TH    | 119.7 x 79.0 x 1.6  | 4.71 x 3.11 x 0.063  |
| A453375  | FM7677     | CARBON PA  | WAFFLE      | 34 | INT TH    | 109.7 x 68.4 x 1.6  | 4.32 x 2.69 x 0.063  |
| A608549  | FM5244MP   | STEEL      | HARDENED    | 54 | EXT TH    | 139.2 x 98.6 x 1.0  | 5.48 x 3.88 x 0.039  |
| D141112  | FM3139     | PAPER      | WAFFLE      | 54 | INT TH    | 216.0 x 135.0 x 4.6 | 8.5 x 5.31 x 0.181   |
| D141113  | FM1279     | PAPER      | 2 PASS      | 52 | INT TH    | 148.6 x 107.7 x 1.8 | 5.85 x 4.24 x 0.07   |
| D161368  | FM3382FP   | STEEL      | FLEXI PLATE | 6  | HOLE      | 339.7 x 133.4 x 1.5 | 13.37 x 5.25 x 0.059 |
| D180320  | FM3650MP   | STEEL      | -----       | 54 | EXT TH    | 139.2 x 98.6 x 3.0  | 5.48 x 3.88 x 0.118  |
| D180339  | FM2829     | PAPER      | 2 PASS      | 45 | INT TH    | 133.1 x 92.7 x 2.1  | 5.24 x 3.65 x 0.083  |
| D700251  | FM3142MP   | STEEL      | -----       | 53 | EXT TH    | 226.0 x 142.9 x 2.5 | 8.9 x 5.63 x 0.098   |
| D700497  | FM3382FP   | STEEL      | FLEXI PLATE | 6  | HOLE      | 339.7 x 133.4 x 1.5 | 13.37 x 5.25 x 0.059 |
| K9000013 | FM4275     | CARBON PA  | RADIAL      | 64 | EXT TH    | 196.0 x 142.0 x 3.4 | 7.72 x 5.59 x 0.132  |
| K9000036 | FM4282MP   | STEEL      | -----       | 45 | INT TH    | 185.0 x 132.7 x 2.5 | 7.28 x 5.22 x 0.098  |
| K9000037 | FM4284MP   | STEEL      | -----       | 45 | INT TH    | 185.0 x 132.7 x 3.0 | 7.28 x 5.22 x 0.118  |
| K9000257 | FM4183     | PAPER      | WAF/WAG     | 64 | INT TH    | 345.0 x 252.1 x 4.7 | 13.58 x 9.93 x 0.185 |
| K9000258 | FM5247     | MOLYBDENUM | SPR/WAG     | 40 | INT TH    | 172.0 x 84.1 x 3.0  | 6.77 x 3.31 x 0.118  |
| K9000264 | FM5250-3.1 | STEEL      | HARDENED    | 4  | EXT LG    | 189.8 x 92.1 x 3.1  | 7.47 x 3.63 x 0.122  |
| K9000265 | FM5250-2.7 | STEEL      | HARDENED    | 4  | EXT LG    | 189.8 x 92.1 x 2.7  | 7.47 x 3.63 x 0.106  |
| K9000266 | FM5250-3.0 | STEEL      | HARDENED    | 4  | EXT LG    | 189.8 x 92.1 x 3.0  | 7.47 x 3.63 x 0.118  |
| K9000267 | FM5250-2.9 | STEEL      | HARDENED    | 4  | EXT LG    | 189.8 x 92.1 x 2.9  | 7.47 x 3.63 x 0.114  |
| K9000268 | FM5250-3.2 | STEEL      | HARDENED    | 4  | EXT LG    | 189.8 x 92.1 x 3.2  | 7.47 x 3.63 x 0.126  |

| REPLACES<br>OEM PT.NO. | FMC<br>PART NO. | MATERIAL    | GROOVE<br>DETAILS | TEETH/<br>TANGS | SIZE MM   |       |   |       | SIZE INCH |     |       |   |       |   |       |
|------------------------|-----------------|-------------|-------------------|-----------------|-----------|-------|---|-------|-----------|-----|-------|---|-------|---|-------|
| K9000270               | FM5250-3.3      | STEEL       | HARDENED          | 4               | EXT LG    | 189.8 | x | 92.1  | x         | 3.3 | 7.47  | x | 3.63  | x | 0.13  |
| K9000287               | FM4186MP        | STEEL       | -----             | 20              | EXT LG    | 372.5 | x | 262.5 | x         | 4.0 | 14.67 | x | 10.33 | x | 0.157 |
| K9000327               | FM5572MP        | STEEL       | -----             | 20              | EXT LG    | 372.5 | x | 262.5 | x         | 2.0 | 14.67 | x | 10.33 | x | 0.079 |
| K9000501               | FM2991          | PAPER       | 3 PASS            | 57              | INT TH    | 360.0 | x | 237.0 | x         | 4.5 | 14.17 | x | 9.33  | x | 0.177 |
| K9000525               | FM2995          | PAPER       | 2 PASS            | 54              | INT TH    | 325.0 | x | 224.0 | x         | 4.5 | 12.8  | x | 8.82  | x | 0.177 |
| K9000665               | FM4449          | MOLYBDENUM  | SPR/WAG           | 26              | INT TH    | 147.8 | x | 75.4  | x         | 3.0 | 5.82  | x | 2.97  | x | 0.118 |
| K9000746               | FM4666MP        | STEEL       | HARDENED          | 6               | EXT SL    | 130.0 | x | 66.8  | x         | 2.3 | 5.12  | x | 2.63  | x | 0.091 |
| K9000750               | FM4451          | MOLYBDENUM  | SPR/WAG           | 46              | (50)IN TH | 117.5 | x | 62.6  | x         | 2.6 | 4.63  | x | 2.46  | x | 0.102 |
| K9001542               | FM8432-2.0      | STEEL       | -----             | 31              | (40)IN TH | 208.0 | x | 119.0 | x         | 2.0 | 8.19  | x | 4.69  | x | 0.079 |
| K9001543               | FM8432-2.5      | STEEL       | -----             | 31              | (40)IN TH | 208.0 | x | 119.0 | x         | 2.5 | 8.19  | x | 4.69  | x | 0.098 |
| K9001585               | FM8049          | BRONZE      | WAF/WAG           | 34              | INT TH    | 104.0 | x | 68.0  | x         | 1.6 | 4.09  | x | 2.68  | x | 0.063 |
| K9001486               | FM8188MP        | STEEL       | HARDENED          | 45              | EXT TH    | 111.2 | x | 84.2  | x         | 1.4 | 4.38  | x | 3.31  | x | 0.055 |
| K9001887               | FM6417          | BRONZE      | WAF/WAG           | 64              | INT TH    | 345.0 | x | 252.0 | x         | 3.8 | 13.58 | x | 9.92  | x | 0.15  |
| K9001888               | FM6454MP        | STEEL       | HARDENED          | 20              | EXT LG    | 374.0 | x | 262.0 | x         | 2.4 | 14.72 | x | 10.31 | x | 0.094 |
| K9002025               | FM4286MP        | STEEL       | -----             | 45              | INT TH    | 185.0 | x | 132.7 | x         | 3.5 | 7.28  | x | 5.22  | x | 0.138 |
| K9002026               | FM4288MP        | STEEL       | -----             | 45              | INT TH    | 185.0 | x | 132.7 | x         | 4.0 | 7.28  | x | 5.22  | x | 0.157 |
| K9002702               | FM4183          | PAPER       | WAF/WAG           | 64              | INT TH    | 345.0 | x | 252.1 | x         | 4.7 | 13.58 | x | 9.93  | x | 0.185 |
| K9004084               | FM6715          | CARBON PA   | WAFFLE            | 8               | EXT LG    | 262.7 | x | 155.0 | x         | 4.5 | 10.34 | x | 6.1   | x | 0.177 |
| K9004158               | FM7132-2.5      | STEEL       | -----             | 36              | (48)IN TH | 236.0 | x | 144.2 | x         | 2.5 | 9.29  | x | 5.68  | x | 0.098 |
| K9004159               | FM7132-3.0      | STEEL       | -----             | 36              | (48)IN TH | 236.0 | x | 144.2 | x         | 3.0 | 9.29  | x | 5.68  | x | 0.118 |
| K9004160               | FM7132-2.0      | STEEL       | -----             | 36              | (48)IN TH | 236.0 | x | 144.2 | x         | 2.0 | 9.29  | x | 5.68  | x | 0.079 |
| K9004327               | FM6113          | PAPER/PLAIN | RADIAL            | 27              | EXT TH    | 137.0 | x | 93.7  | x         | 1.9 | 5.39  | x | 3.69  | x | 0.073 |
| K9004328               | FM6111          | CARBON PA   | RADIAL            | 27              | EXT TH    | 137.0 | x | 93.7  | x         | 2.5 | 5.39  | x | 3.69  | x | 0.098 |
| MX508790               | FM6522MP        | STEEL       | HARD/BLACK        | 45              | INT TH    | 170.0 | x | 132.7 | x         | 3.5 | 6.69  | x | 5.22  | x | 0.138 |
| MX508790               | FM4302MP        | STEEL       | -----             | 45              | INT TH    | 170.0 | x | 132.7 | x         | 3.5 | 6.69  | x | 5.22  | x | 0.138 |
| MX508791               | FM4296MP        | STEEL       | -----             | 45              | INT TH    | 170.0 | x | 132.7 | x         | 2.0 | 6.69  | x | 5.22  | x | 0.077 |
| MX508792               | FM6444MP        | STEEL       | HARD/BLACK        | 45              | INT TH    | 170.0 | x | 132.7 | x         | 2.5 | 6.69  | x | 5.22  | x | 0.098 |
| MX508792               | FM4298MP        | STEEL       | -----             | 45              | INT TH    | 170.0 | x | 132.7 | x         | 2.5 | 6.69  | x | 5.22  | x | 0.098 |
| MX508793               | FM6446MP        | STEEL       | HARD/BLACK        | 45              | INT TH    | 170.0 | x | 132.7 | x         | 3.0 | 6.69  | x | 5.22  | x | 0.118 |
| MX508795               | FM4289          | BRONZE      | SPR/RAD           | 35              | EXT TH    | 176.5 | x | 142.0 | x         | 2.5 | 6.95  | x | 5.51  | x | 0.096 |
| MX508796               | FM4291          | BRNZ/PLN    | SPR/RAD           | 35              | EXT TH    | 176.5 | x | 142.0 | x         | 2.0 | 6.95  | x | 5.51  | x | 0.077 |
| MX510818               | FM4399          | BRNZ/PLN    | SUNBURST          | 64              | EXT TH    | 196.0 | x | 142.0 | x         | 2.0 | 7.72  | x | 5.59  | x | 0.077 |
| 1021-666-005           | FM2829          | PAPER       | 2 PASS            | 45              | INT TH    | 133.1 | x | 92.7  | x         | 2.1 | 5.24  | x | 3.65  | x | 0.083 |
| 352-00014              | FM3398MP        | STEEL       | -----             | 12              | EXT LG    | 188.5 | x | 158.0 | x         | 1.5 | 7.42  | x | 6.22  | x | 0.059 |
| 355-00019              | FM4018MP        | OBSOLETE    | -----             | 75              | EXT TH    | 383.0 | x | 253.0 | x         | 2.5 | 15.08 | x | 9.96  | x | 0.098 |
| 355-00020              | FM4020MP        | STEEL       | -----             | 75              | EXT TH    | 383.0 | x | 253.0 | x         | 3.3 | 15.08 | x | 9.96  | x | 0.128 |
| 355-00022              | FM4024MP        | OBSOLETE    | -----             | 75              | EXT TH    | 345.0 | x | 243.0 | x         | 2.5 | 13.58 | x | 9.57  | x | 0.098 |
| 355-00023              | FM4026MP        | STEEL       | -----             | 75              | EXT TH    | 345.0 | x | 243.0 | x         | 3.3 | 13.58 | x | 9.57  | x | 0.128 |
| 412-00013              | FM3395          | ELASTOMER   | RADIAL            | 56              | (60)IN TH | 180.0 | x | 145.0 | x         | 4.0 | 7.09  | x | 5.71  | x | 0.157 |
| 1222-2001              | FM3460MP        | STEEL       | -----             | 12              | EXT SL    | 174.5 | x | 85.6  | x         | 1.8 | 6.87  | x | 3.37  | x | 0.071 |
| 1222-2018              | FM2330MP        | STEEL       | -----             | 12              | EXT SL    | 174.5 | x | 85.6  | x         | 1.8 | 6.87  | x | 3.37  | x | 0.071 |
| 1222-2019              | FM2273          | BRONZE      | SPR/WAG           | 32              | INT TH    | 146.1 | x | 78.5  | x         | 1.6 | 5.75  | x | 3.09  | x | 0.063 |
| 4355-7002              | FM5567          | PAPER       | 2 PASS            | 41              | INT TH    | 250.0 | x | 170.0 | x         | 4.5 | 9.84  | x | 6.69  | x | 0.177 |
| 4355-7004              | FM5570MP        | STEEL       | -----             | 77              | EXT TH    | 274.0 | x | 182.0 | x         | 4.0 | 10.79 | x | 7.17  | x | 0.157 |
| 4355-7010              | FM2995          | PAPER       | 2 PASS            | 54              | INT TH    | 325.0 | x | 224.0 | x         | 4.5 | 12.8  | x | 8.82  | x | 0.177 |
| 4355-7011              | FM3630MP        | STEEL       | -----             | 75              | EXT TH    | 345.0 | x | 243.0 | x         | 3.9 | 13.58 | x | 9.57  | x | 0.154 |
| 4355-7012              | FM3632MP        | STEEL       | -----             | 75              | EXT TH    | 345.0 | x | 243.0 | x         | 4.2 | 13.58 | x | 9.57  | x | 0.165 |
| 4355-7013              | FM3634MP        | STEEL       | -----             | 75              | EXT TH    | 345.0 | x | 243.0 | x         | 4.5 | 13.58 | x | 9.57  | x | 0.177 |

| REPLACES<br>OEM PT.NO. | FMC<br>PART NO. | MATERIAL    | GROOVE<br>DETAILS | TEETH/<br>TANGS | SIZE MM | SIZE INCH                                |
|------------------------|-----------------|-------------|-------------------|-----------------|---------|--|
| 4355-7014              | FM3636MP        | STEEL       | -----             | 75              | EXT TH  | 345.0 x 243.0 x 5.0 13.58 x 9.57 x 0.197 |
| 4355-7015              | FM2991          | PAPER       | 3 PASS            | 57              | INT TH  | 360.0 x 237.0 x 4.5 14.17 x 9.33 x 0.177 |
| 4355-7016              | FM3624MP        | STEEL       | -----             | 75              | EXT TH  | 383.0 x 253.0 x 4.5 15.08 x 9.96 x 0.177 |
| 4355-7017              | FM3622MP        | STEEL       | -----             | 75              | EXT TH  | 383.0 x 253.0 x 4.3 15.08 x 9.96 x 0.167 |
| 7123-32360             | FM5567          | PAPER       | 2 PASS            | 41              | INT TH  | 250.0 x 170.0 x 4.5 9.84 x 6.69 x 0.177  |
| 7124-22540             | FM3630MP        | STEEL       | -----             | 75              | EXT TH  | 345.0 x 243.0 x 3.9 13.58 x 9.57 x 0.154 |
| 7124-52500             | FM3624MP        | STEEL       | -----             | 75              | EXT TH  | 383.0 x 253.0 x 4.5 15.08 x 9.96 x 0.177 |
| 0501 208 435           | FM2815          | PAPER       | 4 PASS            | 42              | INT TH  | 340.0 x 206.0 x 5.5 13.39 x 8.11 x 0.217 |
| 0501 314 381           | FM3575          | PAPER       | 3 PASS            | 35              | INT TH  | 179.0 x 103.0 x 3.5 7.05 x 4.05 x 0.138  |
| 4474 308 082           | FM3610MP        | STEEL       | -----             | 91              | EXT TH  | 355.0 x 217.0 x 4.5 13.98 x 8.54 x 0.177 |
| 4474 308 083           | FM3612MP        | STEEL       | -----             | 91              | EXT TH  | 355.0 x 217.0 x 5.0 13.98 x 8.54 x 0.197 |
| 4474 308 084           | FM3614MP        | STEEL       | -----             | 91              | EXT TH  | 355.0 x 217.0 x 5.5 13.98 x 8.54 x 0.217 |
| 4645 251 022           | FM4643          | BRONZE      | SPR/RAD           | 24              | INT TH  | 143.0 x 109.8 x 1.6 5.63 x 4.32 x 0.061  |
| 4645 351 023           | FM4646MP        | STEEL       | -----             | 12              | EXT TH  | 156.0 x 119.2 x 1.2 6.14 x 4.69 x 0.045  |
| 4656 251 021           | FM4647          | BRONZE      | SPR/RAD           | 34              | INT TH  | 100.0 x 68.2 x 1.6 3.94 x 2.69 x 0.061   |
| 3146363                | FM2997          | PAPER       | 2 PASS            | 72              | INT TH  | 298.0 x 215.0 x 4.5 11.73 x 8.46 x 0.177 |
| 3146743                | FM2995          | PAPER       | 2 PASS            | 54              | INT TH  | 325.0 x 224.0 x 4.5 12.8 x 8.82 x 0.177  |
| 3146763                | FM2991          | PAPER       | 3 PASS            | 57              | INT TH  | 360.0 x 237.0 x 4.5 14.17 x 9.33 x 0.177 |
| 3146793                | FM3640MP        | STEEL       | -----             | 75              | EXT TH  | 315.0 x 226.0 x 3.9 12.4 x 8.9 x 0.154   |
| 3146803                | FM3644MP        | STEEL       | -----             | 75              | EXT TH  | 315.0 x 226.0 x 4.5 12.4 x 8.9 x 0.177   |
| 3146813                | FM3646MP        | STEEL       | -----             | 75              | EXT TH  | 315.0 x 226.0 x 5.0 12.4 x 8.9 x 0.197   |
| 3146823                | FM3630MP        | STEEL       | -----             | 75              | EXT TH  | 345.0 x 243.0 x 3.9 13.58 x 9.57 x 0.154 |
| 3146833                | FM3634MP        | STEEL       | -----             | 75              | EXT TH  | 345.0 x 243.0 x 4.5 13.58 x 9.57 x 0.177 |
| 3146843                | FM3636MP        | STEEL       | -----             | 75              | EXT TH  | 345.0 x 243.0 x 5.0 13.58 x 9.57 x 0.197 |
| 3146853                | FM3620MP        | STEEL       | -----             | 75              | EXT TH  | 383.0 x 253.0 x 3.9 15.08 x 9.96 x 0.154 |
| 3146863                | FM3624MP        | STEEL       | -----             | 75              | EXT TH  | 383.0 x 253.0 x 4.5 15.08 x 9.96 x 0.177 |
| 3146873                | FM3626MP        | STEEL       | -----             | 75              | EXT TH  | 383.0 x 253.0 x 5.0 15.08 x 9.96 x 0.197 |
| 3154543                | FM3642MP        | STEEL       | -----             | 75              | EXT TH  | 315.0 x 226.0 x 4.3 12.4 x 8.9 x 0.167   |
| 3200513                | FM3632MP        | STEEL       | -----             | 75              | EXT TH  | 345.0 x 243.0 x 4.2 13.58 x 9.57 x 0.165 |
| 3200523                | FM3622MP        | STEEL       | -----             | 75              | EXT TH  | 383.0 x 253.0 x 4.3 15.08 x 9.96 x 0.167 |
| 3243233                | FM2991          | PAPER       | 3 PASS            | 57              | INT TH  | 360.0 x 237.0 x 4.5 14.17 x 9.33 x 0.177 |
| 1.114-00173            | FM4284MP        | STEEL       | -----             | 45              | INT TH  | 185.0 x 132.7 x 3.0 7.28 x 5.22 x 0.118  |
| 1.114-00174            | FM4286MP        | STEEL       | -----             | 45              | INT TH  | 185.0 x 132.7 x 3.5 7.28 x 5.22 x 0.138  |
| 1.114-00175            | FM4288MP        | STEEL       | -----             | 45              | INT TH  | 185.0 x 132.7 x 4.0 7.28 x 5.22 x 0.157  |
| 1.222-00001            | FM4785          | PAPER/PLAIN | RADIAL            | 34              | EXT TH  | 177.4 x 111.5 x 1.9 6.98 x 4.39 x 0.075  |
| 1.222-00002            | FM4783          | CARBON PA   | RADIAL            | 34              | EXT TH  | 177.4 x 111.5 x 2.5 6.98 x 4.39 x 0.098  |
| 1.222-00003            | FM4789          | PAPER/PLAIN | RADIAL            | 44              | EXT TH  | 158.8 x 111.5 x 1.9 6.25 x 4.39 x 0.075  |
| 1.222-00004            | FM4787          | CARBON PA   | RADIAL            | 44              | EXT TH  | 158.8 x 111.5 x 2.5 6.25 x 4.39 x 0.098  |
| 1.222-00020            | FM3602MP        | STEEL       | -----             | 35              | INT TH  | 170.9 x 102.9 x 2.0 6.73 x 4.05 x 0.079  |
| 1.222-00021            | FM3604MP        | STEEL       | -----             | 35              | INT TH  | 170.9 x 102.9 x 2.5 6.73 x 4.05 x 0.098  |
| 1.222-00022            | FM3592MP        | STEEL       | -----             | 29              | INT TH  | 131.1 x 85.1 x 1.5 5.16 x 3.35 x 0.059   |
| 1.222-00023            | FM3594MP        | STEEL       | -----             | 29              | INT TH  | 131.1 x 85.1 x 2.0 5.16 x 3.35 x 0.079   |
| 1.222-00024            | FM3596MP        | STEEL       | -----             | 29              | INT TH  | 131.1 x 85.1 x 2.5 5.16 x 3.35 x 0.098   |
| 1.222-00042            | FM7038MP        | STEEL       | HARD/BLACK        | 64              | EXT TH  | 196.4 x 140.0 x 2.9 7.73 x 5.51 x 0.114  |
| 1.222-00025            | FM2279          | BRONZE      | SUNBURST          | 35              | EXT TH  | 177.5 x 109.0 x 2.0 6.99 x 4.29 x 0.079  |
| 1.222-00026            | FM2277          | BRONZE      | SUNBURST          | 27              | EXT TH  | 137.4 x 90.9 x 2.0 5.41 x 3.58 x 0.079   |
| 1.222-00028            | FM4786MP        | STEEL       | -----             | 42              | INT TH  | 167.8 x 102.5 x 2.5 6.61 x 4.04 x 0.098  |

| REPLACES OEM PT.NO. | FMC PART NO. | MATERIAL               | GROOVE DETAILS | TEETH/TANGS | SIZE MM    | SIZE INCH                                |
|---------------------|--------------|------------------------|----------------|-------------|------------|--|
| 1.222-00029         | FM4790MP     | STEEL                  | -----          | 42          | INT TH     | 150.9 x 102.5 x 2.5 5.94 x 4.04 x 0.098  |
| 1.222-00031         | FM4089       | PAPER                  | 3 PASS         | 48          | INT TH     | 232.7 x 142.0 x 4.0 9.16 x 5.59 x 0.157  |
| 1.222-00046         | FM4686MP     | STEEL                  | -----          | 81          | EXT TH     | 243.6 x 152.1 x 2.5 9.59 x 5.99 x 0.098  |
| 1.222-00048         | FM6896MP     | STEEL                  | -----          | 81          | EXT TH     | 243.6 x 152.1 x 2.0 9.59 x 5.99 x 0.079  |
| 2.114-00621         | FM4282MP     | STEEL                  | -----          | 45          | INT TH     | 185.0 x 132.7 x 2.5 7.28 x 5.22 x 0.098  |
| 2.114-00622         | FM4280MP     | STEEL                  | -----          | 45          | INT TH     | 185.0 x 132.7 x 2.0 7.28 x 5.22 x 0.077  |
| 2.222-00001         | FM5407       | MOLYBDENUM             | RADIAL         | 34          | INT TH     | 109.8 x 66.0 x 1.3 4.32 x 2.6 x 0.052    |
| 2.222-00002         | FM6922MP     | STEEL                  | HARDENED       | 4           | EXT LG     | 122.6 x 72.2 x 1.8 4.83 x 2.84 x 0.071   |
| 2.222-00003         | FM5409       | MOLYBDENUM/STEEL       | RADIAL         | 34          | INT TH     | 109.8 x 66.0 x 2.9 4.32 x 2.6 x 0.112    |
| 2.222-00012         | FM4625       | PAPER                  | SUNBURST       | 16          | INT TH     | 201.0 x 40.5 x 4.9 7.91 x 1.59 x 0.192   |
| 2.222-00013         | FM2344MP     | STEEL                  | -----          | 6           | EXT LG     | 220.0 x 145.5 x 2.7 8.66 x 5.73 x 0.105  |
| 2.222-00017         | FM2995       | PAPER                  | 2 PASS         | 54          | INT TH     | 325.0 x 224.0 x 4.5 12.8 x 8.82 x 0.177  |
| 2.222-00020         | FM7201       | USE FM4625 AFTER STOCK |                | 16          | INT TH     | 201.0 x 40.5 x 4.9 7.91 x 1.59 x 0.192   |
| 2.222-00029         | FM1324MP     | STEEL                  | -----          | 54          | EXT TH     | 139.2 x 98.6 x 1.8 5.48 x 3.88 x 0.07    |
| 2.222-00046         | FM4606MP     | STEEL                  | -----          | 3           | EXT LG     | 216.9 x 144.0 x 2.7 8.54 x 5.67 x 0.106  |
| 2.222-00047         | FM6781       | CARBON PA              | RADIAL         | 64          | EXT TH     | 196.0 x 142.0 x 2.6 7.72 x 5.59 x 0.1    |
| 2.222-00048         | FM6783       | CARBON PA              | RADIAL/PLAIN   | 64          | EXT TH     | 196.0 x 142.0 x 2.0 7.72 x 5.59 x 0.079  |
| 2.222-00080         | FM2815       | PAPER                  | 4 PASS         | 42          | INT TH     | 340.0 x 206.0 x 5.5 13.39 x 8.11 x 0.217 |
| 2.222-00082         | FM4298MP     | STEEL                  | -----          | 45          | INT TH     | 170.0 x 132.7 x 2.5 6.69 x 5.22 x 0.098  |
| 2.222-00083         | FM4300MP     | STEEL                  | -----          | 45          | INT TH     | 170.0 x 132.7 x 3.0 6.69 x 5.22 x 0.118  |
| 2.222-00084         | FM4302MP     | STEEL                  | -----          | 45          | INT TH     | 170.0 x 132.7 x 3.5 6.69 x 5.22 x 0.138  |
| 2.222-00085         | FM4304MP     | STEEL                  | -----          | 45          | INT TH     | 170.0 x 132.7 x 4.0 6.69 x 5.22 x 0.157  |
| 2.222-00086         | FM2890MP     | STEEL                  | -----          | 3           | EXT LG     | 180.0 x 111.0 x 2.7 7.09 x 4.37 x 0.105  |
| 2.222-00087         | FM8595       | CARBON PA              | RADIAL         | 35          | EXT TH     | 176.5 x 142.0 x 2.5 6.95 x 5.51 x 0.096  |
| 2.222-00088         | FM8597       | CARBON PA              | RADIAL/PLAIN   | 35          | EXT TH     | 176.5 x 142.0 x 1.9 6.95 x 5.51 x 0.073  |
| 2.222-00089         | FM3610MP     | STEEL                  | -----          | 91          | EXT TH     | 355.0 x 217.0 x 4.5 13.98 x 8.54 x 0.177 |
| 2.222-00090         | FM3612MP     | STEEL                  | -----          | 91          | EXT TH     | 355.0 x 217.0 x 5.0 13.98 x 8.54 x 0.197 |
| 2.222-00091         | FM3614MP     | STEEL                  | -----          | 91          | EXT TH     | 355.0 x 217.0 x 5.5 13.98 x 8.54 x 0.217 |
| 130106-00001        | FM6549       | PAPER                  | 2 PASS         | 47          | INT TH     | 220.0 x 90.5 x 4.0 8.66 x 3.56 x 0.157   |
| 130106-00022        | FM4625       | PAPER                  | SUNBURST       | 16          | INT TH     | 201.0 x 40.5 x 4.9 7.91 x 1.59 x 0.192   |
| 130106-00063        | FM4289       | BRONZE                 | SPR/RAD        | 35          | EXT TH     | 176.5 x 142.0 x 2.5 6.95 x 5.51 x 0.096  |
| 130107-00003        | FM8429       | CARBON PA              | WAFFLE         | 8           | EXT LG     | 240.0 x 140.0 x 4.5 9.45 x 5.51 x 0.177  |
| 130107-00037        | FM9145       | BRONZE                 | WAF/WAG        | 78          | INT TH     | 445.5 x 312.3 x 4.0 17.54 x 12.3 x 0.157 |
| <b>DAF</b>          |              |                        |                |             |            |  |
| 1342752             | FM9354MP     | STEEL                  | -----          | 8           | EXT LG     | 161.6 x 107.0 x 1.8 6.36 x 4.21 x 0.071  |
| 1342753             | FM9351       | CARBON PA              | 2 PASS         | 34          | INT TH     | 146.7 x 99.7 x 2.1 5.78 x 3.93 x 0.083   |
| <b>DAIMLER</b>      |              |                        |                |             |            |  |
| 554179              | FM0709       | OBSOLETE               | RADIAL         | 82          | EXT TH     | 213.4 x 142.2 x 3.2 8.4 x 5.6 x 0.125    |
| 25C132098           | FM0709       | OBSOLETE               | RADIAL         | 82          | EXT TH     | 213.4 x 142.2 x 3.2 8.4 x 5.6 x 0.125    |
| 25271543            | FM1550MP     | OBSOLETE               | -----          | 52          | INT TH     | 197.9 x 127.0 x 3.2 7.79 x 5.0 x 0.125   |
| <b>DANFOSS</b>      |              |                        |                |             |            |  |
| 1545967             | FM6823       | BRONZE                 | WAFFLE         | 24          | (27) IN TH | 88.0 x 53.2 x 1.6 3.46 x 2.09 x 0.063    |
| 154B2832            | FM6826MP     | STEEL                  | HARD/BLACK     | 6           | EXT LG     | 99.7 x 60.3 x 1.5 3.93 x 2.37 x 0.059    |
| 154B2833            | FM5863       | BRONZE                 | WAFFLE         | 6           | EXT LG     | 123.7 x 72.0 x 1.5 4.87 x 2.83 x 0.059   |
| 154B5970            | FM5978MP     | STEEL                  | -----          | 19          | INT TH     | 107.0 x 62.5 x 1.5 4.21 x 2.46 x 0.059   |

| REPLACES<br>OEM PT.NO. | FMC<br>PART NO. | MATERIAL | GROOVE<br>DETAILS | TEETH/<br>TANGS | SIZE MM   |       |   | SIZE INCH |   |      |       |   |      |   |       |
|------------------------|-----------------|----------|-------------------|-----------------|-----------|-------|---|-----------|---|------|-------|---|------|---|-------|
| <b>DANTRUCK</b>        |                 |          |                   |                 |           |       |   |           |   |      |       |   |      |   |       |
| 9217039                | FM2777          | GRAPHITE | SUNBURST          | 27              | INT TH    | 260.0 | x | 66.1      | x | 10.0 | 10.24 | x | 2.6  | x | 0.394 |
| <b>DEUTZ</b>           |                 |          |                   |                 |           |       |   |           |   |      |       |   |      |   |       |
| 4416412                | FM9063          | BRONZE   | SUNBURST          | 27              | EXT TH    | 137.4 | x | 90.9      | x | 2.0  | 5.41  | x | 3.58 | x | 0.079 |
| 4416413                | FM3594MP        | STEEL    | -----             | 29              | INT TH    | 131.1 | x | 85.1      | x | 2.0  | 5.16  | x | 3.35 | x | 0.079 |
| 4416760                | FM8329          | BRONZE   | SUNBURST          | 30              | EXT TH    | 118.3 | x | 77.3      | x | 2.2  | 4.66  | x | 3.04 | x | 0.087 |
| 4416795                | FM7692MP        | STEEL    | SINEWAVED         | 47              | (48)IN TH | 198.0 | x | 131.6     | x | 2.8  | 7.8   | x | 5.18 | x | 0.11  |
| 4416967                | FM8332MP        | STEEL    | -----             | 36              | INT TH    | 110.9 | x | 70.7      | x | 1.5  | 4.37  | x | 2.78 | x | 0.059 |
| 4417527                | FM5207          | PAPER    | WAFFLE            | 28              | INT TH    | 223.0 | x | 56.0      | x | 4.4  | 8.78  | x | 2.2  | x | 0.173 |
| 4417528                | FM5210MP        | STEEL    | -----             | 2               | EXT LG    | 253.0 | x | 150.0     | x | 2.6  | 9.96  | x | 5.91 | x | 0.102 |
| 4417601                | FM8592MP        | STEEL    | HARDENED          | 41              | INT TH    | 177.7 | x | 119.5     | x | 2.0  | 7.0   | x | 4.7  | x | 0.079 |
| 4417633                | FM8589          | BRONZE   | SUNBURST          | 6               | EXT LG    | 193.7 | x | 136.3     | x | 3.0  | 7.63  | x | 5.37 | x | 0.098 |
| 4419769                | FM7689          | PAPER    | WAFFLE            | 10              | EXT LG    | 211.0 | x | 149.4     | x | 2.5  | 8.31  | x | 5.88 | x | 0.098 |
| 4426602                | FM8483          | GRAPHITE | SUNBURST          | 28              | INT TH    | 242.6 | x | 56.1      | x | 4.8  | 9.55  | x | 2.21 | x | 0.189 |
| 4433619                | FM7688MP        | STEEL    | SINEWAVED         | 40              | (41)IN TH | 233.0 | x | 160.2     | x | 2.8  | 9.17  | x | 6.31 | x | 0.11  |
| 4434228                | FM3592MP        | STEEL    | -----             | 29              | INT TH    | 131.1 | x | 85.1      | x | 1.5  | 5.16  | x | 3.35 | x | 0.059 |
| 4434229                | FM3596MP        | STEEL    | -----             | 29              | INT TH    | 131.1 | x | 85.1      | x | 2.5  | 5.16  | x | 3.35 | x | 0.098 |
| G001990200370          | FM7685          | PAPER    | WAFFLE            | 12              | EXT LG    | 252.7 | x | 180.6     | x | 2.5  | 9.95  | x | 7.11 | x | 0.098 |
| 0.900.0019.3           | FM8589          | BRONZE   | SUNBURST          | 6               | EXT LG    | 193.7 | x | 136.3     | x | 3.0  | 7.63  | x | 5.37 | x | 0.098 |
| 0.900.0116.1           | FM9485          | GRAPHITE | SUNBURST          | 12              | INT TH    | 170.0 | x | 32.7      | x | 4.8  | 6.69  | x | 1.29 | x | 0.189 |
| 0.900.0504.0           | FM3095          | GRAPHITE | SUNBURST          | 13              | INT TH    | 215.0 | x | 36.5      | x | 10.0 | 8.46  | x | 1.44 | x | 0.394 |
| 0.900.0706.1           | FM2971          | BRONZE   | WAFFLE            | 22              | INT TH    | 71.7  | x | 44.0      | x | 2.8  | 2.82  | x | 1.73 | x | 0.11  |
| 0.900.0706.2           | FM3474MP        | STEEL    | -----             | 4               | EXT LG    | 85.0  | x | 49.2      | x | 1.5  | 3.35  | x | 1.94 | x | 0.059 |
| 0.900.0706.3           | FM2969          | BRONZE   | WAFFLE            | 22              | INT TH    | 71.7  | x | 44.0      | x | 1.6  | 2.82  | x | 1.73 | x | 0.063 |
| 0.900.0801.2           | FM8483          | GRAPHITE | SUNBURST          | 28              | INT TH    | 242.6 | x | 56.1      | x | 4.8  | 9.55  | x | 2.21 | x | 0.189 |
| 0.900.0801.3           | FM7274MP        | STEEL    | -----             | 2               | EXT LG    | 288.0 | x | 156.0     | x | 3.0  | 11.34 | x | 6.14 | x | 0.118 |
| 0.900.0946.6           | FM7714MP        | STEEL    | -----             | 2               | EXT LG    | 248.0 | x | 156.0     | x | 5.0  | 9.76  | x | 6.14 | x | 0.197 |
| 0.900.1163.2           | FM7711          | PAPER    | WAFFLE            | 36              | INT TH    | 242.5 | x | 72.0      | x | 5.2  | 9.55  | x | 2.83 | x | 0.205 |
| 0.900.1362.9           | FM9155          | PAPER    | WAFFLE            | 50              | EXT TH    | 204.7 | x | 149.0     | x | 2.5  | 8.06  | x | 5.87 | x | 0.098 |
| 0.900.1377.2           | FM8592MP        | STEEL    | HARDENED          | 41              | INT TH    | 177.7 | x | 119.5     | x | 2.0  | 7.0   | x | 4.7  | x | 0.079 |
| <b>DITCH WITCH</b>     |                 |          |                   |                 |           |       |   |           |   |      |       |   |      |   |       |
| 501-890                | FM2971          | BRONZE   | WAFFLE            | 22              | INT TH    | 71.7  | x | 44.0      | x | 2.8  | 2.82  | x | 1.73 | x | 0.11  |
| 501-891                | FM2969          | BRONZE   | WAFFLE            | 22              | INT TH    | 71.7  | x | 44.0      | x | 1.6  | 2.82  | x | 1.73 | x | 0.063 |
| 501-891                | FM3474MP        | STEEL    | -----             | 4               | EXT LG    | 85.0  | x | 49.2      | x | 1.5  | 3.35  | x | 1.94 | x | 0.059 |
| <b>DONGI MARINE</b>    |                 |          |                   |                 |           |       |   |           |   |      |       |   |      |   |       |
| 170107                 | FM5079          | BRONZE   | SUNBURST          | 93              | EXT TH    | 142.3 | x | 94.0      | x | 2.5  | 5.6   | x | 3.7  | x | 0.098 |
| 170108                 | FM5082MP        | STEEL    | -----             | 56              | INT TH    | 134.0 | x | 81.2      | x | 2.0  | 5.27  | x | 3.2  | x | 0.078 |

| REPLACES<br>OEM PT.NO. | FMC<br>PART NO. | MATERIAL  | GROOVE<br>DETAILS | TEETH/<br>TANGS | SIZE MM   | SIZE INCH                                 |
|------------------------|-----------------|-----------|-------------------|-----------------|-----------|---|
| <b>DRESSER</b>         |                 |           |                   |                 |           |   |
| PB7600-2               | FM2661          | PAPER     | 3 PASS            | 166             | INT TH    | 659.9 x 492.0 x 5.1 25.98 x 19.37 x 0.2   |
| PB7601-2               | FM2674MP        | STEEL     | -----             | 226             | EXT TH    | 681.0 x 509.8 x 2.4 26.81 x 20.07 x 0.094 |
| PB7602-2               | FM2675          | CORK      | -----             | 226             | EXT TH    | 681.0 x 509.8 x 6.9 26.81 x 20.07 x 0.27  |
| <b>DRESSTA</b>         |                 |           |                   |                 |           |   |
| 325-01-0047            | FM6517          | BRONZE    | SPR/RAD           | 24              | INT TH    | 193.5 x 101.3 x 4.0 7.62 x 3.99 x 0.157   |
| 325-01-1369            | FM6520MP        | STEEL     | -----             | 34              | (46)EX TH | 216.0 x 119.0 x 2.7 8.5 x 4.69 x 0.104    |
| 376-04-1004            | FM4528MP        | STEEL     | RUBBER PINS       | 8               | EXT LG    | 244.0 x 173.0 x 3.2 9.61 x 6.81 x 0.126   |
| 386-07-0117            | FM1249          | GRAPHITE  | SUNBURST          | 34              | INT TH    | 198.1 x 140.5 x 2.5 7.8 x 5.53 x 0.098    |
| 386-07-0123            | FM1251          | GRAPHITE  | SUNBURST          | 45              | INT TH    | 266.7 x 187.2 x 2.8 10.5 x 7.37 x 0.11    |
| 386-07-1033            | FM1742MP        | STEEL     | -----             | 41              | EXT TH    | 210.1 x 152.4 x 2.1 8.27 x 6.0 x 0.083    |
| 386-07-1066            | FM1744MP        | STEEL     | -----             | 54              | EXT TH    | 276.0 x 200.7 x 2.3 10.87 x 7.9 x 0.09    |
| 395-07-0131            | FM6801          | CARBON    | SUNBURST          | 39              | INT TH    | 228.1 x 161.8 x 2.8 8.98 x 6.37 x 0.112   |
| 395-07-0133            | FM6799          | OBSOLETE  | SUNBURST          | 36              | INT TH    | 316.0 x 222.5 x 2.8 12.44 x 8.76 x 0.112  |
| 395-07-0261            | FM5892MP        | STEEL     | RUBBER PINS       | 8               | EXT LG    | 329.0 x 240.0 x 2.4 12.95 x 9.45 x 0.093  |
| 395-07-1212            | FM5888MP        | STEEL     | HARDENED          | 8               | EXT LG    | 247.0 x 173.0 x 2.4 9.72 x 6.81 x 0.093   |
| 395-07-1213            | FM5890MP        | STEEL     | HARDENED          | 8               | EXT LG    | 247.0 x 173.0 x 2.4 9.72 x 6.81 x 0.093   |
| 576-07-1105            | FM6071          | BRONZE    | SUNBURST          | 48              | INT TH    | 162.0 x 120.0 x 2.6 6.38 x 4.72 x 0.102   |
| 585-07-0255            | FM5886MP        | STEEL     | RUBBER PINS       | 6               | EXT LG    | 437.0 x 343.0 x 2.4 17.2 x 13.5 x 0.093   |
| 588-07-0255            | FM2268MP        | STEEL     | -----             | 6               | EXT LG    | 438.2 x 342.9 x 2.3 17.25 x 13.5 x 0.09   |
| 588-32-1011            | FM5954MP        | STEEL     | -----             | 6               | EXT LG    | 198.2 x 133.4 x 2.3 7.8 x 5.25 x 0.091    |
| 778-32-0201            | FM6069          | OBSOLETE  | WAFFLE            | 36              | INT TH    | 316.0 x 222.5 x 4.3 12.44 x 8.76 x 0.168  |
| 852-011-352            | FM2828MP        | STEEL     | -----             | 6               | EXT LG    | 151.0 x 98.0 x 2.5 5.94 x 3.86 x 0.098    |
| 852-04-1335            | FM2823          | PAPER     | 2 PASS            | 36              | INT TH    | 223.0 x 71.0 x 4.9 8.78 x 2.8 x 0.191     |
| 852-04-1336            | FM3912MP        | END PLATE | -----             | 64              | EXT TH    | 230.0 x 152.5 x 5.0 9.06 x 6.0 x 0.197    |
| 852-05-0120            | FM5971          | OBSOLETE  |                   |                 |           |   |
| 852-05-0121            | FM1251          | GRAPHITE  | SUNBURST          | 45              | INT TH    | 266.7 x 187.2 x 2.8 10.5 x 7.37 x 0.11    |
| 852-12-1353            | FM2825          | BRONZE    | SUNBURST          | 45              | INT TH    | 133.0 x 93.0 x 1.8 5.24 x 3.66 x 0.069    |
| <b>DYNAHOE</b>         |                 |           |                   |                 |           |   |
| 62901014               | FM3650MP        | STEEL     | -----             | 54              | EXT TH    | 139.2 x 98.6 x 3.0 5.48 x 3.88 x 0.118    |
| 62901015               | FM2829          | PAPER     | 2 PASS            | 45              | INT TH    | 133.1 x 92.7 x 2.1 5.24 x 3.65 x 0.083    |
| <b>DYNAPAC</b>         |                 |           |                   |                 |           |   |
| 421231                 | FM3935          | BRONZE    | SPR/RAD           | 6               | EXT LG    | 122.0 x 72.0 x 2.4 4.8 x 2.83 x 0.094     |
| 49600254               | FM5352MP        | STEEL     | -----             | 37              | EXT TH    | 75.5 x 57.2 x 1.1 2.97 x 2.25 x 0.042     |
| 49600255               | FM5349          | BRONZE    | WAFFLE            | 27              | INT TH    | 71.1 x 52.7 x 1.7 2.8 x 2.07 x 0.065      |
| 4700939027             | FM4625          | PAPER     | SUNBURST          | 16              | INT TH    | 201.0 x 40.5 x 4.9 7.91 x 1.59 x 0.192    |
| 4700939033             | FM4606MP        | STEEL     | -----             | 3               | EXT LG    | 216.9 x 144.0 x 2.7 8.54 x 5.67 x 0.106   |

| REPLACES<br>OEM PT.NO.                       | FMC<br>PART NO. | MATERIAL             | GROOVE<br>DETAILS | TEETH/<br>TANGS | SIZE MM   |        |   | SIZE INCH |   |     |       |   |       |   |       |
|--|-----------------|----------------------|-------------------|-----------------|-----------|--------|---|-----------|---|-----|-------|---|-------|---|-------|
| <b>EDER</b>                                  |                 |                      |                   |                 |           |        |   |           |   |     |       |   |       |   |       |
| 711207                                       | FM4647          | BRONZE               | SPR/RAD           | 34              | INT TH    | 100.0  | x | 68.2      | x | 1.6 | 3.94  | x | 2.69  | x | 0.061 |
| 711208                                       | FM4650MP        | STEEL                | -----             | 24              | EXT TH    | 108.2  | x | 76.2      | x | 1.2 | 4.26  | x | 3.0   | x | 0.045 |
| 711759                                       | FM3575          | PAPER                | 3 PASS            | 35              | INT TH    | 179.0  | x | 103.0     | x | 3.5 | 7.05  | x | 4.05  | x | 0.138 |
| <b>EUCLID (also see ALLISON and HITACHI)</b> |                 |                      |                   |                 |           |        |   |           |   |     |       |   |       |   |       |
| 209929                                       | FM0123          | OBSOLETE AFTER STOCK |                   | 24              | INT TH    | 187.5  | x | 95.3      | x | 4.0 | 7.38  | x | 3.75  | x | 0.157 |
| 216050                                       | FM3467          | BRONZE               | SUNBURST          | 34              | INT TH    | 205.0  | x | 114.8     | x | 3.9 | 8.07  | x | 4.52  | x | 0.154 |
| 222173                                       | FM3428MP        | STEEL                | -----             | 17              | (34)EX TH | 225.0  | x | 133.6     | x | 2.7 | 8.86  | x | 5.26  | x | 0.106 |
| 232395                                       | FM2758MP        | STEEL                | -----             | 21              | (28)EX TH | 314.2  | x | 227.3     | x | 2.6 | 12.37 | x | 8.95  | x | 0.102 |
| 242716                                       | FM2737          | GRAPHITE             | SUNBURST          | 60              | INT TH    | 212.6  | x | 145.0     | x | 4.0 | 8.37  | x | 5.71  | x | 0.156 |
| 242717                                       | FM1960MP        | STEEL                | -----             | 35              | EXT TH    | 228.1  | x | 159.0     | x | 2.7 | 8.98  | x | 6.26  | x | 0.105 |
| 1528774                                      | FM2620MP        | STEEL                | -----             | 14              | EXT TH    | 244.6  | x | 182.9     | x | 2.6 | 9.63  | x | 7.2   | x | 0.103 |
| 1528786                                      | FM2618MP        | STEEL                | -----             | 16              | EXT TH    | 335.0  | x | 273.1     | x | 2.6 | 13.19 | x | 10.75 | x | 0.103 |
| 1528787                                      | FM2622MP        | STEEL                | -----             | 16              | EXT TH    | 335.0  | x | 272.9     | x | 3.0 | 13.19 | x | 10.75 | x | 0.12  |
| 2108352                                      | FM1723          | GRAPHITE             | SUNBURST          | 36              | INT TH    | 394.5  | x | 222.3     | x | 6.2 | 15.53 | x | 8.75  | x | 0.245 |
| 4050720                                      | FM1181          | GRAPHITE             | SUNBURST          | 62              | INT TH    | 319.0  | x | 259.1     | x | 3.8 | 12.56 | x | 10.2  | x | 0.148 |
| 4050728                                      | FM1311          | GRAPHITE             | SUNBURST          | 73              | INT TH    | 371.3  | x | 303.0     | x | 5.2 | 14.62 | x | 11.93 | x | 0.205 |
| 4050741                                      | FM1179          | GRAPHITE             | SUNBURST          | 60              | INT TH    | 253.7  | x | 187.5     | x | 3.9 | 9.99  | x | 7.38  | x | 0.153 |
| 4058551                                      | FM1177          | GRAPHITE             | SUNBURST          | 72              | INT TH    | 371.3  | x | 303.0     | x | 5.2 | 14.62 | x | 11.93 | x | 0.205 |
| 4058554                                      | FM1243          | GRAPHITE             | SUNBURST          | 73              | INT TH    | 371.3  | x | 303.0     | x | 5.2 | 14.62 | x | 11.93 | x | 0.205 |
| 4095205                                      | FM1278MP        | STEEL                | -----             | 14              | (20)EX TH | 218.9  | x | 158.8     | x | 2.7 | 8.62  | x | 6.25  | x | 0.106 |
| 4095206                                      | FM1195          | BRONZE               | SUNBURST          | 60              | INT TH    | 195.1  | x | 145.0     | x | 4.0 | 7.68  | x | 5.71  | x | 0.156 |
| 4095310                                      | FM1218MP        | STEEL                | -----             | 16              | (24)EX TH | 257.2  | x | 190.5     | x | 2.7 | 10.13 | x | 7.5   | x | 0.106 |
| 4095311                                      | FM1193          | GRAPHITE             | SUNBURST          | 72              | INT TH    | 233.4  | x | 175.5     | x | 4.0 | 9.19  | x | 6.91  | x | 0.156 |
| EU4059006                                    | FM2172MP        | STEEL                | -----             | 20              | EXT TH    | 670.6  | x | 468.4     | x | 3.1 | 26.4  | x | 18.44 | x | 0.122 |
| EU4059008                                    | FM2173          | PAPER                | 3 PASS            | 52              | INT TH    | 648.0  | x | 432.6     | x | 5.2 | 25.51 | x | 17.03 | x | 0.205 |
| 6830293                                      | FM1417          | CARBON PA            | SUNBURST          | 57              | INT TH    | 303.8  | x | 235.2     | x | 3.9 | 11.96 | x | 9.26  | x | 0.153 |
| 12577948                                     | FM3270MP        | STEEL                | -----             | 84              | EXT TH    | 863.9  | x | 606.6     | x | 3.0 | 34.01 | x | 23.88 | x | 0.118 |
| 12579204                                     | FM3271          | CORK                 | -----             | 84              | EXT TH    | 863.9  | x | 606.6     | x | 7.4 | 34.01 | x | 23.88 | x | 0.29  |
| 12579870                                     | FM3267          | PAPER                | 3 PASS            | 84              | INT TH    | 830.1  | x | 558.8     | x | 5.6 | 32.68 | x | 22.0  | x | 0.22  |
| 12612897                                     | FM8289          | CARBON PA            | 3 PASS            | 112             | INT TH    | 1069.0 | x | 750.0     | x | 5.5 | 42.09 | x | 29.53 | x | 0.217 |
| 12613548                                     | FM8292MP        | STEEL                | -----             | 108             | EXT TH    | 1102.4 | x | 806.7     | x | 4.5 | 43.4  | x | 31.76 | x | 0.177 |
| 12613550                                     | FM8293          | CORK                 | -----             | 108             | EXT TH    | 1102.4 | x | 806.7     | x | 9.0 | 43.4  | x | 31.76 | x | 0.354 |
| 12671032                                     | FM3270MP        | STEEL                | -----             | 84              | EXT TH    | 863.9  | x | 606.6     | x | 3.0 | 34.01 | x | 23.88 | x | 0.118 |
| 12671034                                     | FM3267          | PAPER                | 3 PASS            | 84              | INT TH    | 830.1  | x | 558.8     | x | 5.6 | 32.68 | x | 22.0  | x | 0.22  |

| REPLACES OEM PT.NO. | FMC PART NO. | MATERIAL | GROOVE DETAILS | TEETH/TANGS | SIZE MM | SIZE INCH |
|---------------------|--------------|----------|----------------|-------------|---------|-----------|
|---------------------|--------------|----------|----------------|-------------|---------|-----------|

### F&S

|                  |          |        |         |    |        |       |   |       |   |     |       |   |       |   |       |
|------------------|----------|--------|---------|----|--------|-------|---|-------|---|-----|-------|---|-------|---|-------|
| 0787-035-500     | FM4869   | AFP    | 3 PASS  | 66 | INT TH | 378.0 | x | 326.0 | x | 3.1 | 14.88 | x | 12.83 | x | 0.12  |
| Torque Converter | FM3777   | BRONZE | SPIRAL  | 71 | INT TH | 393.0 | x | 350.0 | x | 3.3 | 15.47 | x | 13.78 | x | 0.13  |
| Torque Converter | FM3780MP | STEEL  | -----   | 80 | EXT TH | 402.0 | x | 363.0 | x | 2.0 | 15.83 | x | 14.29 | x | 0.079 |
| Torque Converter | FM5143   | BRONZE | SPR/RAD | 53 | INT TH | 302.8 | x | 261.1 | x | 3.3 | 11.92 | x | 10.28 | x | 0.13  |
| Torque Converter | FM5146MP | STEEL  | -----   | 62 | EXT TH | 312.2 | x | 272.0 | x | 2.0 | 12.29 | x | 10.71 | x | 0.079 |

### FAI (KOMATSU)

|           |          |           |          |    |           |       |   |       |   |      |       |   |      |   |       |
|-----------|----------|-----------|----------|----|-----------|-------|---|-------|---|------|-------|---|------|---|-------|
| CA0110642 | FM2971   | BRONZE    | WAFFLE   | 22 | INT TH    | 71.7  | x | 44.0  | x | 2.8  | 2.82  | x | 1.73 | x | 0.11  |
| CA0110643 | FM3474MP | STEEL     | -----    | 4  | EXT LG    | 85.0  | x | 49.2  | x | 1.5  | 3.35  | x | 1.94 | x | 0.059 |
| CA0110644 | FM2969   | BRONZE    | WAFFLE   | 22 | INT TH    | 71.7  | x | 44.0  | x | 1.6  | 2.82  | x | 1.73 | x | 0.063 |
| CA0119363 | FM4015   | GRAPHITE  | SUNBURST | 27 | INT TH    | 303.8 | x | 66.1  | x | 10.0 | 11.96 | x | 2.6  | x | 0.393 |
| CA0119682 | FM2777   | GRAPHITE  | SUNBURST | 27 | INT TH    | 260.0 | x | 66.1  | x | 10.0 | 10.24 | x | 2.6  | x | 0.394 |
| CA0121656 | FM2781   | GRAPHITE  | SUNBURST | 15 | INT TH    | 213.0 | x | 44.0  | x | 10.0 | 8.38  | x | 1.73 | x | 0.394 |
| CA0132690 | FM3351   | GRAPHITE  | SUNBURST | 36 | INT TH    | 272.0 | x | 71.1  | x | 4.9  | 10.71 | x | 2.8  | x | 0.193 |
| CA0133924 | FM2828MP | STEEL     | -----    | 6  | EXT LG    | 151.0 | x | 98.0  | x | 2.5  | 5.94  | x | 3.86 | x | 0.098 |
| CA0133972 | FM2825   | BRONZE    | SUNBURST | 45 | INT TH    | 133.0 | x | 93.0  | x | 1.8  | 5.24  | x | 3.66 | x | 0.069 |
| CA0134740 | FM3910MP | END PLATE | -----    | 64 | EXT TH    | 230.0 | x | 151.0 | x | 9.0  | 9.06  | x | 5.94 | x | 0.354 |
| CA0136112 | FM2823   | PAPER     | 2 PASS   | 36 | INT TH    | 223.0 | x | 71.0  | x | 4.9  | 8.78  | x | 2.8  | x | 0.191 |
| CA0136139 | FM5420MP | STEEL     | -----    | 32 | (80)EX TH | 282.0 | x | 207.5 | x | 5.0  | 11.1  | x | 8.17 | x | 0.197 |
| CA0136155 | FM3912MP | END PLATE | -----    | 64 | EXT TH    | 230.0 | x | 152.5 | x | 5.0  | 9.06  | x | 6.0  | x | 0.197 |
| CA0136644 | FM3414MP | END PLATE | -----    | 32 | (64)EX TH | 230.0 | x | 152.5 | x | 10.8 | 9.06  | x | 6.0  | x | 0.397 |
| CA0138377 | FM3020MP | STEEL     | -----    | 8  | EXT LG    | 210.8 | x | 152.4 | x | 2.1  | 8.3   | x | 6.0  | x | 0.083 |
| CA0138378 | FM3667   | PAPER     | 2 PASS   | 44 | INT TH    | 196.9 | x | 138.0 | x | 2.8  | 7.75  | x | 5.43 | x | 0.11  |
| CA0138574 | FM2825   | BRONZE    | SUNBURST | 45 | INT TH    | 133.0 | x | 93.0  | x | 1.8  | 5.24  | x | 3.66 | x | 0.069 |
| CA0143874 | FM7337   | PAPER     | 2 PASS   | 36 | INT TH    | 223.0 | x | 71.0  | x | 4.9  | 8.78  | x | 2.8  | x | 0.191 |
| CK0245238 | FM2718MP | STEEL     | -----    | 4  | EXT LG    | 129.0 | x | 76.0  | x | 1.5  | 5.08  | x | 2.99 | x | 0.059 |
| CK0245239 | FM2719   | PAPER     | 2 PASS   | 33 | INT TH    | 117.9 | x | 68.1  | x | 2.2  | 4.64  | x | 2.68 | x | 0.087 |
| HU1127061 | FM4606MP | STEEL     | -----    | 3  | EXT LG    | 216.9 | x | 144.0 | x | 2.7  | 8.54  | x | 5.67 | x | 0.106 |
| HU1127612 | FM4625   | PAPER     | SUNBURST | 16 | INT TH    | 201.0 | x | 40.5  | x | 4.9  | 7.91  | x | 1.59 | x | 0.192 |
| HU7347402 | FM2344MP | STEEL     | -----    | 6  | EXT LG    | 220.0 | x | 145.5 | x | 2.7  | 8.66  | x | 5.73 | x | 0.105 |
| HU7347612 | FM4625   | PAPER     | SUNBURST | 16 | INT TH    | 201.0 | x | 40.5  | x | 4.9  | 7.91  | x | 1.59 | x | 0.192 |
| MI3148073 | FM4119   | GRAPHITE  | SUNBURST | 14 | INT TH    | 304.0 | x | 57.0  | x | 10.0 | 11.97 | x | 2.24 | x | 0.394 |

### FANTUZZI

|               |          |                      |          |     |        |       |   |       |   |     |       |   |       |   |       |
|---------------|----------|----------------------|----------|-----|--------|-------|---|-------|---|-----|-------|---|-------|---|-------|
| DO1.186046    | FM5192MP | STEEL                | -----    | 8   | EXT LG | 214.0 | x | 145.2 | x | 2.0 | 8.43  | x | 5.72  | x | 0.079 |
| DO2.126367    | FM4859   | OBSOLETE AFTER STOCK |          | 64  | INT TH | 355.5 | x | 200.0 | x | 7.3 | 14.0  | x | 7.87  | x | 0.285 |
| DO2.186045    | FM5189   | PAPER                | WAFFLE   | 45  | INT TH | 195.0 | x | 130.0 | x | 3.8 | 7.68  | x | 5.12  | x | 0.15  |
| AC4.125242    | FM7032MP | STEEL                | -----    | 4   | EXT LG | 300.0 | x | 127.0 | x | 4.6 | 11.81 | x | 5.0   | x | 0.181 |
| AC4.125368    | FM5459   | GRAPHITE             | SUNBURST | 25  | INT TH | 223.5 | x | 62.0  | x | 5.7 | 8.8   | x | 2.44  | x | 0.224 |
| AC4.126409    | FM4862MP | STEEL                | -----    | 6   | EXT SL | 450.0 | x | 235.0 | x | 7.1 | 17.72 | x | 9.25  | x | 0.278 |
| 10.AC4.286057 | FM4947   | PAPER                | 3 PASS   | 72  | INT TH | 467.0 | x | 281.0 | x | 5.5 | 18.38 | x | 11.06 | x | 0.217 |
| 10.AC4.286058 | FM4950MP | STEEL                | -----    | 120 | EXT TH | 483.0 | x | 300.0 | x | 5.0 | 19.02 | x | 11.81 | x | 0.197 |
| 1H7380700503  | FM2184MP | STEEL                | -----    | 3   | EXT SL | 201.7 | x | 129.5 | x | 2.7 | 7.94  | x | 5.1   | x | 0.106 |
| 1H7380761004  | FM2647   | PAPER                | 2 PASS   | 19  | INT TH | 178.0 | x | 34.0  | x | 4.8 | 7.01  | x | 1.34  | x | 0.189 |
| 1K507275223   | FM3006MP | STEEL                | -----    | 70  | EXT TH | 358.0 | x | 229.0 | x | 5.0 | 14.09 | x | 9.02  | x | 0.197 |
| 1K507275293   | FM4349   | PAPER                | WAFFLE   | 42  | INT TH | 340.0 | x | 206.0 | x | 5.5 | 13.39 | x | 8.11  | x | 0.217 |
| 1K507275303   | FM3010MP | STEEL                | -----    | 96  | EXT TH | 488.0 | x | 310.0 | x | 6.0 | 19.21 | x | 12.2  | x | 0.236 |



| REPLACES<br>OEM PT.NO. | FMC<br>PART NO. | MATERIAL | GROOVE<br>DETAILS | TEETH/<br>TANGS | SIZE MM    |       |   | SIZE INCH |   |     |       |   |       |   |       |
|------------------------|-----------------|----------|-------------------|-----------------|------------|-------|---|-----------|---|-----|-------|---|-------|---|-------|
| 1K507275343            | FM3007          | PAPER    | 3 PASS            | 60              | INT TH     | 466.0 | x | 284.0     | x | 5.6 | 18.35 | x | 11.18 | x | 0.22  |
| 1K507275773            | FM5578MP        | STEEL    | -----             | 96              | EXT TH     | 488.0 | x | 310.0     | x | 4.0 | 19.21 | x | 12.2  | x | 0.157 |
| 1K507275773b           | FM4404MP        | STEEL    | -----             | 96              | EXT TH     | 488.0 | x | 310.0     | x | 3.5 | 19.21 | x | 12.2  | x | 0.138 |
| 1K507275913            | FM5865          | PAPER    | WAFFLE            | 45              | INT TH     | 340.0 | x | 221.0     | x | 4.1 | 13.39 | x | 8.7   | x | 0.161 |
| 1K507275923            | FM6172MP        | STEEL    | -----             | 70              | EXT TH     | 358.0 | x | 239.0     | x | 5.0 | 14.09 | x | 9.41  | x | 0.197 |
| D210/507-275-303       | FM3010MP        | STEEL    | -----             | 96              | EXT TH     | 488.0 | x | 310.0     | x | 6.0 | 19.21 | x | 12.2  | x | 0.236 |
| D209/507-275-343       | FM3007          | PAPER    | 3 PASS            | 60              | INT TH     | 466.0 | x | 284.0     | x | 5.6 | 18.35 | x | 11.18 | x | 0.22  |
| 2730.76100             | FM2181          | BRONZE   | SUNBURST          | 19              | INT TH     | 177.8 | x | 34.3      | x | 4.8 | 7.0   | x | 1.35  | x | 0.189 |
| 2738.07000             | FM2184MP        | STEEL    | -----             | 3               | EXT SL     | 201.7 | x | 129.5     | x | 2.7 | 7.94  | x | 5.1   | x | 0.106 |
| FTZ00485               | FM4950MP        | STEEL    | -----             | 120             | EXT TH     | 483.0 | x | 300.0     | x | 5.0 | 19.02 | x | 11.81 | x | 0.197 |
| FTZ00486               | FM4947          | PAPER    | 3 PASS            | 72              | INT TH     | 467.0 | x | 281.0     | x | 5.5 | 18.38 | x | 11.06 | x | 0.217 |
| <b>FARESIN</b>         |                 |          |                   |                 |            |       |   |           |   |     |       |   |       |   |       |
| 610110601              | FM2971          | BRONZE   | WAFFLE            | 22              | INT TH     | 71.7  | x | 44.0      | x | 2.8 | 2.82  | x | 1.73  | x | 0.11  |
| 610114301              | FM3474MP        | STEEL    | -----             | 4               | EXT LG     | 85.0  | x | 49.2      | x | 1.5 | 3.35  | x | 1.94  | x | 0.059 |
| 610114401              | FM2969          | BRONZE   | WAFFLE            | 22              | INT TH     | 71.7  | x | 44.0      | x | 1.6 | 2.82  | x | 1.73  | x | 0.063 |
| <b>FARMTRAC</b>        |                 |          |                   |                 |            |       |   |           |   |     |       |   |       |   |       |
| D10085690              | FM2971          | BRONZE   | WAFFLE            | 22              | INT TH     | 71.7  | x | 44.0      | x | 2.8 | 2.82  | x | 1.73  | x | 0.11  |
| D10085700              | FM3474MP        | STEEL    | -----             | 4               | EXT LG     | 85.0  | x | 49.2      | x | 1.5 | 3.35  | x | 1.94  | x | 0.059 |
| D10085710              | FM2969          | BRONZE   | WAFFLE            | 22              | INT TH     | 71.7  | x | 44.0      | x | 1.6 | 2.82  | x | 1.73  | x | 0.063 |
| <b>FAY</b>             |                 |          |                   |                 |            |       |   |           |   |     |       |   |       |   |       |
| CKO245238              | FM2718MP        | STEEL    | -----             | 4               | EXT LG     | 129.0 | x | 76.0      | x | 1.5 | 5.08  | x | 2.99  | x | 0.059 |
| CKO245239              | FM2719          | PAPER    | 2 PASS            | 33              | INT TH     | 117.9 | x | 68.1      | x | 2.2 | 4.64  | x | 2.68  | x | 0.087 |
| <b>FENDT</b>           |                 |          |                   |                 |            |       |   |           |   |     |       |   |       |   |       |
| 138.105.220.250        | FM6014MP        | STEEL    | -----             | 28              | INT TH     | 140.0 | x | 80.3      | x | 2.0 | 5.51  | x | 3.16  | x | 0.079 |
| 178.100.220.510        | FM8584MP        | STEEL    | -----             | 44              | INT TH     | 168.0 | x | 105.2     | x | 2.5 | 6.61  | x | 4.14  | x | 0.098 |
| 178.100.220.540        | FM6011          | ORGANIC  | -----             | 6               | EXT LG     | 181.0 | x | 115.0     | x | 3.5 | 7.13  | x | 4.53  | x | 0.136 |
| 180.101.320.220        | FM9065          | BRONZE   | SPR/RAD           | 8               | EXT LG     | 171.5 | x | 124.4     | x | 2.0 | 6.75  | x | 4.9   | x | 0.079 |
| 205.100.200.500        | FM6473          | ORGANIC  | -----             | 8               | EXT LG     | 154.5 | x | 95.0      | x | 3.3 | 6.08  | x | 3.74  | x | 0.128 |
| 238.108.220.300        | FM8904MP        | STEEL    | -----             | 28              | INT TH     | 140.0 | x | 80.3      | x | 2.5 | 5.51  | x | 3.16  | x | 0.098 |
| 385.101.320.020        | FM9067          | BRONZE   | WAF/RAD           | 8               | EXT LG     | 171.5 | x | 124.4     | x | 2.9 | 6.75  | x | 4.9   | x | 0.114 |
| 514.100.100.140        | FM7692MP        | STEEL    | SINEWAVED         | 47              | (48)INT TH | 198.0 | x | 131.6     | x | 2.8 | 7.8   | x | 5.18  | x | 0.11  |
| 514.100.360.090        | FM8329          | BRONZE   | SUNBURST          | 30              | EXT TH     | 118.3 | x | 77.3      | x | 2.2 | 4.66  | x | 3.04  | x | 0.087 |
| 514.100.360.410        | FM8332MP        | STEEL    | -----             | 36              | INT TH     | 110.9 | x | 70.7      | x | 1.5 | 4.37  | x | 2.78  | x | 0.059 |
| 716.150.150.500        | FM8316MP        | STEEL    | -----             | 2               | EXT LG     | 254.0 | x | 150.0     | x | 4.0 | 10    | x | 5.9   | x | 0.157 |
| 716.150.220.660        | FM9076MP        | STEEL    | HARDENED          | 38              | INT TH     | 178.0 | x | 119.0     | x | 2.5 | 7.01  | x | 4.69  | x | 0.098 |
| 822.100.010.120        | FM9069          | BRONZE   | SUNBURST          | 41              | INT TH     | 177.7 | x | 119.4     | x | 2.5 | 7     | x | 4.7   | x | 0.098 |
| 822.100.101.130        | FM9072MP        | STEEL    | HARDENED          | 73              | EXT TH     | 187.7 | x | 140.0     | x | 2.0 | 7.39  | x | 5.51  | x | 0.079 |
| 822.100.150.040        | FM8527          | BRONZE   | SUN/WAG           | 36              | INT TH     | 223.5 | x | 71.3      | x | 4.8 | 8.8   | x | 2.81  | x | 0.189 |
| 822.100.200.950        | FM8584MP        | STEEL    | -----             | 44              | INT TH     | 168.0 | x | 105.2     | x | 2.5 | 6.61  | x | 4.14  | x | 0.098 |
| 824.100.100.130        | FM7688MP        | STEEL    | SINEWAVED         | 40              | (41)INT TH | 233.0 | x | 160.2     | x | 2.8 | 9.17  | x | 6.31  | x | 0.11  |
| 824.100.320.070        | FM3602MP        | STEEL    | -----             | 35              | INT TH     | 170.9 | x | 102.9     | x | 2.0 | 6.73  | x | 4.05  | x | 0.079 |
| 824.100.360.170        | FM2277          | BRONZE   | SUNBURST          | 27              | EXT TH     | 137.4 | x | 90.9      | x | 2.0 | 5.41  | x | 3.58  | x | 0.079 |
| 824.100.360.180        | FM3594MP        | STEEL    | -----             | 29              | INT TH     | 131.1 | x | 85.1      | x | 2.0 | 5.16  | x | 3.35  | x | 0.079 |

| REPLACES OEM PT.NO.                                   | FMC PART NO. | MATERIAL  | GROOVE DETAILS | TEETH/TANGS | SIZE MM   | SIZE INCH                                 |
|---|--------------|-----------|----------------|-------------|-----------|---|
| 824.100.360.190                                       | FM3592MP     | STEEL     | -----          | 29          | INT TH    | 131.1 x 85.1 x 1.5 5.16 x 3.35 x 0.059    |
| 824.100.360.200                                       | FM3596MP     | STEEL     | -----          | 29          | INT TH    | 131.1 x 85.1 x 2.5 5.16 x 3.35 x 0.098    |
| 835.100.321.071                                       | FM8527       | BRONZE    | SUN/WAG        | 36          | INT TH    | 223.5 x 71.3 x 4.8 8.8 x 2.81 x 0.189     |
| 924.152.220.480                                       | FM9073       | BRONZE    | SUN/WAG        | 73          | EXT TH    | 188.4 x 134.6 x 2.8 7.42 x 5.3 x 0.11     |
| G001990200330   | FM8778MP     | STEEL     | -----          | 2           | EXT LG    | 195.0 x 110.0 x 4.0 7.68 x 4.33 x 0.157   |
| G001990200370   | FM7685       | PAPER     | WAFFLE         | 12          | EXT LG    | 252.7 x 180.6 x 2.5 9.95 x 7.11 x 0.098   |
| G001990200590   | FM2277       | BRONZE    | SUNBURST       | 27          | EXT TH    | 137.4 x 90.9 x 2.0 5.41 x 3.58 x 0.079    |
| G001990200600   | FM3592MP     | STEEL     | -----          | 29          | INT TH    | 131.1 x 85.1 x 1.5 5.16 x 3.35 x 0.059    |
| <b>FENWICK</b>  |              |           |                |             |           |   |
| 3501718   | FM2032MP     | STEEL     | -----          | 36          | (42)IN TH | 176.3 x 102.6 x 2.0 6.94 x 4.04 x 0.079   |
| 8100670   | FM4459       | OBSOLETE  | SPR/RAD        | 60          | (63)IN TH | 207.0 x 157.0 x 2.7 8.15 x 6.18 x 0.106   |
| <b>FERMEC (TEREX)</b>                                 |              |           |                |             |           |   |
| 3384487M1   | FM8189       | BRONZE    | WAFFLE         | 6           | EXT LG    | 156.8 x 110.2 x 2.5 6.17 x 4.34 x 0.098   |
| 3523622M1   | FM2781       | GRAPHITE  | SUNBURST       | 15          | INT TH    | 213.0 x 44.0 x 10.0 8.38 x 1.73 x 0.394   |
| 6190039M1   | FM3701       | PAPER     | 2 PASS         | 43          | (45)IN TH | 133.1 x 92.7 x 2.1 5.24 x 3.65 x 0.084    |
| 6190042M1   | FM1324MP     | STEEL     | -----          | 54          | EXT TH    | 139.2 x 98.6 x 1.8 5.48 x 3.88 x 0.07     |
| 6190105M1   | FM3264MP     | STEEL     | -----          | 26          | EXT TH    | 143.5 x 89.5 x 2.2 5.65 x 3.52 x 0.084    |
| 6190106M1   | FM3261       | PAPER     | 2 PASS         | 40          | INT TH    | 127.1 x 82.2 x 2.5 5.0 x 3.24 x 0.098     |
| 6190295M1   | FM3095       | GRAPHITE  | SUNBURST       | 13          | INT TH    | 215.0 x 36.5 x 10.0 8.46 x 1.44 x 0.394   |
| 6193395M1   | FM7337       | PAPER     | 2 PASS         | 36          | INT TH    | 223.0 x 71.0 x 4.9 8.78 x 2.8 x 0.191     |
| 6193396M1   | FM3414MP     | END PLATE | -----          | 32          | (64)EX TH | 230.0 x 152.5 x 10.8 9.06 x 6.0 x 0.397   |
| 6193397M1   | FM3912MP     | END PLATE | -----          | 64          | EXT TH    | 230.0 x 152.5 x 5.0 9.06 x 6.0 x 0.197    |
| 6193399M1   | FM3910MP     | END PLATE | -----          | 64          | EXT TH    | 230.0 x 151.0 x 9.0 9.06 x 5.94 x 0.354   |
| 6193509M1   | FM4993       | PAPER     | 2 PASS         | 54          | EXT TH    | 139.0 x 99.0 x 2.7 5.47 x 3.9 x 0.104     |
| 6194352M1   | FM2828MP     | STEEL     | -----          | 6           | EXT LG    | 151.0 x 98.0 x 2.5 5.94 x 3.86 x 0.098    |
| 6194353M1   | FM2825       | BRONZE    | SUNBURST       | 45          | INT TH    | 133.0 x 93.0 x 1.8 5.24 x 3.66 x 0.069    |
| 6195568M1   | FM6587       | PAPER     | WAFFLE         | 15          | INT TH    | 289.0 x 43.0 x 6.7 11.38 x 1.69 x 0.262   |
| <b>FIAT ALLIS &amp; FIAT HITACHI (ALLIS CHALMERS)</b> |              |           |                |             |           |   |
| 000 14687   | FM2840MP     | STEEL     | -----          | 67          | INT TH    | 290.1 x 195.1 x 2.5 11.42 x 7.68 x 0.098  |
| 000 18752   | FM1644MP     | STEEL     | -----          | 88          | INT TH    | 365.8 x 273.1 x 2.3 14.4 x 10.75 x 0.09   |
| 000 22767   | FM5049       | BRONZE    | SUNBURST       | 134         | EXT TH    | 429.8 x 320.7 x 3.9 16.92 x 12.63 x 0.155 |
| 000 22768   | FM5132MP     | STEEL     | -----          | 97          | INT TH    | 408.9 x 302.0 x 2.3 16.1 x 11.89 x 0.091  |
| 000 22770   | FM1882MP     | STEEL     | -----          | 63          | INT TH    | 289.1 x 193.8 x 2.3 11.38 x 7.63 x 0.09   |
| 000 25637   | FM1607       | BRONZE    | -----          | 119         | EXT TH    | 254.0 x 171.5 x 4.7 10.0 x 6.75 x 0.187   |
| 000 26391   | FM1603       | BRONZE    | -----          | 120         | EXT TH    | 384.8 x 292.6 x 4.7 15.15 x 11.52 x 0.187 |
| 000 48461   | FM1635       | BRONZE    | SPR/RAD        | 64          | INT TH    | 356.0 x 198.0 x 7.1 14.02 x 7.8 x 0.28    |
| 005 08052   | FM1801       | BRONZE    | WAFFLE         | 76          | EXT TH    | 164.1 x 103.1 x 2.8 6.46 x 4.06 x 0.11    |
| 005 08053   | FM1220MP     | STEEL     | -----          | 40          | INT TH    | 152.4 x 82.3 x 1.6 6.0 x 3.24 x 0.063     |
| 005 16809   | FM1355       | OBSOLETE  | -----          | 67          | EXT TH    | 347.5 x 256.5 x 4.0 13.68 x 10.1 x 0.156  |
| 005 16810   | FM4826MP     | STEEL     | -----          | 48          | INT TH    | 325.1 x 236.5 x 2.4 12.8 x 7.31 x 0.094   |
| 005 39747   | FM6672MP     | STEEL     | -----          | 65          | INT TH    | 259.8 x 190.0 x 2.5 10.23 x 7.48 x 0.098  |
| 005 55489   | FM4197       | BRONZE    | SPR/WAG        | 50          | INT TH    | 305.0 x 156.0 x 7.1 12.01 x 6.14 x 0.28   |
| 005 63495   | FM1601       | BRONZE    | -----          | 95          | EXT TH    | 305.6 x 212.6 x 4.7 12.03 x 8.37 x 0.187  |

| REPLACES<br>OEM PT.NO. | FMC<br>PART NO. | MATERIAL  | GROOVE<br>DETAILS | TEETH/<br>TANGS | SIZE MM |       |   | SIZE INCH |   |     |       |   |       |   |       |
|------------------------|-----------------|-----------|-------------------|-----------------|---------|-------|---|-----------|---|-----|-------|---|-------|---|-------|
| 005 66519              | FM5862MP        | STEEL     | HARD/BLACK        | 21              | INT TH  | 229.0 | x | 171.0     | x | 2.0 | 9.02  | x | 6.73  | x | 0.079 |
| 005 66520              | FM5055          | BRONZE    | -----             | 28              | EXT TH  | 239.0 | x | 180.1     | x | 4.0 | 9.41  | x | 7.09  | x | 0.157 |
| 005 67385              | FM2840MP        | STEEL     | -----             | 67              | INT TH  | 290.1 | x | 195.1     | x | 2.5 | 11.42 | x | 7.68  | x | 0.098 |
| 005 67386              | FM1601          | BRONZE    | -----             | 95              | EXT TH  | 305.6 | x | 212.6     | x | 4.7 | 12.03 | x | 8.37  | x | 0.187 |
| 005 75812              | FM1635          | BRONZE    | SPR/RAD           | 64              | INT TH  | 356.0 | x | 198.0     | x | 7.1 | 14.02 | x | 7.8   | x | 0.28  |
| 005 81003              | FM3236MP        | STEEL     | -----             | 45              | INT TH  | 195.1 | x | 120.9     | x | 2.5 | 7.68  | x | 4.76  | x | 0.098 |
| 005 82301              | FM3017          | BRONZE    | SUNBURST          | 68              | EXT TH  | 208.0 | x | 145.0     | x | 3.5 | 8.19  | x | 5.71  | x | 0.138 |
| 005 85349              | OBSOLETE        | BRONZE    | -----             | 50              | INT TH  | 305.0 | x | 156.0     | x | 7.1 | 12.01 | x | 6.14  | x | 0.28  |
| 005 86578              | FM1617          | BRONZE    | SPR/WAG           | 95              | EXT TH  | 304.8 | x | 212.9     | x | 4.3 | 12    | x | 8.38  | x | 0.168 |
| 005 86599              | FM1635          | BRONZE    | SPR/RAD           | 64              | INT TH  | 355.6 | x | 198.1     | x | 7.1 | 14    | x | 7.8   | x | 0.28  |
| 005 87050              | FM1601          | BRONZE    | -----             | 95              | EXT TH  | 305.6 | x | 212.6     | x | 4.7 | 12.03 | x | 8.37  | x | 0.187 |
| 005 87661              | FM4197          | BRONZE    | SPR/WAG           | 50              | INT TH  | 305.1 | x | 156.0     | x | 7.1 | 12.01 | x | 6.14  | x | 0.28  |
| 005 88222              | FM7108MP        | STEEL     | -----             | 51              | INT TH  | 225.0 | x | 137.9     | x | 3.0 | 8.86  | x | 5.43  | x | 0.118 |
| 005 88223              | FM7105          | BRONZE    | SUNBURST          | 55              | EXT TH  | 239.0 | x | 163.1     | x | 4.3 | 9.41  | x | 6.42  | x | 0.169 |
| 005 89025              | FM6678MP        | STEEL     | -----             | 90              | INT TH  | 352.0 | x | 266.0     | x | 3.5 | 13.86 | x | 10.47 | x | 0.138 |
| 005 89026              | FM3913          | BRONZE    | SPR/RAD           | 122             | EXT TH  | 370.0 | x | 280.0     | x | 4.8 | 14.57 | x | 11.02 | x | 0.189 |
| 005 91030              | FM1619          | BRONZE    | SPR/WAG           | 94              | INT TH  | 444.5 | x | 295.5     | x | 7.1 | 17.5  | x | 11.63 | x | 0.28  |
| 005 97258              | FM1617          | BRONZE    | SPR/WAG           | 95              | EXT TH  | 304.8 | x | 212.9     | x | 4.3 | 12.0  | x | 8.38  | x | 0.168 |
| 005 98114              | FM7804MP        | STEEL     | -----             | 51              | INT TH  | 225.0 | x | 138.0     | x | 8.0 | 8.86  | x | 5.43  | x | 0.315 |
| 005 98116              | FM7804MP        | STEEL     | -----             | 51              | INT TH  | 225.0 | x | 138.0     | x | 8.0 | 8.86  | x | 5.43  | x | 0.315 |
| 005 99151              | OBSOLETE        | STEEL     | -----             | 45              | INT TH  | 195.0 | x | 121.0     | x | 6.0 | 7.68  | x | 4.76  | x | 0.236 |
| 006 10206              | FM1635          | BRONZE    | SPR/RAD           | 64              | INT TH  | 356.0 | x | 198.0     | x | 7.1 | 14.02 | x | 7.8   | x | 0.28  |
| 020 39351              | FM7462MP        | END PLATE | -----             | 60              | EXT TH  | 154.3 | x | 113.5     | x | 8.0 | 6.07  | x | 4.47  | x | 0.315 |
| 020 39353              | FM1216MP        | STEEL     | -----             | 60              | EXT TH  | 154.2 | x | 113.8     | x | 1.8 | 6.07  | x | 4.48  | x | 0.07  |
| 047 55381              | FM4442FP        | STEEL     | REINF PLATE       | 6               | HOLE    | 186.5 | x | 132.0     | x | 2.1 | 7.34  | x | 5.2   | x | 0.83  |
| 047 61032              | FM3382FP        | STEEL     | FLEXI PLATE       | 6               | HOLE    | 339.7 | x | 133.4     | x | 1.5 | 13.37 | x | 5.25  | x | 0.059 |
| 048 19283              | FM3382FP        | STEEL     | FLEXI PLATE       | 6               | HOLE    | 339.7 | x | 133.4     | x | 1.5 | 13.37 | x | 5.25  | x | 0.059 |
| 049 07850              | FM1900MP        | STEEL     | -----             | 64              | EXT TH  | 205.5 | x | 145.3     | x | 1.7 | 8.09  | x | 5.72  | x | 0.067 |
| 049 13971              | FM3650MP        | STEEL     | -----             | 54              | EXT TH  | 139.2 | x | 98.6      | x | 3.0 | 5.48  | x | 3.88  | x | 0.118 |
| 049 13985              | FM2829          | PAPER     | 2 PASS            | 45              | INT TH  | 133.1 | x | 92.7      | x | 2.1 | 5.24  | x | 3.65  | x | 0.083 |
| 049 17871              | FM4646MP        | STEEL     | -----             | 12              | EXT TH  | 156.0 | x | 119.2     | x | 1.2 | 6.14  | x | 4.69  | x | 0.045 |
| 049 17873              | FM4643          | BRONZE    | SPR/RAD           | 24              | INT TH  | 143.0 | x | 109.8     | x | 1.6 | 5.63  | x | 4.32  | x | 0.061 |
| 049 17896              | FM4647          | BRONZE    | SPR/RAD           | 34              | INT TH  | 100.0 | x | 68.2      | x | 1.6 | 3.94  | x | 2.69  | x | 0.061 |
| 049 17897              | FM4650MP        | STEEL     | -----             | 24              | EXT TH  | 108.2 | x | 76.2      | x | 1.2 | 4.26  | x | 3.0   | x | 0.045 |
| 049 40457              | FM2063          | PAPER     | WAFFLE            | 41              | INT TH  | 125.0 | x | 68.6      | x | 2.9 | 4.92  | x | 2.7   | x | 0.114 |
| 049 40458              | FM2440MP        | STEEL     | -----             | 4               | EXT LG  | 137.8 | x | 80.0      | x | 3.2 | 5.42  | x | 3.15  | x | 0.125 |
| 049 41481              | FM2070MP        | STEEL     | -----             | 8               | EXT LG  | 131.6 | x | 77.2      | x | 1.0 | 5.18  | x | 3.04  | x | 0.039 |
| 049 41581              | FM2449          | BRONZE    | SUNBURST          | 41              | INT TH  | 125.0 | x | 68.5      | x | 3.0 | 4.92  | x | 2.7   | x | 0.118 |
| 049 55520              | FM1635          | BRONZE    | SPR/RAD           | 64              | INT TH  | 356.0 | x | 198.0     | x | 7.1 | 14.02 | x | 7.8   | x | 0.28  |
| 049 57429              | FM3913          | BRONZE    | SPR/RAD           | 122             | EXT TH  | 370.0 | x | 280.0     | x | 4.8 | 14.57 | x | 11.02 | x | 0.189 |
| 049 58069              | FM3913          | BRONZE    | SPR/RAD           | 122             | EXT TH  | 370.0 | x | 280.0     | x | 4.8 | 14.57 | x | 11.02 | x | 0.189 |
| 049 58653              | FM1635          | BRONZE    | SPR/RAD           | 64              | INT TH  | 356.0 | x | 198.0     | x | 7.1 | 14.02 | x | 7.8   | x | 0.28  |
| 049 59321              | FM4197          | BRONZE    | SPR/WAG           | 50              | INT TH  | 305.0 | x | 156.0     | x | 7.1 | 12.01 | x | 6.14  | x | 0.28  |
| 049 59448              | FM3913          | BRONZE    | SPR/RAD           | 122             | EXT TH  | 370.0 | x | 280.0     | x | 4.8 | 14.57 | x | 11.02 | x | 0.189 |
| 049 67080              | FM5305          | BRONZE    | SUNBURST          | 74              | EXT TH  | 188.0 | x | 138.0     | x | 3.2 | 7.4   | x | 5.43  | x | 0.126 |
| 049 67564              | OBSOLETE        | STEEL     | -----             | 45              | INT TH  | 180.0 | x | 115.0     | x | 2.0 | 7.09  | x | 4.53  | x | 0.079 |
| 049 68909              | OBSOLETE        | STEEL     | -----             | 45              | INT TH  | 180.0 | x | 115.0     | x | 6.0 | 7.09  | x | 4.53  | x | 0.236 |
| 049 79644              | OBSOLETE        | STEEL     | -----             | 90              | INT TH  | 352.0 | x | 266.0     | x | 3.0 | 13.86 | x | 10.47 | x | 0.118 |

| REPLACES<br>OEM PT.NO. | FMC<br>PART NO. | MATERIAL | GROOVE<br>DETAILS | TEETH/<br>TANGS | SIZE MM | SIZE INCH           |                       |
|------------------------|-----------------|----------|-------------------|-----------------|---------|---------------------|-----------------------|
| 049 84755              | FM3017          | BRONZE   | SUNBURST          | 68              | EXT TH  | 208.0 x 145.0 x 3.5 | 8.19 x 5.71 x 0.138   |
| 049 90970              | FM7817          | PAPER    | 2 PASS            | 45              | INT TH  | 175.8 x 115.4 x 2.4 | 6.92 x 4.54 x 0.094   |
| 049 90971              | FM7820MP        | STEEL    | -----             | 8               | EXT LG  | 191.7 x 127.3 x 2.0 | 7.55 x 5.01 x 0.079   |
| 069 00790              | FM1337OE        | BRONZE   | RADIAL            | 45              | INT TH  | 133.1 x 92.7 x 2.3  | 5.24 x 3.65 x 0.09    |
| 075 19924              | FM1619          | BRONZE   | SPR/WAG           | 94              | INT TH  | 444.5 x 295.5 x 7.1 | 17.5 x 11.63 x 0.28   |
| 087 61313              | FM3358MP        | STEEL    | -----             | 6               | EXT LG  | 143.5 x 88.5 x 2.0  | 5.65 x 3.48 x 0.079   |
| 087 61315              | FM3561          | PAPER    | WAFFLE            | 30              | INT TH  | 131.0 x 79.2 x 2.6  | 5.16 x 3.12 x 0.102   |
| 092 76227              | FM6068MP        | STEEL    | -----             | 57              | EXT TH  | 162.6 x 123.0 x 1.8 | 6.4 x 4.84 x 0.071    |
| 092 76228              | FM6065          | BRONZE   | SPR/RAD           | 42              | INT TH  | 153.9 x 114.8 x 2.5 | 6.06 x 4.52 x 0.098   |
| 094 33405              | FM3565          | BRONZE   | RADIAL            | 68              | EXT TH  | 112.3 x 71.3 x 2.1  | 4.42 x 2.81 x 0.083   |
| 094 35217              | FM4074MP        | STEEL    | -----             | 42              | INT TH  | 101.6 x 64.8 x 1.6  | 4.0 x 2.55 x 0.063    |
| 094 49009              | FM3346MP        | STEEL    | -----             | 54              | EXT TH  | 139.2 x 98.6 x 2.5  | 5.48 x 3.88 x 0.1     |
| 095 02757              | FM1216MP        | STEEL    | -----             | 60              | EXT TH  | 154.2 x 113.8 x 1.8 | 6.07 x 4.48 x 0.07    |
| 098 46631              | FM5911          | GRAPHITE | SUN/RAD           | 16              | INT TH  | 204.0 x 40.0 x 4.9  | 8.03 x 1.57 x 0.193   |
| 098 46632              | FM5914MP        | STEEL    | -----             | 2               | EXT LG  | 209.0 x 140.0 x 2.7 | 8.23 x 5.51 x 0.106   |
| 099 26134              | FM6622MP        | STEEL    | -----             | 12              | EXT SL  | 339.4 x 244.1 x 2.6 | 13.36 x 9.61 x 0.102  |
| 099 26135              | FM4517          | BRONZE   | RAD/2 PASS        | 58              | INT TH  | 317.0 x 232.0 x 4.0 | 12.48 x 9.13 x 0.157  |
| 099 26856              | FM4519          | OBSOLETE | RAD/2 PASS        | 58              | INT TH  | 317.0 x 232.0 x 5.0 | 12.48 x 9.13 x 0.197  |
| 099 68289              | FM3264MP        | STEEL    | -----             | 26              | EXT TH  | 143.5 x 89.5 x 2.2  | 5.65 x 3.52 x 0.084   |
| 099 68290              | FM3261          | PAPER    | 2 PASS            | 40              | INT TH  | 127.1 x 82.2 x 2.5  | 5.0 x 3.24 x 0.98     |
| 700 25637              | FM1607          | BRONZE   | -----             | 119             | EXT TH  | 254.0 x 171.5 x 4.7 | 10.0 x 6.75 x 0.187   |
| 700 25638              | FM3072MP        | STEEL    | -----             | 77              | INT TH  | 241.3 x 158.8 x 1.6 | 9.5 x 6.25 x 0.063    |
| 700 41781              | FM4826MP        | STEEL    | -----             | 48              | INT TH  | 325.1 x 236.5 x 2.4 | 12.8 x 7.31 x 0.094   |
| 700 44478              | FM1355          | BRONZE   | -----             | 67              | EXT TH  | 347.5 x 256.5 x 4.0 | 13.68 x 10.1 x 0.156  |
| 700 51952              | FM5132MP        | STEEL    | -----             | 97              | INT TH  | 408.9 x 302.0 x 2.3 | 16.1 x 11.89 x 0.091  |
| 700 57375              | FM1355          | BRONZE   | -----             | 67              | EXT TH  | 347.5 x 256.5 x 4.0 | 13.68 x 10.1 x 0.156  |
| 700 94681              | FM1380MP        | STEEL    | -----             | 120             | INT TH  | 490.5 x 373.9 x 2.3 | 19.31 x 14.72 x 0.09  |
| 700 94868              | FM4905          | BRONZE   | SPR/WAG           | 160             | EXT TH  | 512.8 x 394.5 x 4.0 | 20.19 x 15.53 x 0.157 |
| 701 78360              | FM1355          | BRONZE   | -----             | 67              | EXT TH  | 347.5 x 256.5 x 4.0 | 13.68 x 10.1 x 0.156  |
| 706 23017              | FM5049          | BRONZE   | SUNBURST          | 134             | EXT TH  | 429.8 x 320.7 x 3.9 | 16.92 x 12.63 x 0.155 |
| 706 23018              | FM5132MP        | STEEL    | -----             | 97              | INT TH  | 408.9 x 302.0 x 2.3 | 16.1 x 11.89 x 0.091  |
| 706 23463              | FM3011          | PAPER    | 2 PASS            | 53              | INT TH  | 342.9 x 220.5 x 5.2 | 13.5 x 8.68 x 0.204   |
| 706 23464              | FM3014MP        | STEEL    | -----             | 83              | EXT TH  | 355.0 x 238.4 x 6.3 | 13.98 x 9.38 x 0.247  |
| 706 24244              | FM2379          | BRONZE   | SUNBRST           | 29              | INT TH  | 168.1 x 119.1 x 2.5 | 6.62 x 4.69 x 0.1     |
| 706 24245              | FM2382MP        | STEEL    | -----             | 8               | EXT LG  | 180.1 x 129.5 x 2.1 | 7.09 x 5.1 x 0.083    |
| 706 24562              | FM4826MP        | STEEL    | -----             | 48              | INT TH  | 325.1 x 236.5 x 2.4 | 12.8 x 7.31 x 0.094   |
| 706 29863              | FM1687          | BRONZE   | SUNBURST          | 34              | INT TH  | 198.1 x 140.5 x 2.5 | 7.8 x 5.53 x 0.098    |
| 706 29864              | FM3020MP        | STEEL    | -----             | 8               | EXT LG  | 210.8 x 152.4 x 2.1 | 8.3 x 6.0 x 0.083     |
| 706 42061              | FM2705B         | BRONZE   | SUNBURST          | 93              | EXT TH  | 239.8 x 171.6 x 3.5 | 9.44 x 6.76 x 0.138   |
| 706 42113              | FM2395B         | BRONZE   | SUNBURST          | 100             | EXT TH  | 214.6 x 151.6 x 3.1 | 8.45 x 5.97 x 0.122   |
| 706 42146              | FM2398MP        | STEEL    | DISHED            | 56              | INT TH  | 203.2 x 138.4 x 2.3 | 8.0 x 5.45 x 0.091    |
| 706 42147              | FM2704MP        | STEEL    | -----             | 64              | INT TH  | 228.6 x 158.7 x 2.6 | 9.0 x 6.25 x 0.102    |
| 706 42453              | FM3014MP        | STEEL    | -----             | 83              | EXT TH  | 355.0 x 238.4 x 6.3 | 13.98 x 9.37 x 0.248  |
| 706 45451              | FM3011          | PAPER    | 2 PASS            | 53              | INT TH  | 342.9 x 220.5 x 5.2 | 13.5 x 8.68 x 0.204   |
| 706 57968              | FM2398MP        | STEEL    | DISHED            | 56              | INT TH  | 203.2 x 138.7 x 2.3 | 8.0 x 5.46 x 0.091    |
| 706 74036              | FM1262MP        | STEEL    | -----             | 8               | EXT LG  | 142.5 x 99.1 x 1.6  | 5.61 x 3.9 x 0.063    |
| 706 75510              | FM1687          | BRONZE   | SUNBURST          | 34              | INT TH  | 198.1 x 140.5 x 2.5 | 7.8 x 5.53 x 0.098    |

| REPLACES<br>OEM PT.NO. | FMC<br>PART NO. | MATERIAL  | GROOVE<br>DETAILS | TEETH/<br>TANGS | SIZE MM    |       |   | SIZE INCH |   |     |       |   |       |   |       |
|------------------------|-----------------|-----------|-------------------|-----------------|------------|-------|---|-----------|---|-----|-------|---|-------|---|-------|
| 706 79935              | FM2705B         | BRONZE    | SUNBURST          | 93              | EXT TH     | 239.8 | x | 171.6     | x | 3.5 | 9.44  | x | 6.76  | x | 0.138 |
| 706 88736              | FM2710MP        | STEEL     | -----             | 52              | INT TH     | 177.8 | x | 128.2     | x | 2.3 | 7.0   | x | 5.05  | x | 0.091 |
| 706 88802              | FM2704MP        | STEEL     | -----             | 64              | INT TH     | 228.6 | x | 158.7     | x | 2.6 | 9.0   | x | 6.25  | x | 0.102 |
| 706 93536              | FM2379          | BRONZE    | SUNBURST          | 29              | INT TH     | 168.1 | x | 119.1     | x | 2.5 | 6.62  | x | 4.69  | x | 0.1   |
| 707 34526              | FM1307OE        | BRONZE    | RADIAL            | 52              | INT TH     | 148.6 | x | 107.7     | x | 2.6 | 5.85  | x | 4.24  | x | 0.102 |
| 710 04870              | FM1216MP        | STEEL     | -----             | 60              | EXT TH     | 154.2 | x | 113.8     | x | 1.8 | 6.07  | x | 4.48  | x | 0.07  |
| 710 04876              | FM1307OE        | BRONZE    | RADIAL            | 52              | INT TH     | 148.6 | x | 107.7     | x | 2.6 | 5.85  | x | 4.24  | x | 0.102 |
| 710 05843              | FM1307OE        | BRONZE    | RADIAL            | 52              | INT TH     | 148.6 | x | 107.7     | x | 2.6 | 5.85  | x | 4.24  | x | 0.102 |
| 714 48878              | FM4686MP        | STEEL     | -----             | 81              | EXT TH     | 243.6 | x | 152.1     | x | 2.5 | 9.59  | x | 5.99  | x | 0.098 |
| 714 48879              | FM6120-3.0      | STEEL     | -----             | 81              | EXT TH     | 243.5 | x | 153.0     | x | 3.0 | 9.59  | x | 6.02  | x | 0.118 |
| 714 48880              | FM6896MP        | STEEL     | -----             | 81              | EXT TH     | 243.6 | x | 152.1     | x | 2.0 | 9.59  | x | 5.99  | x | 0.079 |
| 714 48881              | FM4089          | PAPER     | 3 PASS            | 48              | INT TH     | 232.7 | x | 142.0     | x | 4.0 | 9.16  | x | 5.59  | x | 0.157 |
| 714 48936              | FM4650MP        | STEEL     | -----             | 24              | EXT TH     | 108.2 | x | 76.2      | x | 1.2 | 4.26  | x | 3.0   | x | 0.045 |
| 714 48940              | FM4647          | BRONZE    | SPR/RAD           | 34              | INT TH     | 100.0 | x | 68.2      | x | 1.6 | 3.94  | x | 2.69  | x | 0.061 |
| 714 48948              | FM7038MP        | STEEL     | HARD/BLACK        | 64              | EXT TH     | 196.4 | x | 140.0     | x | 2.9 | 7.73  | x | 5.51  | x | 0.114 |
| 714 48951              | FM7038-3.5      | STEEL     | HARD/BLACK        | 64              | EXT TH     | 196.4 | x | 140.0     | x | 3.5 | 7.73  | x | 5.51  | x | 0.138 |
| 714 48985              | FM4933          | BRONZE    | WAF/WAG           | 45              | INT TH     | 187.0 | x | 132.6     | x | 3.0 | 7.36  | x | 5.22  | x | 0.118 |
| 714 67158              | FM3231          | PAPER     | WAFFLE            | 38              | (45)INT TH | 166.0 | x | 136.0     | x | 1.8 | 6.54  | x | 5.35  | x | 0.07  |
| 714 67159              | FM3234MP        | STEEL     | -----             | 12              | EXT LG     | 175.0 | x | 146.0     | x | 1.4 | 6.89  | x | 5.75  | x | 0.053 |
| 730 21191              | FM2858MP        | STEEL     | -----             | 6               | EXT TH     | 274.3 | x | 201.9     | x | 2.7 | 10.8  | x | 7.95  | x | 0.107 |
| 730 21215              | FM1965          | BRONZE    | SPR/WAG           | 60              | INT TH     | 253.7 | x | 187.5     | x | 3.9 | 9.99  | x | 7.38  | x | 0.153 |
| 730 44593              | FM1965          | BRONZE    | SPR/WAG           | 60              | INT TH     | 253.7 | x | 187.5     | x | 3.9 | 9.99  | x | 7.38  | x | 0.153 |
| 730 46030              | FM2467          | BRONZE    | SPR/RAD           |                 |            | 253.5 | x | 74.4      | x | 3.9 | 9.98  | x | 2.93  | x | 0.153 |
| 730 47702              | FM3568MP        | STEEL     | -----             | 8               | EXT LG     | 330.1 | x | 255.8     | x | 3.1 | 13.0  | x | 10.08 | x | 0.122 |
| 730 47703              | FM1417          | CARBON PA | SUNBURST          | 57              | INT TH     | 303.8 | x | 235.2     | x | 3.9 | 11.96 | x | 9.26  | x | 0.153 |
| 730 58782              | FM2858MP        | STEEL     | -----             | 6               | EXT TH     | 274.3 | x | 201.9     | x | 2.7 | 10.8  | x | 7.95  | x | 0.107 |
| 730 58783              | FM1179          | GRAPHITE  | SUNBURST          | 60              | INT TH     | 253.7 | x | 187.5     | x | 3.9 | 9.99  | x | 7.38  | x | 0.153 |
| 730 62078              | FM2692MP        | STEEL     | -----             | 8               | EXT LG     | 330.1 | x | 255.8     | x | 3.1 | 13.0  | x | 10.08 | x | 0.122 |
| 730 76679              | FM1179          | GRAPHITE  | SUNBURST          | 60              | INT TH     | 253.7 | x | 187.5     | x | 3.9 | 9.99  | x | 7.38  | x | 0.153 |
| 730 77153              | FM1417          | CARBON PA | SUNBURST          | 57              | INT TH     | 303.8 | x | 235.2     | x | 3.9 | 11.96 | x | 9.26  | x | 0.153 |
| 731 18088              | FM1337OE        | BRONZE    | RADIAL            | 45              | INT TH     | 133.1 | x | 92.7      | x | 2.3 | 5.24  | x | 3.65  | x | 0.09  |
| 731 18089              | FM1324MP        | STEEL     | -----             | 54              | EXT TH     | 139.2 | x | 98.6      | x | 1.8 | 5.48  | x | 3.88  | x | 0.07  |
| 731 18133              | FM1337OE        | BRONZE    | RADIAL            | 45              | INT TH     | 133.1 | x | 92.7      | x | 2.3 | 5.24  | x | 3.65  | x | 0.09  |
| 731 28188              | FM2705B         | BRONZE    | SUNBURST          | 93              | EXT TH     | 239.8 | x | 171.6     | x | 3.5 | 9.44  | x | 6.76  | x | 0.138 |
| 731 28407              | FM2395B         | BRONZE    | SUNBURST          | 100             | EXT TH     | 214.6 | x | 151.6     | x | 3.1 | 8.45  | x | 5.97  | x | 0.122 |
| 731 29164              | FM1381OE        | BRONZE    | RADIAL            | 52              | INT TH     | 148.6 | x | 107.7     | x | 2.9 | 5.85  | x | 4.24  | x | 0.114 |
| 731 38264              | FM2467          | BRONZE    | SPR/RAD           |                 |            | 253.5 | x | 74.4      | x | 3.9 | 9.98  | x | 2.93  | x | 0.153 |
| 731 40703              | FM3021          | BRONZE    | SUNBURST          | 87              | INT TH     | 306.0 | x | 258.0     | x | 3.0 | 12.05 | x | 10.16 | x | 0.118 |
| 731 40704              | FM3024MP        | STEEL     | -----             | 12              | EXT LG     | 317.7 | x | 268.0     | x | 3.0 | 12.51 | x | 10.55 | x | 0.118 |
| 731 40719              | FM3586MP        | STEEL     | -----             | 12              | EXT LG     | 320.0 | x | 268.0     | x | 2.5 | 12.6  | x | 10.55 | x | 0.098 |
| 731 42391              | FM3589          | OBSOLETE  | SUNBURST          | 87              | INT TH     | 306.0 | x | 258.0     | x | 3.4 | 12.05 | x | 10.16 | x | 0.134 |
| 731 42977              | FM3577          | BRONZE    | SUNBURST          | 35              | EXT TH     | 177.0 | x | 109.0     | x | 2.4 | 6.97  | x | 4.29  | x | 0.094 |
| 731 42978              | FM3600MP        | STEEL     | -----             | 35              | INT TH     | 170.9 | x | 102.9     | x | 1.5 | 6.73  | x | 4.05  | x | 0.059 |
| 731 42979              | FM3602MP        | STEEL     | -----             | 35              | INT TH     | 170.9 | x | 102.9     | x | 2.0 | 6.73  | x | 4.05  | x | 0.079 |
| 731 42981              | FM3604MP        | STEEL     | -----             | 35              | INT TH     | 170.9 | x | 102.9     | x | 2.5 | 6.73  | x | 4.05  | x | 0.098 |
| 731 43004              | FM2277          | BRONZE    | SUNBURST          | 27              | EXT TH     | 137.4 | x | 90.9      | x | 2.0 | 5.41  | x | 3.58  | x | 0.079 |
| 731 43008              | FM3596MP        | STEEL     | -----             | 29              | INT TH     | 131.1 | x | 85.1      | x | 2.5 | 5.16  | x | 3.35  | x | 0.098 |
| 731 43009              | FM3594MP        | STEEL     | -----             | 29              | INT TH     | 131.1 | x | 85.1      | x | 2.0 | 5.16  | x | 3.35  | x | 0.079 |

| REPLACES<br>OEM PT.NO. | FMC<br>PART NO. | MATERIAL    | GROOVE<br>DETAILS | TEETH/<br>TANGS |            | SIZE MM |   |       |   | SIZE INCH |       |   |       |   |       |
|------------------------|-----------------|-------------|-------------------|-----------------|------------|---------|---|-------|---|-----------|-------|---|-------|---|-------|
| 731 72245              | FM6926MP        | STEEL       | HARDENED          | 48              | EXT TH     | 99.5    | x | 77.2  | x | 1.1       | 3.92  | x | 3.04  | x | 0.043 |
| 731 72246              | FM6923          | BRONZE      | WAFFLE            | 37              | INT TH     | 93.8    | x | 72.5  | x | 2.3       | 3.69  | x | 2.85  | x | 0.091 |
| 731 81966              | FM7215          | BRONZE      | WAFFLE            | 54              | EXT TH     | 109.5   | x | 81.6  | x | 1.9       | 4.31  | x | 3.21  | x | 0.075 |
| 731 86745              | FM5177          | BRONZE      | SPIRAL            | 27              | EXT TH     | 84.2    | x | 58.5  | x | 1.8       | 3.31  | x | 2.3   | x | 0.071 |
| 731 86746              | FM5180MP        | STEEL       | -----             | 28              | INT TH     | 76.7    | x | 54.2  | x | 1.0       | 3.02  | x | 2.13  | x | 0.039 |
| 749 07850              | FM1900MP        | STEEL       | -----             | 64              | EXT TH     | 205.5   | x | 145.3 | x | 1.7       | 8.09  | x | 5.72  | x | 0.067 |
| 752 11018              | FM6003          | OBSOLETE    | SUNBURST          | 95              | EXT TH     | 305.0   | x | 213.0 | x | 4.3       | 12.01 | x | 8.39  | x | 0.169 |
| 752 11723              | FM1635          | BRONZE      | SPR/RAD           | 64              | INT TH     | 356.0   | x | 198.0 | x | 7.1       | 14.02 | x | 7.8   | x | 0.28  |
| 752 86048              | FM4125          | BRONZE      | SUN-PLAIN         | 35              | EXT TH     | 177.5   | x | 109.0 | x | 1.6       | 6.99  | x | 4.29  | x | 0.063 |
| 752 87533              | FM2995          | PAPER       | 2 PASS            | 54              | INT TH     | 325.0   | x | 224.0 | x | 4.5       | 12.8  | x | 8.82  | x | 0.177 |
| 752 87534              | FM3630MP        | STEEL       | -----             | 75              | EXT TH     | 345.0   | x | 243.0 | x | 3.9       | 13.58 | x | 9.57  | x | 0.154 |
| 752 87535              | FM3632MP        | STEEL       | -----             | 75              | EXT TH     | 345.0   | x | 243.0 | x | 4.2       | 13.58 | x | 9.57  | x | 0.165 |
| 752 87536              | FM4024MP        | STEEL       | -----             | 75              | EXT TH     | 345.0   | x | 243.0 | x | 2.5       | 13.58 | x | 9.57  | x | 0.098 |
| 752 87537              | FM3636MP        | STEEL       | -----             | 75              | EXT TH     | 345.0   | x | 243.0 | x | 5.0       | 13.58 | x | 9.57  | x | 0.197 |
| 752 87609              | FM2997          | PAPER       | 2 PASS            | 72              | INT TH     | 298.0   | x | 215.0 | x | 4.5       | 11.73 | x | 8.46  | x | 0.177 |
| 752 87610              | FM3640MP        | STEEL       | -----             | 75              | EXT TH     | 315.0   | x | 226.0 | x | 3.9       | 12.4  | x | 8.9   | x | 0.154 |
| 752 87611              | FM3644MP        | STEEL       | -----             | 75              | EXT TH     | 315.0   | x | 226.0 | x | 4.5       | 12.4  | x | 8.9   | x | 0.177 |
| 752 87612              | FM3642MP        | STEEL       | -----             | 75              | EXT TH     | 315.0   | x | 226.0 | x | 4.3       | 12.4  | x | 8.9   | x | 0.167 |
| 752 87613              | FM3646MP        | STEEL       | -----             | 75              | EXT TH     | 315.0   | x | 226.0 | x | 5.0       | 12.4  | x | 8.9   | x | 0.197 |
| 753 11443              | FM4785          | PAPER/PLAIN | RADIAL            | 34              | EXT TH     | 177.4   | x | 111.5 | x | 1.9       | 6.98  | x | 4.39  | x | 0.075 |
| 753 11444              | FM4783          | CARBON PA   | RADIAL            | 34              | EXT TH     | 177.4   | x | 111.5 | x | 2.5       | 6.98  | x | 4.39  | x | 0.098 |
| 753 11445              | FM4786MP        | STEEL       | -----             | 42              | INT TH     | 167.8   | x | 102.5 | x | 2.5       | 6.61  | x | 4.04  | x | 0.098 |
| 753 11475              | FM4789          | PAPER/PLAIN | RADIAL            | 44              | EXT TH     | 158.8   | x | 111.5 | x | 1.9       | 6.25  | x | 4.39  | x | 0.075 |
| 753 11476              | FM4787          | CARBON PA   | RADIAL            | 44              | EXT TH     | 158.8   | x | 111.5 | x | 2.5       | 6.25  | x | 4.39  | x | 0.098 |
| 753 11477              | FM4790MP        | STEEL       | -----             | 42              | INT TH     | 150.9   | x | 102.5 | x | 2.5       | 5.94  | x | 4.04  | x | 0.098 |
| 753 11816              | FM6111          | CARBON PA   | RADIAL            | 27              | EXT TH     | 137.0   | x | 93.7  | x | 2.5       | 5.39  | x | 3.69  | x | 0.098 |
| 753 11817              | FM6113          | PAPER/PLAIN | RADIAL            | 27              | EXT TH     | 137.0   | x | 93.7  | x | 1.9       | 5.39  | x | 3.69  | x | 0.073 |
| 752 87708              | FM3813          | TAN PAPER   | 2 PASS            | 50              | (52) IN TH | 148.6   | x | 107.7 | x | 2.7       | 5.85  | x | 4.24  | x | 0.108 |
| 760 22138              | FM1359          | BRONZE      | SPIRAL            | 45              | INT TH     | 133.1   | x | 92.7  | x | 1.6       | 5.24  | x | 3.65  | x | 0.063 |
| 760 22157              | FM1324MP        | STEEL       | -----             | 54              | EXT TH     | 139.2   | x | 98.6  | x | 1.8       | 5.48  | x | 3.88  | x | 0.07  |
| 760 33959              | FM2995          | PAPER       | 2 PASS            | 54              | INT TH     | 325.0   | x | 224.0 | x | 4.5       | 12.8  | x | 8.82  | x | 0.177 |
| 760 33977              | FM2996KIT       | STEEL       | 4 PLATES          | 75              | EXT TH     | 345.0   | x | 243.0 | x | 4.5       | 13.58 | x | 9.57  | x | .177  |
| 760 33990              | FM2997          | PAPER       | 2 PASS            | 72              | INT TH     | 298.0   | x | 215.0 | x | 4.5       | 11.73 | x | 8.46  | x | 0.177 |
| 760 34001              | FM3644MP        | STEEL       | -----             | 75              | EXT TH     | 315.0   | x | 226.0 | x | 4.5       | 12.4  | x | 8.9   | x | 0.177 |
| 760 36047              | FM2991          | PAPER       | 3 PASS            | 57              | INT TH     | 360.0   | x | 237.0 | x | 4.5       | 14.17 | x | 9.33  | x | 0.177 |
| 760 43023              | FM4206MP        | STEEL       | -----             | 68              | EXT TH     | 173.9   | x | 113.0 | x | 1.7       | 6.85  | x | 4.45  | x | 0.067 |
| 760 43024              | FM4265          | PAPER       | WAFFLE            | 52              | INT TH     | 160.0   | x | 107.5 | x | 2.2       | 6.3   | x | 4.23  | x | 0.087 |
| 760 43194              | FM4375          | PAPER       | WAFFLE            | 33              | INT TH     | 400.0   | x | 122.5 | x | 6.2       | 15.75 | x | 4.82  | x | 0.244 |
| 760 43195              | FM4378MP        | STEEL       | -----             | 8               | EXT LG     | 418.6   | x | 312.0 | x | 5.0       | 16.48 | x | 12.28 | x | 0.197 |
| 760 45016              | FM4317          | PAPER       | WAFFLE            | 33              | INT TH     | 344.0   | x | 122.5 | x | 6.2       | 13.54 | x | 4.82  | x | 0.244 |
| 760 45017              | FM4320MP        | STEEL       | -----             | 8               | EXT LG     | 358.5   | x | 264.0 | x | 5.0       | 10.18 | x | 10.39 | x | 0.197 |
| 760 48137              | FM2991          | PAPER       | 3 PASS            | 57              | INT TH     | 360.0   | x | 237.0 | x | 4.5       | 14.17 | x | 9.33  | x | 0.177 |
| 760 49200              | FM4203          | PAPER       | 2 PASS            | 52              | INT TH     | 160.0   | x | 107.5 | x | 2.2       | 6.3   | x | 4.23  | x | 0.087 |
| 760 54227              | FM4380MP        | STEEL       | -----             | 8               | EXT LG     | 418.6   | x | 312.0 | x | 10.0      | 16.48 | x | 12.28 | x | 0.394 |
| 760 68777              | FM4322MP        | STEEL       | -----             | 8               | EXT SL     | 358.5   | x | 210.0 | x | 10.0      | 10.18 | x | 8.27  | x | 0.394 |
| 760 81203              | FM4785          | PAPER/PLAIN | RADIAL            | 34              | EXT TH     | 177.4   | x | 111.5 | x | 1.9       | 6.98  | x | 4.39  | x | 0.075 |
| 760 81024              | FM4783          | CARBON PA   | RADIAL            | 34              | EXT TH     | 177.4   | x | 111.5 | x | 2.5       | 6.98  | x | 4.39  | x | 0.098 |

| REPLACES<br>OEM PT.NO. | FMC<br>PART NO. | MATERIAL             | GROOVE<br>DETAILS | TEETH/<br>TANGS | SIZE MM   | SIZE INCH                                  |
|------------------------|-----------------|----------------------|-------------------|-----------------|-----------|--|
| 760 87543              | FM8733          | MOLYBDENUM           | RADIAL            | 36              | INT TH    | 149.0 x 71.3 x 3.0 5.87 x 2.81 x 0.118     |
| 760 87703              | FM4378MP        | STEEL                | -----             | 8               | EXT LG    | 418.6 x 312.0 x 5.0 16.48 x 12.28 x 0.197  |
| 760 87704              | FM4380MP        | STEEL                | -----             | 8               | EXT LG    | 418.6 x 312.0 x 10.0 16.48 x 12.28 x 0.394 |
| 760 87705              | FM4322MP        | STEEL                | -----             | 8               | EXT SL    | 358.5 x 210.0 x 10.0 10.18 x 8.27 x 0.394  |
| 760 87706              | FM4320MP        | STEEL                | -----             | 8               | EXT LG    | 358.5 x 264.0 x 5.0 10.18 x 10.39 x 0.197  |
| 785 11010              | FM1617          | BRONZE               | SPR/WAG           | 95              | EXT TH    | 304.8 x 212.9 x 4.3 12.0 x 8.38 x 0.168    |
| 790 03496              | FM5305          | BRONZE               | SUNBURST          | 74              | EXT TH    | 188.0 x 138.0 x 3.2 7.4 x 5.43 x 0.126     |
| 790 10056              | FM3153          | OBSOLETE AFTER STOCK |                   | 68              | EXT TH    | 208.0 x 145.0 x 3.5 8.19 x 5.71 x 0.138    |
| 790 17821              | FM2705B         | BRONZE               | SUNBURST          | 93              | EXT TH    | 239.8 x 171.6 x 3.5 9.44 x 6.76 x 0.138    |
| 790 19030              | FM2705B         | BRONZE               | SUNBURST          | 93              | EXT TH    | 239.8 x 171.6 x 3.5 9.44 x 6.76 x 0.138    |
| 790 30951              | FM3424MP        | STEEL                | -----             | 54              | INT TH    | 228.0 x 150.0 x 2.5 8.98 x 5.91 x 0.098    |
| 790 30952              | FM4042MP        | OBSOLETE AFTER STOCK |                   | 54              | INT TH    | 228.0 x 150.0 x 2.5 8.98 x 5.91 x 0.098    |
| 790 31021              | FM4654MP        | OBSOLETE AFTER STOCK |                   | 54              | INT TH    | 228.0 x 150.0 x 3.0 8.98 x 5.91 x 0.118    |
| 790 33092              | FM8739          | MOLYBDENUM           | RADIAL            | 26              | INT TH    | 129.3 x 63.3 x 3.0 5.09 x 2.49 x 0.116     |
| 790 33092A             | FM8737          | MOLYBDENUM           | RADIAL            | 26              | INT TH    | 129.3 x 63.3 x 3.9 5.09 x 2.49 x 0.152     |
| 790 39484              | FM1635          | BRONZE               | SPR/WAG           | 64              | INT TH    | 355.6 x 200.2 x 7.1 14 x 7.88 x 0.28       |
| 790 40802              | FM3236MP        | STEEL                | -----             | 45              | INT TH    | 195.0 x 121.0 x 2.5 7.68 x 4.76 x 0.098    |
| 790 40803              | FM8358MP        | OBSOLETE AFTER STOCK |                   | 45              | INT TH    | 195.0 x 121.0 x 3.5 7.68 x 4.76 x 0.138    |
| 790 41661              | OBSOLETE        | BRONZE               | -----             | 50              | INT TH    | 305.0 x 156.0 x 7.1 12.01 x 6.14 x 0.28    |
| 790 41947              | FM3236MP        | STEEL                | -----             | 45              | INT TH    | 195.0 x 121.0 x 2.5 7.68 x 4.76 x 0.098    |
| 790 42697              | FM4615          | PAPER                | 2 PASS            | 34              | INT TH    | 130.0 x 85.0 x 2.5 5.12 x 3.35 x 0.098     |
| 790 42698              | FM4220MP        | STEEL                | -----             | 35              | EXT TH    | 138.6 x 90.5 x 1.6 5.46 x 3.56 x 0.063     |
| 790 43722              | FM2705B         | BRONZE               | SUNBURST          | 93              | EXT TH    | 239.8 x 171.6 x 3.5 9.44 x 6.76 x 0.138    |
| 790 44332              | FM7184MP        | STEEL                | -----             | 45              | INT TH    | 180.0 x 115.0 x 2.0 7.09 x 4.53 x 0.079    |
| 790 44333              | FM4944MP        | OBSOLETE             | -----             | 45              | INT TH    | 180.0 x 115.0 x 2.5 7.09 x 4.53 x 0.098    |
| 790 44334              | FM8355          | OBSOLETE AFTER STOCK |                   | 74              | EXT TH    | 188.0 x 138.0 x 3.2 7.4 x 5.43 x 0.126     |
| 790 49944              | FM2840MP        | STEEL                | -----             | 67              | INT TH    | 290.1 x 195.1 x 2.5 11.42 x 7.68 x 0.098   |
| 790 57506              | FM3153          | OBSOLETE AFTER STOCK |                   | 68              | EXT TH    | 208.0 x 145.0 x 3.5 8.19 x 5.71 x 0.138    |
| 790 59369              | FM3592MP        | STEEL                | -----             | 29              | INT TH    | 131.1 x 85.1 x 1.5 5.16 x 3.35 x 0.059     |
| 790 66329              | FM4213          | CARBON PA            | SUNBURST          | 122             | EXT TH    | 370.0 x 280.0 x 4.8 14.57 x 11.02 x 0.189  |
| 790 72843              | FM3021          | BRONZE               | SUNBURST          | 87              | INT TH    | 306.0 x 258.0 x 3.0 12.05 x 10.16 x 0.118  |
| 790 72917              | FM2277          | BRONZE               | SUNBURST          | 27              | EXT TH    | 137.4 x 90.9 x 2.0 5.41 x 3.58 x 0.079     |
| 790 72918              | FM2279          | BRONZE               | SUNBURST          | 35              | EXT TH    | 177.5 x 109.0 x 2.0 6.99 x 4.29 x 0.079    |
| 790 77033              | FM8735          | MOLYBDENUM           | RADIAL            | 36              | INT TH    | 149.0 x 71.3 x 4.0 5.87 x 2.81 x 0.156     |
| 790 77633              | FM6003          | OBSOLETE             | SUNBURST          | 95              | EXT TH    | 305.0 x 213.0 x 4.3 12.01 x 8.39 x 0.169   |
| 790 79550              | FM3017          | BRONZE               | SUNBURST          | 68              | EXT TH    | 208.0 x 145.0 x 3.5 8.19 x 5.71 x 0.138    |
| 790 90493              | FM1635          | BRONZE               | SPR/WAG           | 64              | INT TH    | 355.6 x 200.2 x 7.1 14.0 x 7.88 x 0.28     |
| 791 08023              | FM2277          | BRONZE               | SUNBURST          | 27              | EXT TH    | 137.4 x 90.9 x 2.0 5.41 x 3.58 x 0.079     |
| 791 10783              | FM3021          | BRONZE               | SUNBURST          | 87              | INT TH    | 306.0 x 258.0 x 3.0 12.05 x 10.16 x 0.118  |
| 791 11859              | FM4123          | BRONZE               | SUN-PLAIN         | 27              | EXT TH    | 137.4 x 90.9 x 1.6 5.41 x 3.58 x 0.063     |
| <b>FIORI</b>           |                 |                      |                   |                 |           |  |
| 52020                  | FM4015          | GRAPHITE             | SUNBURST          | 27              | INT TH    | 303.8 x 66.1 x 10.0 11.96 x 2.6 x 0.393    |
| <b>FORD</b>            |                 |                      |                   |                 |           |  |
| 1P77518A               | FM1276MP        | STEEL                | DISHED            | 50              | (54)EX TH | 138.9 x 98.0 x 1.8 5.47 x 3.86 x 0.07      |
| 1P77519A               | FM1359          | BRONZE               | SPIRAL            | 45              | INT TH    | 133.1 x 92.7 x 1.6 5.24 x 3.65 x 0.063     |
| CONN7B164A             | FM1359          | BRONZE               | SPIRAL            | 45              | INT TH    | 133.1 x 92.7 x 1.6 5.24 x 3.65 x 0.063     |



# Agricultural Discs

---

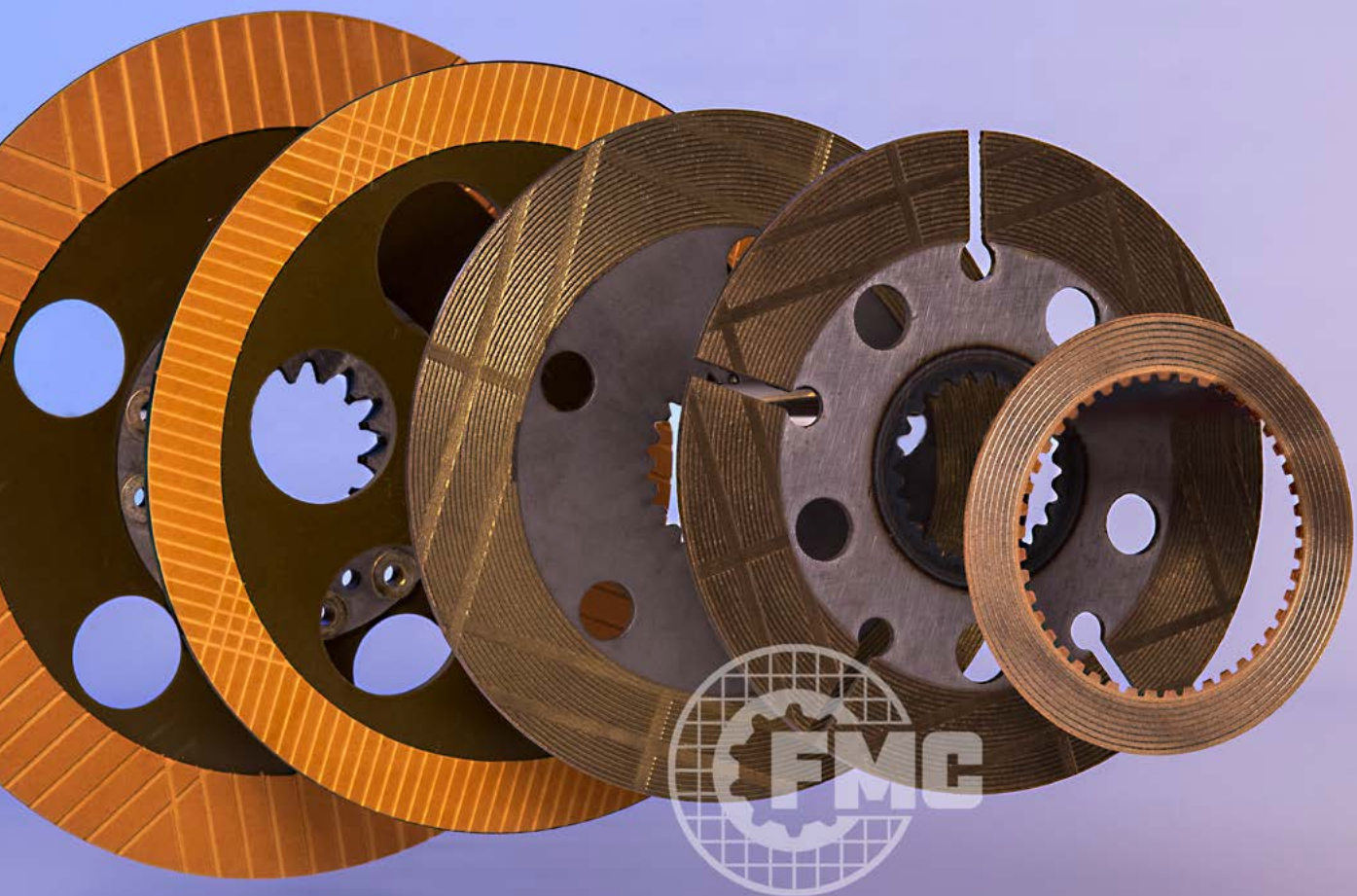



| REPLACES<br>OEM PT.NO. | FMC<br>PART NO. | MATERIAL   | GROOVE<br>DETAILS | TEETH/<br>TANGS |           | SIZE MM |   |       | SIZE INCH |     |       |   |      |   |       |
|------------------------|-----------------|------------|-------------------|-----------------|-----------|---------|---|-------|-----------|-----|-------|---|------|---|-------|
| C0NN7B164B             | FM1341B         | BRONZE     | SPR/RAD           | 52              | INT TH    | 148.6   | x | 107.4 | x         | 2.3 | 5.85  | x | 4.23 | x | 0.09  |
| C0NN7B164D             | FM1361          | BRONZE     | SUNBURST          | 45              | INT TH    | 133.1   | x | 92.7  | x         | 1.6 | 5.24  | x | 3.65 | x | 0.063 |
| C0NN7B442A             | FM3696MP        | STEEL      | -----             | 60              | EXT TH    | 154.2   | x | 113.8 | x         | 2.2 | 6.07  | x | 4.48 | x | 0.087 |
| C5NN2A097A             | FM1591          | BRONZE     | SPR/WAG           | 22              | INT TH    | 224.0   | x | 53.3  | x         | 4.8 | 8.82  | x | 2.1  | x | 0.19  |
| C5NN2A097B             | FM1705          | BRONZE     | SPR/WAG           | 22              | INT TH    | 204.5   | x | 53.3  | x         | 4.8 | 8.05  | x | 2.1  | x | 0.19  |
| C5NN2N315A             | FM1190MP        | STEEL      | -----             | 1               | EXT LG    | 228.6   | x | 127.0 | x         | 2.6 | 9.0   | x | 5.0  | x | 0.102 |
| C5NN2N315B             | FM1202MP        | STEEL      | -----             | 1               | EXT LG    | 209.3   | x | 114.3 | x         | 2.7 | 8.24  | x | 4.5  | x | 0.106 |
| C9NN7R004A             | FM4564MP        | STEEL      | -----             | 15              | EXT LG    | 239.4   | x | 190.5 | x         | 3.0 | 9.43  | x | 7.5  | x | 0.118 |
| C5NNN743A              | FM1698MP        | STEEL      | -----             | 45              | INT TH    | 133.4   | x | 93.0  | x         | 1.7 | 5.25  | x | 3.66 | x | 0.066 |
| C5NNP743A              | FM1657B         | BRONZE     | SPR/RAD           | 45              | INT TH    | 133.4   | x | 92.7  | x         | 2.1 | 5.25  | x | 3.65 | x | 0.082 |
| C5NNP743B              | FM1657B         | BRONZE     | SPR/RAD           | 45              | INT TH    | 133.4   | x | 92.7  | x         | 2.1 | 5.25  | x | 3.65 | x | 0.082 |
| C7NN2A097B             | FM1591          | BRONZE     | SPR/WAG           | 22              | INT TH    | 224.0   | x | 53.3  | x         | 4.8 | 8.82  | x | 2.1  | x | 0.19  |
| C7NN7B442A             | FM1304MP        | STEEL      | -----             | 40              | (52)EX TH | 170.9   | x | 130.3 | x         | 1.4 | 6.73  | x | 5.13 | x | 0.055 |
| C8AP7B442A             | FM1324MP        | STEEL      | -----             | 54              | EXT TH    | 139.2   | x | 98.6  | x         | 1.8 | 5.48  | x | 3.88 | x | 0.07  |
| C9NN7R024B             | FM4006MP        | STEEL      | -----             | 15              | EXT LG    | 248.8   | x | 218.4 | x         | 2.0 | 9.8   | x | 8.6  | x | 0.08  |
| C9NN7R025A             | FM4004MP        | STEEL      | -----             | 15              | EXT LG    | 248.8   | x | 190.5 | x         | 2.5 | 9.8   | x | 7.5  | x | 0.098 |
| C9NNP743A              | FM1593          | BRONZE     | SUNBURST          | 52              | INT TH    | 148.6   | x | 107.4 | x         | 2.3 | 5.85  | x | 4.23 | x | 0.09  |
| C9NNP743B              | FM1657B         | BRONZE     | SPR/RAD           | 45              | INT TH    | 133.4   | x | 92.7  | x         | 2.1 | 5.25  | x | 3.65 | x | 0.082 |
| C9NNP743C              | FM1341B         | BRONZE     | SPR/RAD           | 52              | INT TH    | 148.6   | x | 107.4 | x         | 2.3 | 5.85  | x | 4.23 | x | 0.09  |
| C9NNP743D              | FM1593          | BRONZE     | SUNBURST          | 52              | INT TH    | 148.6   | x | 107.4 | x         | 2.3 | 5.85  | x | 4.23 | x | 0.09  |
| C9NNP743E              | FM1341B         | BRONZE     | SPR/RAD           | 52              | INT TH    | 148.6   | x | 107.4 | x         | 2.3 | 5.85  | x | 4.23 | x | 0.09  |
| D1NNP743A              | FM1593          | BRONZE     | SUNBURST          | 52              | INT TH    | 148.6   | x | 107.4 | x         | 2.3 | 5.85  | x | 4.23 | x | 0.09  |
| D2NN2A097A             | FM1377          | BRONZE     | SPR/WAG           | 23              | INT TH    | 152.4   | x | 35.6  | x         | 4.8 | 6.0   | x | 1.4  | x | 0.19  |
| D2NN7R000A             | FM4077          | BRONZE     | SUNBURST          | 80              | INT TH    | 229.1   | x | 168.4 | x         | 2.0 | 9.02  | x | 6.63 | x | 0.079 |
| D2NN7R174A             | FM1216MP        | STEEL      | -----             | 60              | EXT TH    | 154.2   | x | 113.8 | x         | 1.8 | 6.07  | x | 4.48 | x | 0.07  |
| D2NN7R175A             | FM1305OE        | BRONZE     | RADIAL            | 52              | INT TH    | 148.6   | x | 107.7 | x         | 2.6 | 5.85  | x | 4.24 | x | 0.102 |
| D3NNP743A              | FM1593          | BRONZE     | SUNBURST          | 52              | INT TH    | 148.6   | x | 107.4 | x         | 2.3 | 5.85  | x | 4.23 | x | 0.09  |
| ALTERNATIVE            | FM1341B         | BRONZE     | SPR/RAD           | 52              | INT TH    | 148.6   | x | 107.4 | x         | 2.3 | 5.85  | x | 4.23 | x | 0.09  |
| D4NN7A405A             | FM0541          | BRONZE     | SUNBURST          | 38              | INT TH    | 162.6   | x | 120.9 | x         | 2.3 | 6.4   | x | 4.76 | x | 0.09  |
| D5NN2A097A             | FM4007          | GRAPHITE   | SUNBURST          | 17              | INT TH    | 368.0   | x | 79.0  | x         | 9.6 | 14.49 | x | 3.11 | x | 0.376 |
| D6NNC730A              | FM1216MP        | STEEL      | -----             | 60              | EXT TH    | 154.2   | x | 113.8 | x         | 1.8 | 6.07  | x | 4.48 | x | 0.07  |
| D8NNP743GA             | FM5799          | GRAPHITE   | SUNBURST          | 52              | INT TH    | 192.0   | x | 107.0 | x         | 2.8 | 7.56  | x | 4.21 | x | 0.109 |
| D8NNP743JA             | FM1593          | BRONZE     | SUNBURST          | 52              | INT TH    | 148.6   | x | 107.4 | x         | 2.3 | 5.85  | x | 4.23 | x | 0.09  |
| D8NNP743JA             | FM4613          | GRAPHITE   | SUNBURST          | 52              | INT TH    | 148.6   | x | 107.4 | x         | 2.3 | 5.85  | x | 4.23 | x | 0.09  |
| D9NN7B164AA            | FM3819          | BRONZE     | SPIRAL            | 45              | INT TH    | 133.1   | x | 92.7  | x         | 2.4 | 5.24  | x | 3.65 | x | 0.096 |
| E0NNB726AA             | FM1793          | PAPER      | -----             |                 | BRK BAND  | 210.1   | x | 19.1  | x         | 1.5 | 8.27  | x | 0.75 | x | 0.058 |
| E0NNB726AB             | FM1793          | PAPER      | -----             |                 | BRK BAND  | 210.1   | x | 19.1  | x         | 1.5 | 8.27  | x | 0.75 | x | 0.058 |
| E0NN7R000AB            | FM4001          | BRONZE     | WAF/RAD           | 80              | INT TH    | 229.1   | x | 168.4 | x         | 4.5 | 9.02  | x | 6.63 | x | 0.177 |
| E0NN7Z031AA            | FM1381OE        | BRONZE     | RADIAL            | 52              | INT TH    | 148.6   | x | 107.7 | x         | 2.9 | 5.85  | x | 4.24 | x | 0.114 |
| E0NNP743AA             | FM1657B         | BRONZE     | SPR/RAD           | 45              | INT TH    | 133.4   | x | 93.0  | x         | 2.1 | 5.25  | x | 3.66 | x | 0.083 |
| E1NN7A567AA            | FM4066MP        | STEEL      | -----             | 32              | INT TH    | 131.5   | x | 64.0  | x         | 1.5 | 5.18  | x | 2.52 | x | 0.058 |
| E2NN3N259DA            | FM8999          | MOLYBDENUM | -----             | 36              | INT TH    | 71.7    | x | 44.8  | x         | 1.5 | 2.82  | x | 1.76 | x | 0.059 |
| E5NNP743AA             | FM1593          | BRONZE     | SUNBURST          | 52              | INT TH    | 148.6   | x | 107.4 | x         | 2.3 | 5.85  | x | 4.23 | x | 0.09  |
| E6NN2A097AA            | FM2217          | BRONZE     | SPR/WAG           | 22              | INT TH    | 224.0   | x | 53.3  | x         | 4.8 | 8.82  | x | 2.1  | x | 0.19  |
| E6NN2A097BB            | FM3035          | PAPER      | WAFFLE            | 22              | INT TH    | 204.5   | x | 53.3  | x         | 4.8 | 8.05  | x | 2.1  | x | 0.189 |
| E6NN2N315AA            | FM2372MP        | STEEL      | -----             | 1               | EXT LG    | 228.6   | x | 146.1 | x         | 2.6 | 9.0   | x | 5.75 | x | 0.102 |
| E6NN2N315BB            | FM3038MP        | STEEL      | -----             | 1               | EXT SL    | 236.0   | x | 85.0  | x         | 2.7 | 9.29  | x | 3.35 | x | 0.106 |

| REPLACES<br>OEM PT.NO. | FMC<br>PART NO. | MATERIAL | GROOVE<br>DETAILS | TEETH/<br>TANGS | SIZE MM   | SIZE INCH                                 |
|------------------------|-----------------|----------|-------------------|-----------------|-----------|---|
| E6NN7B442AA            | FM3698MP        | STEEL    | -----             | 60              | EXT TH    | 154.2 x 113.8 x 2.6 6.07 x 4.48 x 0.1     |
| E6SP7E314AA            | FM8168MP        | STEEL    | -----             | 34              | EXT TH    | 153.9 x 119.8 x 1.8 6.06 x 4.72 x 0.071   |
| E7NN2A097AA            | FM2217          | BRONZE   | SPR/WAG           | 22              | INT TH    | 224.0 x 53.3 x 4.8 8.82 x 2.1 x 0.19      |
| E8NN2A097AA            | FM2217          | BRONZE   | SPR/WAG           | 22              | INT TH    | 224.0 x 53.3 x 4.8 8.82 x 2.1 x 0.19      |
| E9NN2A097AA            | FM2215          | BRONZE   | SPR/WAG           | 22              | INT TH    | 204.5 x 53.3 x 4.8 8.05 x 2.1 x 0.19      |
| E9NN2A097BA            | FM2217          | BRONZE   | SPR/WAG           | 22              | INT TH    | 224.0 x 53.3 x 4.8 8.82 x 2.1 x 0.19      |
| E9NN2N315CB            | FM2954MP        | STEEL    | -----             | 4               | EXT LG    | 228.5 x 147.0 x 2.7 9.0 x 5.79 x 0.106    |
| F0NN2N315AA            | FM2640MP        | STEEL    | -----             | 1               | EXT SL    | 209.2 x 124.0 x 4.5 8.24 x 4.88 x 0.177   |
| F0NN7H095AA            | FM8165          | PAPER    | 1 PASS            | 63              | INT TH    | 143.4 x 115.2 x 1.7 5.65 x 4.54 x 0.068   |
| F0NN7H095AB            | FM8165          | PAPER    | 1 PASS            | 63              | INT TH    | 143.4 x 115.2 x 1.7 5.65 x 4.54 x 0.068   |
| F2NN7B442AA            | FM3214MP        | STEEL    | -----             | 66              | EXT TH    | 168.0 x 119.0 x 1.8 6.61 x 4.69 x 0.069   |
| P77573A1               | FM1324MP        | STEEL    | -----             | 54              | EXT TH    | 139.2 x 98.6 x 1.8 5.48 x 3.88 x 0.07     |
| PBB77519A              | FM1655          | BRONZE   | SUNBURST          | 52              | INT TH    | 148.6 x 107.4 x 1.6 5.85 x 4.23 x 0.062   |
| PBB77573A              | FM1216MP        | STEEL    | -----             | 60              | EXT TH    | 154.2 x 113.8 x 1.8 6.07 x 4.48 x 0.07    |
| ZP-2002202-019         | FM2277          | BRONZE   | SUNBURST          | 27              | EXT TH    | 137.4 x 90.9 x 2.0 5.41 x 3.58 x 0.079    |
| 261 789                | OBSOLETE        | BRONZE   | -----             | 27              | INT TH    | 174.6 x 82.6 x 6.7 6.88 x 3.25 x 0.265    |
| 180 2479               | FM1705          | BRONZE   | SPR/WAG           | 22              | INT TH    | 204.5 x 53.3 x 4.8 8.05 x 2.1 x 0.19      |
| 180 4831               | FM1359          | BRONZE   | SPIRAL            | 45              | INT TH    | 133.1 x 92.7 x 1.6 5.24 x 3.65 x 0.063    |
| 180 8604               | FM1276MP        | STEEL    | DISHED            | 50              | (54)EX TH | 138.9 x 98.0 x 1.8 5.47 x 3.86 x 0.07     |
| 181 6970               | FM1657B         | BRONZE   | SPR/RAD           | 45              | INT TH    | 133.4 x 92.7 x 2.1 5.25 x 3.65 x 0.082    |
| 183 0026               | FM1593          | BRONZE   | SUNBURST          | 52              | INT TH    | 148.6 x 107.4 x 2.3 5.85 x 4.23 x 0.09    |
| 395 5538               | FM1202MP        | STEEL    | -----             | 1               | EXT LG    | 209.3 x 114.3 x 2.7 8.24 x 4.5 x 0.106    |
| 81866478               | FM2954MP        | STEEL    | -----             | 4               | EXT LG    | 228.5 x 147.0 x 2.7 9 x 5.79 x 0.106      |
| <b>FRISCH-FAUN</b>     |                 |          |                   |                 |           |   |
| D310 564               | FM2678MP        | STEEL    | -----             | 44              | INT TH    | 162.0 x 105.0 x 2.3 6.38 x 4.13 x 0.091   |
| D310 565               | FM3523          | BRONZE   | SPR/RAD           | 68              | EXT TH    | 173.0 x 118.0 x 2.4 6.81 x 4.65 x 0.094   |
| D131 0564              | FM2678MP        | STEEL    | -----             | 44              | INT TH    | 162.0 x 105.0 x 2.3 6.38 x 4.13 x 0.091   |
| 4623 153               | FM2815          | PAPER    | 4 PASS            | 42              | INT TH    | 340.0 x 206.0 x 5.5 13.39 x 8.11 x 0.217  |
| 7381 130               | FM3594MP        | STEEL    | -----             | 29              | INT TH    | 131.1 x 85.1 x 2.0 5.16 x 3.35 x 0.079    |
| 7381 131               | FM3596MP        | STEEL    | -----             | 29              | INT TH    | 131.1 x 85.1 x 2.5 5.16 x 3.35 x 0.098    |
| 7381 132               | FM3592MP        | STEEL    | -----             | 29              | INT TH    | 131.1 x 85.1 x 1.5 5.16 x 3.35 x 0.059    |
| 7381 246               | FM3602MP        | STEEL    | -----             | 35              | INT TH    | 170.9 x 102.9 x 2.0 6.73 x 4.05 x 0.079   |
| 7381 248               | FM3600MP        | STEEL    | -----             | 35              | INT TH    | 170.9 x 102.9 x 1.5 6.73 x 4.05 x 0.059   |
| 7381 261               | FM3604MP        | STEEL    | -----             | 35              | INT TH    | 170.9 x 102.9 x 2.5 6.73 x 4.05 x 0.098   |
| 7382 519               | FM2277          | BRONZE   | SUNBURST          | 27              | EXT TH    | 137.4 x 90.9 x 2.0 5.41 x 3.58 x 0.079    |
| 7382 674               | FM2279          | BRONZE   | SUNBURST          | 35              | EXT TH    | 177.5 x 109.0 x 2.0 6.99 x 4.29 x 0.079   |
| 7391 576               | FM3024MP        | STEEL    | -----             | 12              | EXT LG    | 317.7 x 268.0 x 3.0 12.51 x 10.55 x 0.118 |
| 7391 575               | FM3021          | BRONZE   | SUNBURST          | 87              | INT TH    | 306.0 x 258.0 x 3.0 12.05 x 10.16 x 0.118 |
| 7395 157               | FM1381OE        | BRONZE   | RADIAL            | 52              | INT TH    | 148.6 x 107.7 x 2.9 5.85 x 4.24 x 0.114   |
| 7395 158               | FM1216MP        | STEEL    | -----             | 60              | EXT TH    | 154.2 x 113.8 x 1.8 6.07 x 4.48 x 0.07    |
| 7395 210               | FM1307OE        | BRONZE   | RADIAL            | 52              | INT TH    | 148.6 x 107.7 x 2.6 5.85 x 4.24 x 0.102   |
| 7396 255               | FM2811          | PAPER    | 4 PASS            | 34              | INT TH    | 277.0 x 167.0 x 4.5 10.91 x 6.57 x 0.177  |
| 8010 585               | FM3024MP        | STEEL    | -----             | 12              | EXT LG    | 317.7 x 268.0 x 3.0 12.51 x 10.55 x 0.118 |
| 738 056 050            | FM2279          | BRONZE   | SUNBURST          | 35              | EXT TH    | 177.5 x 109.0 x 2.0 6.99 x 4.29 x 0.079   |
| 738 113 050            | FM3594MP        | STEEL    | -----             | 29              | INT TH    | 131.1 x 85.1 x 2.0 5.16 x 3.35 x 0.079    |
| 738 113 250            | FM3592MP        | STEEL    | -----             | 29              | INT TH    | 131.1 x 85.1 x 1.5 5.16 x 3.35 x 0.059    |

| REPLACES<br>OEM PT.NO.    | FMC<br>PART NO. | MATERIAL  | GROOVE<br>DETAILS | TEETH/<br>TANGS | SIZE MM    |       |   | SIZE INCH |   |     |       |   |      |   |       |
|---------------------------|-----------------|-----------|-------------------|-----------------|------------|-------|---|-----------|---|-----|-------|---|------|---|-------|
| 738 124 650               | FM2277          | BRONZE    | SUNBURST          | 27              | EXT TH     | 137.4 | x | 90.9      | x | 2.0 | 5.41  | x | 3.58 | x | 0.079 |
| 738 125 150               | FM3604MP        | STEEL     | -----             | 35              | INT TH     | 170.9 | x | 102.9     | x | 2.5 | 6.73  | x | 4.05 | x | 0.098 |
| 738 156 750               | FM3602MP        | STEEL     | -----             | 35              | INT TH     | 170.9 | x | 102.9     | x | 2.0 | 6.73  | x | 4.05 | x | 0.079 |
| <b>FUNK</b>               |                 |           |                   |                 |            |       |   |           |   |     |       |   |      |   |       |
| 409863                    | FM6991          | BRONZE    | RADIAL            | 60              | INT TH     | 169.0 | x | 124.6     | x | 3.3 | 6.65  | x | 4.91 | x | 0.128 |
| 4002022                   | FM1279          | PAPER     | 2 PASS            | 52              | INT TH     | 148.6 | x | 107.7     | x | 1.8 | 5.85  | x | 4.24 | x | 0.07  |
| 4002254                   | FM2448MP        | STEEL     | -----             | 60              | EXT TH     | 154.2 | x | 113.8     | x | 3.1 | 6.07  | x | 4.48 | x | 0.123 |
| 4002787                   | FM1279          | PAPER     | 2 PASS            | 52              | INT TH     | 148.6 | x | 107.7     | x | 1.8 | 5.85  | x | 4.24 | x | 0.07  |
| 4004896                   | FM4251          | PAPER     | WAFFLE            | 45              | INT TH     | 133.1 | x | 92.7      | x | 1.9 | 5.24  | x | 3.65 | x | 0.73  |
| 4005522                   | FM1279          | PAPER     | 2 PASS            | 52              | INT TH     | 148.6 | x | 107.7     | x | 1.8 | 5.85  | x | 4.24 | x | 0.07  |
| 4005523                   | FM3813          | TAN PAPER | 2 PASS            | 50              | (52) IN TH | 148.6 | x | 107.7     | x | 2.7 | 5.85  | x | 4.24 | x | 0.108 |
| 4005523                   | FM5295          | GREEN PA  | 2 PASS            | 50              | (52) IN TH | 148.6 | x | 107.7     | x | 2.7 | 5.85  | x | 4.24 | x | 0.108 |
| 4005524                   | FM4251          | PAPER     | WAFFLE            | 45              | INT TH     | 133.1 | x | 92.7      | x | 1.9 | 5.24  | x | 3.65 | x | 0.73  |
| 4005527                   | FM2029          | PAPER     | 2 PASS            | 52              | INT TH     | 148.6 | x | 107.7     | x | 2.9 | 5.85  | x | 4.24 | x | 0.114 |
| 4012382                   | FM1216MP        | STEEL     | -----             | 60              | EXT TH     | 154.2 | x | 113.8     | x | 1.8 | 6.07  | x | 4.48 | x | 0.07  |
| 4050498                   | FM1359          | BRONZE    | SPIRAL            | 45              | INT TH     | 133.1 | x | 92.7      | x | 1.6 | 5.24  | x | 3.65 | x | 0.063 |
| 40121315                  | FM1279          | PAPER     | 2 PASS            | 52              | INT TH     | 148.6 | x | 107.7     | x | 1.8 | 5.85  | x | 4.24 | x | 0.07  |
| 40121323                  | FM1216MP        | STEEL     | -----             | 60              | EXT TH     | 154.2 | x | 113.8     | x | 1.8 | 6.07  | x | 4.48 | x | 0.07  |
| 40RC-7683                 | FM1359          | BRONZE    | SPIRAL            | 45              | INT TH     | 133.1 | x | 92.7      | x | 1.6 | 5.24  | x | 3.65 | x | 0.063 |
| 40RC-7727                 | FM1276MP        | STEEL     | DISHED            | 50              | (54)EX TH  | 138.9 | x | 98.0      | x | 1.8 | 5.47  | x | 3.86 | x | 0.07  |
| 40RC-7951                 | FM1324MP        | STEEL     | -----             | 54              | EXT TH     | 139.2 | x | 98.6      | x | 1.8 | 5.48  | x | 3.88 | x | 0.07  |
| 4TRC-7173                 | FM1276MP        | STEEL     | DISHED            | 50              | (54)EX TH  | 138.9 | x | 98.0      | x | 1.8 | 5.47  | x | 3.86 | x | 0.07  |
| 4TRC-7174                 | FM1359          | BRONZE    | SPIRAL            | 45              | INT TH     | 133.1 | x | 92.7      | x | 1.6 | 5.24  | x | 3.65 | x | 0.063 |
| YZ90355                   | FM1202MP        | STEEL     | -----             | 1               | EXT LG     | 209.3 | x | 114.3     | x | 2.7 | 8.24  | x | 4.5  | x | 0.106 |
| YZ100952                  | FM6148MP        | STEEL     | -----             | 8               | EXT LG     | 209.6 | x | 138.3     | x | 3.0 | 8.25  | x | 5.44 | x | 0.118 |
| YZ101333                  | FM5926MP        | STEEL     | -----             | 69              | EXT TH     | 177.0 | x | 132.0     | x | 1.9 | 6.97  | x | 5.2  | x | 0.075 |
| YZ101337                  | FM5923          | PAPER     | 2 PASS            | 60              | INT TH     | 169.0 | x | 124.6     | x | 2.8 | 6.65  | x | 4.91 | x | 0.11  |
| YZ102943                  | FM5929          | PAPER     | 2 PASS            | 52              | INT TH     | 170.0 | x | 107.0     | x | 2.9 | 6.69  | x | 4.21 | x | 0.114 |
| YZ103269                  | FM6991          | BRONZE    | RADIAL            | 60              | INT TH     | 169.0 | x | 124.6     | x | 3.3 | 6.65  | x | 4.91 | x | 0.128 |
| YZ104717                  | FM8118MP        | STEEL     | END PLATE         | 69              | EXT TH     | 176.0 | x | 131.9     | x | 6.2 | 6.93  | x | 5.19 | x | 0.244 |
| YZ104908                  | FM5932MP        | STEEL     | -----             | 69              | EXT TH     | 177.0 | x | 114.0     | x | 2.0 | 6.97  | x | 4.49 | x | 0.077 |
| YZ105481                  | FM3813          | TAN PAPER | 2 PASS            | 50              | (52) IN TH | 148.6 | x | 107.7     | x | 2.7 | 5.85  | x | 4.24 | x | 0.108 |
| YZ105481                  | FM5295          | GREEN PA  | 2 PASS            | 50              | (52) IN TH | 148.6 | x | 107.7     | x | 2.7 | 5.85  | x | 4.24 | x | 0.108 |
| YZ105493                  | FM5929          | PAPER     | 2 PASS            | 52              | INT TH     | 170.0 | x | 107.0     | x | 2.9 | 6.69  | x | 4.21 | x | 0.114 |
| YZ105494                  | FM3813          | TAN PAPER | 2 PASS            | 50              | (52) IN TH | 148.6 | x | 107.7     | x | 2.7 | 5.85  | x | 4.24 | x | 0.108 |
| YZ106211                  | FM5932MP        | STEEL     | -----             | 69              | EXT TH     | 177.0 | x | 114.0     | x | 2.0 | 6.97  | x | 4.49 | x | 0.077 |
| YZ120964                  | FM9467          | CARBON PA | WAFFLE            | 47              | INT TH     | 291.0 | x | 146.0     | x | 3.4 | 11.46 | x | 5.74 | x | 0.134 |
| YZ121110                  | FM9476MP        | STEEL     | -----             | 8               | EXT LG     | 317.9 | x | 159.9     | x | 1.9 | 12.52 | x | 6.3  | x | 0.075 |
| YZ150185                  | FM1216MP        | STEEL     | -----             | 60              | EXT TH     | 154.2 | x | 113.8     | x | 1.8 | 6.07  | x | 4.48 | x | 0.07  |
| YZ250180                  | FM5926MP        | STEEL     | -----             | 69              | EXT TH     | 177.0 | x | 132.0     | x | 1.9 | 6.97  | x | 5.2  | x | 0.075 |
| YZ250314                  | FM5923          | PAPER     | 2 PASS            | 60              | INT TH     | 169.0 | x | 124.6     | x | 2.8 | 6.65  | x | 4.91 | x | 0.11  |
| <b>FURUKAWA (HITACHI)</b> |                 |           |                   |                 |            |       |   |           |   |     |       |   |      |   |       |
| 05003-01018               | FM2653          | BRONZE    | SUNBURST          | 76              | EXT TH     | 164.0 | x | 103.0     | x | 2.2 | 6.46  | x | 4.06 | x | 0.087 |
| 05003-01019               | FM2656MP        | STEEL     | DISHED            | 42              | INT TH     | 151.0 | x | 85.5      | x | 1.5 | 5.94  | x | 3.37 | x | 0.059 |
| 05303-05007               | FM2653          | BRONZE    | SUNBURST          | 76              | EXT TH     | 164.0 | x | 103.0     | x | 2.2 | 6.46  | x | 4.06 | x | 0.087 |

| REPLACES<br>OEM PT.NO. | FMC<br>PART NO. | MATERIAL  | GROOVE<br>DETAILS | TEETH/<br>TANGS | SIZE MM |       |   | SIZE INCH |   |     |       |   |      |   |       |
|------------------------|-----------------|-----------|-------------------|-----------------|---------|-------|---|-----------|---|-----|-------|---|------|---|-------|
| 05303-05008            | FM2656MP        | STEEL     | DISHED            | 42              | INT TH  | 151.0 | x | 85.5      | x | 1.5 | 5.94  | x | 3.37 | x | 0.059 |
| 05318-08010            | FM5947          | BRONZE    | SUNBURST          | 50              | ITN TH  | 302.0 | x | 206.0     | x | 5.0 | 11.89 | x | 8.11 | x | 0.197 |
| 05503-01065            | FM2707          | BRONZE    | WAFFLE            | 88              | EXT TH  | 189.4 | x | 141.7     | x | 3.1 | 7.46  | x | 5.58 | x | 0.122 |
| 05503-01066            | FM2710MP        | STEEL     | -----             | 52              | INT TH  | 177.8 | x | 128.2     | x | 2.3 | 7.0   | x | 5.05 | x | 0.091 |
| 05503-01129            | FM2395B         | BRONZE    | SUNBURST          | 100             | EXT TH  | 214.9 | x | 151.4     | x | 3.1 | 8.46  | x | 5.96 | x | 0.122 |
| 05503-01130            | FM2398MP        | STEEL     | DISHED            | 56              | INT TH  | 203.2 | x | 138.4     | x | 2.3 | 8.0   | x | 5.45 | x | 0.091 |
| 310211-23110           | FM3361          | PAPER     | WAFFLE            | 38              | INT TH  | 158.0 | x | 95.2      | x | 2.7 | 6.22  | x | 3.75 | x | 0.106 |
| 314211-22150           | FM3727          | PAPER     | 2 PASS            | 38              | INT TH  | 133.6 | x | 77.0      | x | 3.0 | 5.26  | x | 3.03 | x | 0.118 |
| 314211-22150           | FM2135          | PAPER     | 2 PASS            | 38              | INT TH  | 133.6 | x | 77.0      | x | 2.8 | 5.26  | x | 3.03 | x | 0.11  |
| 314211-23150           | FM3361          | PAPER     | WAFFLE            | 38              | INT TH  | 158.0 | x | 95.2      | x | 2.7 | 6.22  | x | 3.75 | x | 0.106 |
| 314351-32290           | FM1836MP        | STEEL     | -----             | 3               | INT LG  | 258.8 | x | 185.7     | x | 6.7 | 10.19 | x | 7.31 | x | 0.262 |
| 314351-32310           | FM1765          | RED PAPER | 2 PASS            | 15              | INT TH  | 259.1 | x | 51.1      | x | 7.6 | 10.2  | x | 2.01 | x | 0.3   |
| 314351-32310           | FM3807          | YELLOW PA | 2 PASS            | 15              | INT TH  | 259.1 | x | 51.1      | x | 7.6 | 10.2  | x | 2.01 | x | 0.3   |
| 332211-21150           | FM2463          | PAPER     | 2 PASS            | 38              | INT TH  | 154.7 | x | 95.0      | x | 3.7 | 6.09  | x | 3.74 | x | 0.144 |
| 335211-99120           | FM2463          | PAPER     | 2 PASS            | 38              | INT TH  | 154.7 | x | 95.0      | x | 3.7 | 6.09  | x | 3.74 | x | 0.144 |
| 337231-23250           | FM2906MP        | STEEL     | -----             | 54              | EXT TH  | 139.5 | x | 87.3      | x | 2.3 | 5.49  | x | 3.44 | x | 0.091 |
| 337231-23260           | FM2135          | PAPER     | 2 PASS            | 38              | INT TH  | 133.6 | x | 77.0      | x | 2.8 | 5.26  | x | 3.03 | x | 0.11  |
| 341221-12230           | FM5947          | BRONZE    | SUNBURST          | 50              | ITN TH  | 302.0 | x | 206.0     | x | 5.0 | 11.89 | x | 8.11 | x | 0.197 |
| 341231-21270           | FM2653          | BRONZE    | SUNBURST          | 76              | EXT TH  | 164.0 | x | 103.0     | x | 2.2 | 6.46  | x | 4.06 | x | 0.087 |
| 341231-21280           | FM2656MP        | STEEL     | DISHED            | 42              | INT TH  | 151.0 | x | 85.5      | x | 1.5 | 5.94  | x | 3.37 | x | 0.059 |
| 343231-21170           | FM2710MP        | STEEL     | -----             | 52              | INT TH  | 177.8 | x | 128.2     | x | 2.3 | 7.0   | x | 5.05 | x | 0.091 |
| 343231-21180           | FM2707          | BRONZE    | WAFFLE            | 88              | EXT TH  | 189.4 | x | 141.7     | x | 3.1 | 7.46  | x | 5.58 | x | 0.122 |
| 344211-21230           | FM2965          | BRONZE    | SUNBURST          | 68              | INT TH  | 270.0 | x | 212.0     | x | 3.9 | 10.63 | x | 8.35 | x | 0.154 |
| 344211-21240           | FM2968MP        | STEEL     | -----             | 6               | EXT LG  | 295.0 | x | 225.0     | x | 2.7 | 11.61 | x | 8.86 | x | 0.106 |
| 345211-21120           | FM4256MP        | STEEL     | -----             | 85              | EXT TH  | 181.5 | x | 116.0     | x | 1.8 | 7.15  | x | 4.57 | x | 0.071 |
| 346211-21180           | FM3239          | PAPER     | WAFFLE            | 34              | INT TH  | 167.6 | x | 105.0     | x | 2.0 | 6.6   | x | 4.13 | x | 0.08  |
| 346211-22240           | FM3239          | PAPER     | WAFFLE            | 34              | INT TH  | 167.6 | x | 105.0     | x | 2.0 | 6.6   | x | 4.13 | x | 0.08  |
| 348231-21150           | FM4199          | BRONZE    | SUNBURST          | 66              | EXT TH  | 142.6 | x | 93.5      | x | 2.2 | 5.61  | x | 3.68 | x | 0.087 |
| 348231-21160           | FM4180MP        | STEEL     | -----             | 42              | INT TH  | 132.8 | x | 85.5      | x | 1.5 | 5.23  | x | 3.37 | x | 0.059 |
| 348231-23150           | FM2653B         | BRONZE    | SUNBURST          | 76              | EXT TH  | 164.0 | x | 110.0     | x | 2.2 | 6.46  | x | 4.33 | x | 0.087 |
| 348231-23160           | FM5182MP        | STEEL     | -----             | 48              | INT TH  | 151.0 | x | 98.2      | x | 2.0 | 5.94  | x | 3.87 | x | 0.079 |
| 352211-22280           | FM1476MP        | STEEL     | -----             | 64              | EXT TH  | 164.1 | x | 107.2     | x | 1.5 | 6.46  | x | 4.22 | x | 0.06  |
| 352211-22290           | FM1477          | PAPER     | 2 PASS            | 38              | INT TH  | 157.7 | x | 95.3      | x | 2.3 | 6.21  | x | 3.75 | x | 0.09  |
| 352351-32290           | FM3439          | PAPER     | 2 PASS            | 17              | INT TH  | 277.0 | x | 62.0      | x | 7.0 | 10.91 | x | 2.44 | x | 0.276 |
| 384321-01020           | FM4190MP        | STEEL     | -----             | 21              | EXT TH  | 289.0 | x | 185.0     | x | 3.9 | 11.38 | x | 7.28 | x | 0.154 |
| 384321-01030           | FM4187          | PAPER     | 3 PASS            | 21              | INT TH  | 267.0 | x | 82.0      | x | 5.1 | 10.51 | x | 3.23 | x | 0.2   |
| A10500-20867           | FM2815          | PAPER     | 4 PASS            | 42              | INT TH  | 340.0 | x | 206.0     | x | 5.5 | 13.39 | x | 8.11 | x | 0.217 |
| A10501-32240           | FM6417          | BRONZE    | WAF/WAG           | 64              | INT TH  | 345.0 | x | 252.0     | x | 3.8 | 13.58 | x | 9.92 | x | 0.15  |
| A10502-20864           | FM2811          | PAPER     | 4 PASS            | 34              | INT TH  | 277.0 | x | 167.0     | x | 4.5 | 10.91 | x | 6.57 | x | 0.177 |
| A10502-31280           | FM4123          | BRONZE    | SUN-PLAIN         | 27              | EXT TH  | 137.4 | x | 90.9      | x | 1.6 | 5.41  | x | 3.58 | x | 0.063 |
| A10502-31283           | FM4125          | BRONZE    | SUN-PLAIN         | 35              | EXT TH  | 177.5 | x | 109.0     | x | 1.6 | 6.99  | x | 4.29 | x | 0.063 |
| A10503-30929           | FM2277          | BRONZE    | SUNBURST          | 27              | EXT TH  | 137.4 | x | 90.9      | x | 2.0 | 5.41  | x | 3.58 | x | 0.079 |
| A10503-30930           | FM2279          | BRONZE    | SUNBURST          | 35              | EXT TH  | 177.5 | x | 109.0     | x | 2.0 | 6.99  | x | 4.29 | x | 0.079 |
| A10504-20835           | FM2815          | PAPER     | 4 PASS            | 42              | INT TH  | 340.0 | x | 206.0     | x | 5.5 | 13.39 | x | 8.11 | x | 0.217 |
| A10504-20857           | FM2811          | PAPER     | 4 PASS            | 34              | INT TH  | 277.0 | x | 167.0     | x | 4.5 | 10.91 | x | 6.57 | x | 0.177 |
| A10508-20882           | FM4397          | BRONZE    | SUNBURST          | 64              | EXT TH  | 196.0 | x | 142.0     | x | 2.5 | 7.72  | x | 5.59 | x | 0.096 |
| A10508-20884           | FM4399          | BRNZ/PLN  | SUNBURST          | 64              | EXT TH  | 196.0 | x | 142.0     | x | 2.0 | 7.72  | x | 5.59 | x | 0.077 |

| REPLACES<br>OEM PT.NO. | FMC<br>PART NO. | MATERIAL | GROOVE<br>DETAILS | TEETH/<br>TANGS |           | SIZE MM |   |       | SIZE INCH |     |       |   |       |   |       |
|------------------------|-----------------|----------|-------------------|-----------------|-----------|---------|---|-------|-----------|-----|-------|---|-------|---|-------|
| A16042-31640           | FM5250-3.0      | STEEL    | HARDENED          | 4               | EXT LG    | 189.9   | x | 92.1  | x         | 3.0 | 7.47  | x | 3.63  | x | 0.118 |
| A16042-31645           | FM5250-2.7      | STEEL    | HARDENED          | 4               | EXT LG    | 189.8   | x | 92.1  | x         | 2.7 | 7.47  | x | 3.63  | x | 0.106 |
| A16042-31646           | FM5250-3.3      | STEEL    | HARDENED          | 4               | EXT LG    | 189.8   | x | 92.1  | x         | 3.3 | 7.47  | x | 3.63  | x | 0.13  |
| A24643-30830           | FM3592MP        | STEEL    | -----             | 29              | INT TH    | 131.1   | x | 85.1  | x         | 1.5 | 5.16  | x | 3.35  | x | 0.059 |
| A24643-30831           | FM3596MP        | STEEL    | -----             | 29              | INT TH    | 131.1   | x | 85.1  | x         | 2.5 | 5.16  | x | 3.35  | x | 0.098 |
|                        |                 |          |                   |                 |           |         |   |       |           |     |       |   |       |   |       |
| A24643-30832           | FM3594MP        | STEEL    | -----             | 29              | INT TH    | 131.1   | x | 85.1  | x         | 2.0 | 5.16  | x | 3.35  | x | 0.079 |
| A44643-30828           | FM3606MP        | STEEL    | -----             | 88              | (91)EX TH | 293.0   | x | 185.0 | x         | 4.0 | 11.54 | x | 7.28  | x | 0.157 |
| A44643-30829           | FM3602MP        | STEEL    | -----             | 35              | INT TH    | 170.9   | x | 102.9 | x         | 2.0 | 6.73  | x | 4.05  | x | 0.079 |
| A44643-30830           | FM3604MP        | STEEL    | -----             | 35              | INT TH    | 170.9   | x | 102.9 | x         | 2.5 | 6.73  | x | 4.05  | x | 0.098 |
| A47440-20501           | FM2811          | PAPER    | 4 PASS            | 34              | INT TH    | 277.0   | x | 167.0 | x         | 4.5 | 10.91 | x | 6.57  | x | 0.177 |
|                        |                 |          |                   |                 |           |         |   |       |           |     |       |   |       |   |       |
| A47440-30448           | FM3608MP        | STEEL    | -----             | 88              | (91)EX TH | 293.0   | x | 185.0 | x         | 4.5 | 11.54 | x | 7.28  | x | 0.177 |
| A47440-30449           | FM3606MP        | STEEL    | -----             | 88              | (91)EX TH | 293.0   | x | 185.0 | x         | 4.0 | 11.54 | x | 7.28  | x | 0.157 |
| A47440-30882           | FM3610MP        | STEEL    | -----             | 91              | EXT TH    | 355.0   | x | 217.0 | x         | 4.5 | 13.98 | x | 8.54  | x | 0.177 |
| A47440-30883           | FM3612MP        | STEEL    | -----             | 91              | EXT TH    | 355.0   | x | 217.0 | x         | 5.0 | 13.98 | x | 8.54  | x | 0.197 |
| A47440-30884           | FM3614MP        | STEEL    | -----             | 91              | EXT TH    | 355.0   | x | 217.0 | x         | 5.5 | 13.98 | x | 8.54  | x | 0.217 |
|                        |                 |          |                   |                 |           |         |   |       |           |     |       |   |       |   |       |
| A47440-30937           | FM3610MP        | STEEL    | -----             | 91              | EXT TH    | 355.0   | x | 217.0 | x         | 4.5 | 13.98 | x | 8.54  | x | 0.177 |
| A47440-30938           | FM3612MP        | STEEL    | -----             | 91              | EXT TH    | 355.0   | x | 217.0 | x         | 5.0 | 13.98 | x | 8.54  | x | 0.197 |
| A47440-30939           | FM3614MP        | STEEL    | -----             | 91              | EXT TH    | 355.0   | x | 217.0 | x         | 5.5 | 13.98 | x | 8.54  | x | 0.217 |
| A47441-35257           | FM6454MP        | STEEL    | HARDENED          | 20              | EXT LG    | 374.0   | x | 262.0 | x         | 2.4 | 14.72 | x | 10.31 | x | 0.094 |
| A47442-30502           | FM3606MP        | STEEL    | -----             | 88              | (91)EX TH | 293.0   | x | 185.0 | x         | 4.0 | 11.54 | x | 7.28  | x | 0.157 |
|                        |                 |          |                   |                 |           |         |   |       |           |     |       |   |       |   |       |
| A47442-30503           | FM3608MP        | STEEL    | -----             | 88              | (91)EX TH | 293.0   | x | 185.0 | x         | 4.5 | 11.54 | x | 7.28  | x | 0.177 |

| REPLACES<br>OEM PT.NO. | FMC<br>PART NO. | MATERIAL             | GROOVE<br>DETAILS | TEETH/<br>TANGS | SIZE MM   | SIZE INCH                                 |
|------------------------|-----------------|----------------------|-------------------|-----------------|-----------|---|
| <b>GALION</b>          |                 |                      |                   |                 |           |   |
| D72327                 | FM1324MP        | STEEL                | -----             | 54              | EXT TH    | 139.2 x 98.6 x 1.8 5.48 x 3.88 x 0.07     |
| D72330                 | FM1359          | BRONZE               | SPIRAL            | 45              | INT TH    | 133.1 x 92.7 x 1.6 5.24 x 3.65 x 0.063    |
| D72334                 | FM5452MP        | STEEL                | END PLATE         | 54              | EXT TH    | 139.2 x 98.2 x 8.7 5.48 x 3.87 x 0.343    |
| D72372                 | FM1933          | BRONZE               | RADIAL            | 59              | INT TH    | 190.8 x 147.3 x 3.0 7.51 x 5.8 x 0.118    |
| D72378                 | FM1938MP        | STEEL                | -----             | 3               | EXT LG    | 214.9 x 155.7 x 1.8 8.46 x 6.13 x 0.07    |
| D72522                 | FM5442MP        | STEEL                | END PLATE         | 54              | EXT TH    | 139.2 x 98.2 x 8.3 5.48 x 3.87 x 0.327    |
| D72757                 | FM1191          | GRAPHITE             | SUNBURST          | 60              | INT TH    | 195.1 x 145.0 x 4.0 7.68 x 5.71 x 0.156   |
| D72803                 | FM1216MP        | STEEL                | -----             | 60              | EXT TH    | 154.2 x 113.8 x 1.8 6.07 x 4.48 x 0.07    |
| D72816                 | FM1195          | BRONZE               | SUNBURST          | 60              | INT TH    | 195.1 x 145.0 x 4.0 7.68 x 5.71 x 0.156   |
| D72818                 | FM1278MP        | STEEL                | -----             | 14              | (20)EX TH | 218.9 x 158.8 x 2.7 8.62 x 6.25 x 0.106   |
| D77576                 | FM1305OE        | BRONZE               | RADIAL            | 52              | INT TH    | 148.6 x 107.7 x 2.6 5.85 x 4.24 x 0.102   |
| D79944                 | FM1816MP        | STEEL                | DISHED            | 32              | (42)EX TH | 184.2 x 92.7 x 2.6 7.25 x 3.65 x 0.102    |
| D80064                 | FM0647          | BRONZE               | SUNBURST          | 19              | INT TH    | 165.1 x 74.2 x 4.0 6.5 x 2.92 x 0.156     |
| D80065                 | FM0123          | OBSOLETE AFTER STOCK |                   | 24              | INT TH    | 187.5 x 95.3 x 4.0 7.38 x 3.75 x 0.157    |
| D80807                 | FM3215          | PAPER                | 3 PASS            | 53              | INT TH    | 368.3 x 220.5 x 5.1 14.5 x 8.68 x 0.199   |
| D80808                 | FM3218MP        | STEEL                | -----             | 89              | EXT TH    | 379.5 x 262.4 x 6.3 14.94 x 10.33 x 0.247 |
| D106118                | FM1307OE        | BRONZE               | RADIAL            | 52              | INT TH    | 148.6 x 107.7 x 2.6 5.85 x 4.24 x 0.102   |
| D139209                | FM1359          | BRONZE               | SPIRAL            | 45              | INT TH    | 133.1 x 92.7 x 1.6 5.24 x 3.65 x 0.063    |
| D139309                | FM1305OE        | BRONZE               | RADIAL            | 52              | INT TH    | 148.6 x 107.7 x 2.6 5.85 x 4.24 x 0.102   |
| 149585                 | FM1216MP        | STEEL                | -----             | 60              | EXT TH    | 154.2 x 113.8 x 1.8 6.07 x 4.48 x 0.07    |
| <b>GEHL</b>            |                 |                      |                   |                 |           |   |
| L99565                 | FM3414MP        | END PLATE            | -----             | 32              | (64)EX TH | 230.0 x 152.5 x 10.8 9.06 x 6.0 x 0.397   |
| L99566                 | FM2823          | PAPER                | 2 PASS            | 36              | INT TH    | 223.0 x 71.0 x 4.9 8.78 x 2.8 x 0.191     |
| L99567                 | FM3912MP        | END PLATE            | -----             | 64              | EXT TH    | 230.0 x 152.5 x 5.0 9.06 x 6.0 x 0.197    |
| L500643                | FM2971          | BRONZE               | WAFFLE            | 22              | INT TH    | 71.7 x 44.0 x 2.8 2.82 x 1.73 x 0.11      |
| L500644                | FM3474MP        | STEEL                | -----             | 4               | EXT LG    | 85.0 x 49.2 x 1.5 3.35 x 1.94 x 0.059     |
| L500645                | FM2969          | BRONZE               | WAFFLE            | 22              | INT TH    | 71.7 x 44.0 x 1.6 2.82 x 1.73 x 0.063     |
| <b>GENIE / TEREX</b>   |                 |                      |                   |                 |           |   |
| 501503                 | FM3474MP        | STEEL                | -----             | 4               | EXT LG    | 85.0 x 49.2 x 1.5 3.35 x 1.94 x 0.059     |
| 501504                 | FM2971          | BRONZE               | WAFFLE            | 22              | INT TH    | 71.7 x 44.0 x 2.8 2.82 x 1.73 x 0.11      |
| 501505                 | FM2969          | BRONZE               | WAFFLE            | 22              | INT TH    | 71.7 x 44.0 x 1.6 2.82 x 1.73 x 0.063     |
| 501544                 | FM2781          | GRAPHITE             | SUNBURST          | 15              | INT TH    | 213.0 x 44.0 x 10.0 8.38 x 1.73 x 0.394   |
| 502697                 | FM2777          | GRAPHITE             | SUNBURST          | 27              | INT TH    | 260.0 x 66.1 x 10.0 10.24 x 2.6 x 0.394   |
| 503069                 | FM4015          | GRAPHITE             | SUNBURST          | 27              | INT TH    | 303.8 x 66.1 x 10.0 11.96 x 2.6 x 0.393   |
| 633805                 | FM2971          | BRONZE               | WAFFLE            | 22              | INT TH    | 71.7 x 44.0 x 2.8 2.82 x 1.73 x 0.11      |
| 633806                 | FM2969          | BRONZE               | WAFFLE            | 22              | INT TH    | 71.7 x 44.0 x 1.6 2.82 x 1.73 x 0.063     |
| 633807                 | FM3474MP        | STEEL                | -----             | 4               | EXT LG    | 85.0 x 49.2 x 1.5 3.35 x 1.94 x 0.059     |
| 7-229-605              | FM4625          | PAPER                | SUNBURST          | 16              | INT TH    | 201.0 x 40.5 x 4.9 7.91 x 1.59 x 0.192    |
| 7-229-614              | FM4606MP        | STEEL                | -----             | 3               | EXT LG    | 216.9 x 144.0 x 2.7 8.54 x 5.67 x 0.106   |
| 07.0711.0004           | FM9485          | GRAPHITE             | SUNBURST          | 12              | INT TH    | 170.0 x 32.7 x 4.8 6.69 x 1.29 x 0.189    |
| 07.0711.0126           | FM2971          | BRONZE               | WAFFLE            | 22              | INT TH    | 71.7 x 44.0 x 2.8 2.82 x 1.73 x 0.11      |
| 07.0711.0127           | FM2969          | BRONZE               | WAFFLE            | 22              | INT TH    | 71.7 x 44.0 x 1.6 2.82 x 1.73 x 0.063     |
| 07.0711.0128           | FM3474MP        | STEEL                | -----             | 4               | EXT LG    | 85.0 x 49.2 x 1.5 3.35 x 1.94 x 0.059     |

| REPLACES OEM PT.NO. |          | FMC PART NO.         | MATERIAL | GROOVE DETAILS | TEETH/TANGS |       | SIZE MM |       |   | SIZE INCH |       |   |       |   |       |
|---------------------|----------|----------------------|----------|----------------|-------------|-------|---------|-------|---|-----------|-------|---|-------|---|-------|
| <b>GETMAN</b>       |          |                      |          |                |             |       |         |       |   |           |       |   |       |   |       |
| 442010              | FM1705   | BRONZE               | SPR/WAG  | 22             | INT TH      | 204.5 | x       | 53.3  | x | 4.8       | 8.05  | x | 2.1   | x | 0.19  |
| 442020              | FM1202MP | STEEL                | -----    | 1              | EXT LG      | 209.3 | x       | 114.3 | x | 2.7       | 8.24  | x | 4.5   | x | 0.106 |
| <b>GHH</b>          |          |                      |          |                |             |       |         |       |   |           |       |   |       |   |       |
| 59004-143           | FM3006MP | STEEL                | -----    | 70             | EXT TH      | 358.0 | x       | 229.0 | x | 5.0       | 14.09 | x | 9.02  | x | 0.197 |
| 59004-144           | FM4349   | PAPER                | WAFFLE   | 42             | INT TH      | 340.0 | x       | 206.0 | x | 5.5       | 13.39 | x | 8.11  | x | 0.217 |
| 59004-755           | FM4349   | PAPER                | WAFFLE   | 42             | INT TH      | 340.0 | x       | 206.0 | x | 5.5       | 13.39 | x | 8.11  | x | 0.217 |
| <b>GIRLING</b>      |          |                      |          |                |             |       |         |       |   |           |       |   |       |   |       |
| 6432 0832           | FM1591   | BRONZE               | SPR/WAG  | 22             | INT TH      | 224.0 | x       | 53.3  | x | 4.8       | 8.82  | x | 2.1   | x | 0.19  |
| 6432 1035           | FM3222MP | STEEL                | -----    | 1              | EXT LG      | 228.6 | x       | 127.0 | x | 2.7       | 9.0   | x | 5.0   | x | 0.106 |
| 6432 1506           | FM1204MP | STEEL                | -----    | 1              | EXT LG      | 228.6 | x       | 127.0 | x | 2.7       | 9.0   | x | 5.0   | x | 0.106 |
| 6432 1507           | FM1707   | BRONZE               | SPR/WAG  | 27             | INT TH      | 224.0 | x       | 55.1  | x | 4.8       | 8.82  | x | 2.17  | x | 0.19  |
| 6432 1818           | FM1711   | BRONZE               | SPR/WAG  | 23             | INT TH      | 224.0 | x       | 70.1  | x | 4.9       | 8.82  | x | 2.76  | x | 0.193 |
| 6432 1864           | FM1377   | BRONZE               | SPR/WAG  | 23             | INT TH      | 152.4 | x       | 35.6  | x | 4.8       | 6.0   | x | 1.4   | x | 0.19  |
| 6432 2030           | FM1769   | BRONZE               | SPR/WAG  | 26             | INT TH      | 178.1 | x       | 63.5  | x | 4.8       | 7.01  | x | 2.5   | x | 0.19  |
| 6432 2031           | FM1284MP | STEEL                | -----    | 1              | EXT LG      | 182.9 | x       | 82.6  | x | 2.7       | 7.2   | x | 3.25  | x | 0.106 |
| 6432 2034           | FM1713   | BRONZE               | SPR/WAG  | 12             | INT TH      | 178.1 | x       | 46.7  | x | 4.8       | 7.01  | x | 1.84  | x | 0.19  |
| 6432 2183           | FM1709   | OBSOLETE AFTER STOCK |          | 13             | INT TH      | 152.4 | x       | 38.1  | x | 4.8       | 6.0   | x | 1.5   | x | 0.19  |
| 6432 2184           | FM1340MP | OBSOLETE AFTER STOCK |          | 1              | EXT LG      | 158.8 | x       | 83.8  | x | 2.7       | 6.25  | x | 3.3   | x | 0.105 |
| 6432 2230           | FM1774MP | STEEL                | -----    | 1              | EXT LG      | 107.4 | x       | 43.9  | x | 2.6       | 4.23  | x | 1.73  | x | 0.102 |
| 6432 2287           | FM1387   | BRONZE               | SPR/WAG  | 17             | INT TH      | 224.0 | x       | 50.8  | x | 4.9       | 8.82  | x | 2.0   | x | 0.193 |
| 6432 6805           | FM1202MP | STEEL                | -----    | 1              | EXT LG      | 209.3 | x       | 114.3 | x | 2.7       | 8.24  | x | 4.5   | x | 0.106 |
| 6432 6810           | FM1591   | BRONZE               | SPR/WAG  | 22             | INT TH      | 224.0 | x       | 53.3  | x | 4.8       | 8.82  | x | 2.1   | x | 0.19  |
| 6432 6812           | FM1190MP | STEEL                | -----    | 1              | EXT LG      | 228.6 | x       | 127.0 | x | 2.6       | 9.0   | x | 5.0   | x | 0.102 |
| 6432 7556           | FM1705   | BRONZE               | SPR/WAG  | 22             | INT TH      | 204.5 | x       | 53.3  | x | 4.8       | 8.05  | x | 2.1   | x | 0.19  |
| 7332 0051           | FM1771   | BRONZE               | SPR/WAG  | 10             | INT TH      | 101.6 | x       | 29.0  | x | 4.8       | 4.0   | x | 1.14  | x | 0.19  |
| 7332 0118           | FM1769   | BRONZE               | SPR/WAG  | 26             | INT TH      | 178.1 | x       | 63.5  | x | 4.8       | 7.01  | x | 2.5   | x | 0.19  |
| 7332 0178           | FM2023   | BRONZE               | SPR/WAG  | 23             | INT TH      | 177.8 | x       | 43.9  | x | 4.8       | 7.0   | x | 1.73  | x | 0.19  |
| 7332 0201           | FM2372MP | STEEL                | -----    | 1              | EXT LG      | 228.6 | x       | 146.1 | x | 2.6       | 9.0   | x | 5.75  | x | 0.102 |
| 7332 0204           | FM3038MP | STEEL                | -----    | 1              | EXT SL      | 236.0 | x       | 85.0  | x | 2.7       | 9.29  | x | 3.35  | x | 0.106 |
| 7332 0209           | FM3035   | PAPER                | WAFFLE   | 22             | INT TH      | 204.5 | x       | 53.3  | x | 4.8       | 8.05  | x | 2.1   | x | 0.189 |
| 7332 0222           | TBA      | PAPER                | 2 PASS   | 36             | INT TH      | 224.0 | x       | 53.3  | x | 4.8       | 8.82  | x | 2.1   | x | 0.189 |
| 7332 0284           | FM3038MP | STEEL                | -----    | 1              | EXT SL      | 236.0 | x       | 85.0  | x | 2.7       | 9.29  | x | 3.35  | x | 0.106 |
| 7332 0298           | FM2217   | BRONZE               | SPR/WAG  | 22             | INT TH      | 224.0 | x       | 53.3  | x | 4.8       | 8.82  | x | 2.1   | x | 0.19  |
| 7332 0320           | FM3320   | BRONZE               | SPR/WAG  | 50             | INT TH      | 224.0 | x       | 62.5  | x | 4.8       | 8.82  | x | 2.46  | x | 0.189 |
| 7332 0440           | FM2215   | BRONZE               | SPR/WAG  | 22             | INT TH      | 204.5 | x       | 53.3  | x | 4.8       | 8.05  | x | 2.1   | x | 0.19  |
| 7332 0603           | FM8563   | CARBON PA            | WAFFLE   | 27             | INT TH      | 223.5 | x       | 54.9  | x | 4.8       | 8.8   | x | 2.16  | x | 0.189 |
| 7332 0666           | FM2217   | BRONZE               | SPR/WAG  | 22             | INT TH      | 224.0 | x       | 53.3  | x | 4.8       | 8.82  | x | 2.1   | x | 0.19  |
| 7332 0676           | FM1591   | BRONZE               | SPR/WAG  | 22             | INT TH      | 224.0 | x       | 53.3  | x | 4.8       | 8.82  | x | 2.1   | x | 0.19  |
| <b>GLEISBAU</b>     |          |                      |          |                |             |       |         |       |   |           |       |   |       |   |       |
| 560846              | FM3801   | PAPER                | RADIAL   | 30             | INT LG      | 329.0 | x       | 285.0 | x | 3.0       | 12.96 | x | 11.24 | x | 0.117 |

| REPLACES<br>OEM PT.NO.  | FMC<br>PART NO. | MATERIAL  | GROOVE<br>DETAILS | TEETH/<br>TANGS | SIZE MM   | SIZE INCH                                |
|-------------------------|-----------------|-----------|-------------------|-----------------|-----------|--|
| <b>GM DIESEL MARINE</b> |                 |           |                   |                 |           |  |
| 6835329                 | OBSOLETE        | GRAPHITE  | SUNBURST          | 16              | INT TH    | 400.1 x 214.9 x 5.4 15.75 x 8.46 x 0.213 |
| 23010125                | OBSOLETE        | GRAPHITE  | SUNBURST          | 16              | INT TH    | 400.1 x 214.9 x 5.4 15.75 x 8.46 x 0.213 |
| <b>GRADALL</b>          |                 |           |                   |                 |           |  |
| 0420-0333               | FM3650MP        | STEEL     | -----             | 54              | EXT TH    | 139.2 x 98.6 x 3.0 5.48 x 3.88 x 0.118   |
| 0420-0341               | FM2829          | PAPER     | 2 PASS            | 45              | INT TH    | 133.1 x 92.7 x 2.1 5.24 x 3.65 x 0.083   |
| 9147-4141               | FM3912MP        | END PLATE | -----             | 64              | EXT TH    | 230.0 x 152.5 x 5.0 9.06 x 6.0 x 0.197   |
| <b>GRAZIANO</b>         |                 |           |                   |                 |           |  |
| 3128113                 | FM1927          | GRAPHITE  | SUNBURST          | 44              | INT TH    | 162.1 x 104.9 x 2.4 6.38 x 4.13 x 0.094  |
| 3138883                 | FM3615          | PAPER     | WAFFLE            | 45              | INT TH    | 133.1 x 92.7 x 2.4 5.24 x 3.65 x 0.096   |
| 3138933                 | FM1958MP        | STEEL     | -----             | 54              | EXT TH    | 139.2 x 98.6 x 2.3 5.48 x 3.88 x 0.09    |
| 3143503                 | FM1930MP        | STEEL     | -----             | 72              | EXT TH    | 175.0 x 118.1 x 1.5 6.89 x 4.65 x 0.059  |
| 3146363                 | FM2997          | PAPER     | 2 PASS            | 72              | INT TH    | 298.0 x 215.0 x 4.5 11.73 x 8.46 x 0.177 |
| 3146743                 | FM2995          | PAPER     | 2 PASS            | 54              | INT TH    | 325.0 x 224.0 x 4.5 12.8 x 8.82 x 0.177  |
| 3146763                 | FM2991          | PAPER     | 3 PASS            | 57              | INT TH    | 360.0 x 237.0 x 4.5 14.17 x 9.33 x 0.177 |
| 3146793                 | FM3640MP        | STEEL     | -----             | 75              | EXT TH    | 315.0 x 226.0 x 3.9 12.4 x 8.9 x 0.154   |
| 3146803                 | FM3644MP        | STEEL     | -----             | 75              | EXT TH    | 315.0 x 226.0 x 4.5 12.4 x 8.9 x 0.177   |
| 3146813                 | FM3646MP        | STEEL     | -----             | 75              | EXT TH    | 315.0 x 226.0 x 5.0 12.4 x 8.9 x 0.197   |
| 3146823                 | FM3630MP        | STEEL     | -----             | 75              | EXT TH    | 345.0 x 243.0 x 3.9 13.58 x 9.57 x 0.154 |
| 3146833                 | FM3634MP        | STEEL     | -----             | 75              | EXT TH    | 345.0 x 243.0 x 4.5 13.58 x 9.57 x 0.177 |
| 3146843                 | FM3636MP        | STEEL     | -----             | 75              | EXT TH    | 345.0 x 243.0 x 5.0 13.58 x 9.57 x 0.197 |
| 3146853                 | FM3620MP        | STEEL     | -----             | 75              | EXT TH    | 383.0 x 253.0 x 3.9 15.08 x 9.96 x 0.154 |
| 3146863                 | FM3624MP        | STEEL     | -----             | 75              | EXT TH    | 383.0 x 253.0 x 4.5 15.08 x 9.96 x 0.177 |
| 3146873                 | FM3626MP        | STEEL     | -----             | 75              | EXT TH    | 383.0 x 253.0 x 5.0 15.08 x 9.96 x 0.197 |
| 3148073                 | FM4119          | GRAPHITE  | SUNBURST          | 14              | INT TH    | 304.0 x 57.0 x 10.0 11.97 x 2.24 x 0.394 |
| 3154543                 | FM3642MP        | STEEL     | -----             | 75              | EXT TH    | 315.0 x 226.0 x 4.3 12.4 x 8.9 x 0.167   |
| 3200513                 | FM3632MP        | STEEL     | -----             | 75              | EXT TH    | 345.0 x 243.0 x 4.2 13.58 x 9.57 x 0.165 |
| 3200523                 | FM3622MP        | STEEL     | -----             | 75              | EXT TH    | 383.0 x 253.0 x 4.3 15.08 x 9.96 x 0.167 |
| 3243223                 | FM2995          | PAPER     | 2 PASS            | 54              | INT TH    | 325.0 x 224.0 x 4.5 12.8 x 8.82 x 0.177  |
| 3243233                 | FM2991          | PAPER     | 3 PASS            | 57              | INT TH    | 360.0 x 237.0 x 4.5 14.17 x 9.33 x 0.177 |
| 3279433                 | FM2991          | PAPER     | 3 PASS            | 57              | INT TH    | 360.0 x 237.0 x 4.5 14.17 x 9.33 x 0.177 |
| 3279443                 | FM2995          | PAPER     | 2 PASS            | 54              | INT TH    | 325.0 x 224.0 x 4.5 12.8 x 8.82 x 0.177  |
| 3299593                 | FM2991          | PAPER     | 3 PASS            | 57              | INT TH    | 360.0 x 237.0 x 4.5 14.17 x 9.33 x 0.177 |
| 3794333                 | FM2995          | PAPER     | 2 PASS            | 54              | INT TH    | 325.0 x 224.0 x 4.5 12.8 x 8.82 x 0.177  |
| <b>GROVE</b>            |                 |           |                   |                 |           |  |
| 1679956                 | FM6028MP        | OBSOLETE  | -----             | 24              | INT TH    | 122.0 x 92.0 x 1.5 4.8 x 3.62 x 0.059    |
| 2217990                 | FM6025          | OBSOLETE  | SPR/RAD           | 32              | EXT TH    | 133.0 x 101.0 x 2.4 5.24 x 3.98 x 0.094  |
| 2313168                 | FM6025          | OBSOLETE  | SPR/RAD           | 32              | EXT TH    | 133.0 x 101.0 x 2.4 5.24 x 3.98 x 0.094  |
| 8392257                 | FM3602MP        | STEEL     | -----             | 35              | INT TH    | 170.9 x 102.9 x 2.0 6.73 x 4.05 x 0.079  |
| 22517789                | FM2279          | BRONZE    | SUNBURST          | 35              | EXT TH    | 177.5 x 109.0 x 2.0 6.99 x 4.29 x 0.079  |
| 9904100634              | FM1276MP        | STEEL     | DISHED            | 50              | (54)EX TH | 138.9 x 98.0 x 1.8 5.47 x 3.86 x 0.07    |
| 9904101482              | FM1938MP        | STEEL     | -----             | 3               | EXT LG    | 214.9 x 155.7 x 1.8 8.46 x 6.13 x 0.07   |
| 9904101483              | FM1933          | BRONZE    | RADIAL            | 59              | INT TH    | 190.8 x 147.3 x 3.0 7.51 x 5.8 x 0.118   |
| 9904101520              | FM1276MP        | STEEL     | DISHED            | 50              | (54)EX TH | 138.9 x 98.0 x 1.8 5.47 x 3.86 x 0.07    |



| REPLACES<br>OEM PT.NO. | FMC<br>PART NO. | MATERIAL | GROOVE<br>DETAILS | TEETH/<br>TANGS | SIZE MM |       |   | SIZE INCH |   |     |       |   |       |   |       |
|------------------------|-----------------|----------|-------------------|-----------------|---------|-------|---|-----------|---|-----|-------|---|-------|---|-------|
| 9904101523             | FM1359          | BRONZE   | SPIRAL            | 45              | INT TH  | 133.1 | x | 92.7      | x | 1.6 | 5.24  | x | 3.65  | x | 0.063 |
| 9904101524             | FM5452MP        | STEEL    | END PLATE         | 54              | EXT TH  | 139.2 | x | 98.2      | x | 8.7 | 5.48  | x | 3.87  | x | 0.343 |
| 9904105540             | FM5442MP        | STEEL    | END PLATE         | 54              | EXT TH  | 139.2 | x | 98.2      | x | 8.3 | 5.48  | x | 3.87  | x | 0.327 |
| 9904105541             | FM1649          | PAPER    | 2 PASS            | 45              | INT TH  | 133.1 | x | 92.7      | x | 1.6 | 5.24  | x | 3.65  | x | 0.063 |
| 9904106470             | FM2787          | GRAPHITE | SUNBURST          | 52              | INT TH  | 175.3 | x | 106.7     | x | 2.9 | 6.9   | x | 4.2   | x | 0.114 |
| 9904106471             | FM2738MP        | STEEL    | -----             | 71              | EXT TH  | 182.6 | x | 117.9     | x | 1.8 | 7.19  | x | 4.64  | x | 0.069 |
| 9904109925             | FM3801          | PAPER    | RADIAL            | 30              | INT LG  | 329.0 | x | 285.0     | x | 3.0 | 12.96 | x | 11.24 | x | 0.117 |
| 9904109932             | FM2277          | BRONZE   | SUNBURST          | 27              | EXT TH  | 137.4 | x | 90.9      | x | 2.0 | 5.41  | x | 3.58  | x | 0.079 |

| REPLACES<br>OEM PT.NO.   | FMC<br>PART NO. | MATERIAL             | GROOVE<br>DETAILS | TEETH/<br>TANGS | SIZE MM   |       |   |       | SIZE INCH |     |       |   |      |   |       |
|--------------------------|-----------------|----------------------|-------------------|-----------------|-----------|-------|---|-------|-----------|-----|-------|---|------|---|-------|
| <b>HALLA</b>             |                 |                      |                   |                 |           |       |   |       |           |     |       |   |      |   |       |
| FAC0300040               | FM2063          | PAPER                | WAFFLE            | 41              | INT TH    | 125.0 | x | 68.6  | x         | 2.9 | 4.92  | x | 2.7  | x | 0.114 |
| FAC0300050               | FM2440MP        | STEEL                | -----             | 4               | EXT LG    | 137.8 | x | 80.0  | x         | 3.2 | 5.42  | x | 3.15 | x | 0.125 |
| FAD0300500               | FM2721          | BRONZE               | SUNBURST          | 47              | INT TH    | 147.0 | x | 90.5  | x         | 3.0 | 5.79  | x | 3.56 | x | 0.118 |
| FAD0300600               | FM2724MP        | STEEL                | -----             | 8               | EXT LG    | 157.0 | x | 100.0 | x         | 1.4 | 6.18  | x | 3.94 | x | 0.055 |
| 3146823                  | FM3630MP        | STEEL                | -----             | 75              | EXT TH    | 345.0 | x | 243.0 | x         | 3.9 | 13.58 | x | 9.57 | x | 0.154 |
| 3146853                  | FM3620MP        | STEEL                | -----             | 75              | EXT TH    | 383.0 | x | 253.0 | x         | 3.9 | 15.08 | x | 9.96 | x | 0.154 |
| 3243223                  | FM2995          | PAPER                | 2 PASS            | 54              | INT TH    | 325.0 | x | 224.0 | x         | 4.5 | 12.8  | x | 8.82 | x | 0.177 |
| 3243233                  | FM2991          | PAPER                | 3 PASS            | 57              | INT TH    | 360.0 | x | 237.0 | x         | 4.5 | 14.17 | x | 9.33 | x | 0.177 |
| <b>HAMWORTHY</b>         |                 |                      |                   |                 |           |       |   |       |           |     |       |   |      |   |       |
| 630.192.041              | FM1389          | BRONZE               | SPIRAL            | 57              | INT TH    | 128.3 | x | 87.9  | x         | 2.5 | 5.05  | x | 3.46 | x | 0.098 |
| 630.192.033              | FM1302MP        | STEEL                | -----             | 64              | EXT TH    | 137.2 | x | 96.3  | x         | 1.5 | 5.4   | x | 3.79 | x | 0.059 |
| 630.192.066              | FM4418MP        | STEEL                | -----             | 40              | (52)EX TH | 170.9 | x | 134.7 | x         | 1.4 | 6.73  | x | 5.3  | x | 0.055 |
| 660.020.039              | FM1591          | BRONZE               | SPR/WAG           | 22              | INT TH    | 224.0 | x | 53.3  | x         | 4.8 | 8.82  | x | 2.1  | x | 0.19  |
| 660.020.054              | FM1204MP        | STEEL                | -----             | 1               | EXT LG    | 228.6 | x | 127.0 | x         | 2.7 | 9.0   | x | 5.0  | x | 0.106 |
| 660.020.138              | FM1284MP        | STEEL                | -----             | 1               | EXT LG    | 182.9 | x | 82.6  | x         | 2.7 | 7.2   | x | 3.25 | x | 0.106 |
| 660.020.146              | FM1713          | BRONZE               | SPR/WAG           | 12              | INT TH    | 178.1 | x | 46.7  | x         | 4.8 | 7.01  | x | 1.84 | x | 0.19  |
| 660.020.468              | FM1769          | BRONZE               | SPR/WAG           | 26              | INT TH    | 178.1 | x | 63.5  | x         | 4.8 | 7.01  | x | 2.5  | x | 0.19  |
| 660.020.476              | FM1711          | BRONZE               | SPR/WAG           | 23              | INT TH    | 224.0 | x | 70.1  | x         | 4.9 | 8.82  | x | 2.76 | x | 0.193 |
| 660.020.492              | FM1340MP        | OBSOLETE AFTER STOCK |                   | 1               | EXT LG    | 158.8 | x | 83.8  | x         | 2.7 | 6.25  | x | 3.3  | x | 0.105 |
| 660.020.500              | FM1709          | OBSOLETE AFTER STOCK |                   | 13              | INT TH    | 152.4 | x | 38.1  | x         | 4.8 | 6.0   | x | 1.5  | x | 0.19  |
| 660.020.773              | FM1774MP        | STEEL                | -----             | 1               | EXT LG    | 107.4 | x | 43.9  | x         | 2.6 | 4.23  | x | 1.73 | x | 0.102 |
| 660.021.177              | FM1771          | BRONZE               | SPR/WAG           | 10              | INT TH    | 101.6 | x | 29.0  | x         | 4.8 | 4     | x | 1.14 | x | 0.19  |
| 660.090.156              | FM4425          | BRONZE               | WAFFLE            | 6               | EXT LG    | 125.5 | x | 89.8  | x         | 2.0 | 4.94  | x | 3.54 | x | 0.079 |
| 660.090.164              | FM5506MP        | STEEL                | -----             | 27              | INT TH    | 114.3 | x | 66.1  | x         | 1.2 | 4.5   | x | 2.6  | x | 0.047 |
| 660.090.529              | FM4418MP        | STEEL                | -----             | 40              | (52)EX TH | 170.9 | x | 134.7 | x         | 1.4 | 6.73  | x | 5.3  | x | 0.055 |
| 660.090.537              | FM0541          | BRONZE               | SUNBURST          | 38              | INT TH    | 162.6 | x | 120.9 | x         | 2.3 | 6.4   | x | 4.76 | x | 0.09  |
| 660.090.545              | FM4792MP        | STEEL                | -----             | 3               | EXT LG    | 99.1  | x | 68.0  | x         | 1.4 | 3.9   | x | 2.68 | x | 0.055 |
| 660.090.610              | FM4639          | PAPER                | 2 PASS            | 57              | INT TH    | 128.3 | x | 87.9  | x         | 2.4 | 5.05  | x | 3.46 | x | 0.094 |
| <b>HANOMAG (KOMATSU)</b> |                 |                      |                   |                 |           |       |   |       |           |     |       |   |      |   |       |
| 769 721 73               | FM6057          | OBSOLETE             | WAFFLE            | 95              | EXT TH    | 287.0 | x | 189.0 | x         | 4.0 | 11.3  | x | 7.44 | x | 0.157 |
| 792 250 73               | FM6060MP        | OBSOLETE             | SINAWAVED         | 60              | INT TH    | 270.0 | x | 175.0 | x         | 3.0 | 10.63 | x | 6.89 | x | 0.118 |
| 246 912 669              | FM4437          | BRONZE               | SPR/RAD           | 8               | EXT LG    | 177.0 | x | 118.0 | x         | 2.4 | 6.97  | x | 4.65 | x | 0.094 |
| 340 912 110              | FM4437          | BRONZE               | SPR/RAD           | 8               | EXT LG    | 177.0 | x | 118.0 | x         | 2.4 | 6.97  | x | 4.65 | x | 0.094 |
| 371 912 151              | FM5456MP        | STEEL                | -----             | 45              | INT TH    | 190.0 | x | 132.0 | x         | 1.6 | 7.48  | x | 5.2  | x | 0.063 |
| 371 912 152              | FM5453          | BRONZE               | SPR/RAD           | 10              | EXT TH    | 205.0 | x | 142.0 | x         | 2.4 | 8.07  | x | 5.59 | x | 0.094 |
| 374 913 220              | FM2679          | BRONZE               | SPR/RAD           | 62              | EXT TH    | 188.0 | x | 132.0 | x         | 2.4 | 7.4   | x | 5.2  | x | 0.094 |
| 374 913 230              | FM2682MP        | STEEL                | -----             | 41              | INT TH    | 178.0 | x | 119.0 | x         | 2.3 | 7.01  | x | 4.69 | x | 0.091 |
| 375 914 358              | FM4519          | OBSOLETE             | RAD/2 PASS        | 58              | INT TH    | 317.0 | x | 232.0 | x         | 5.0 | 12.48 | x | 9.13 | x | 0.197 |
| 375 914 511              | FM6622MP        | STEEL                | -----             | 12              | EXT SL    | 339.4 | x | 244.1 | x         | 2.6 | 13.36 | x | 9.61 | x | 0.102 |
| 2886965M1                | FM4437          | BRONZE               | SPR/RAD           | 8               | EXT LG    | 177.0 | x | 118.0 | x         | 2.4 | 6.97  | x | 4.65 | x | 0.094 |
| 2889516M1                | FM5456MP        | STEEL                | -----             | 45              | INT TH    | 190.0 | x | 132.0 | x         | 1.6 | 7.48  | x | 5.2  | x | 0.063 |
| 2889517M1                | FM5453          | BRONZE               | SPR/RAD           | 10              | EXT TH    | 205.0 | x | 142.0 | x         | 2.4 | 8.07  | x | 5.59 | x | 0.094 |
| 2895203M1                | FM2679          | BRONZE               | SPR/RAD           | 62              | EXT TH    | 188.0 | x | 132.0 | x         | 2.4 | 7.4   | x | 5.2  | x | 0.094 |
| 2895205M1                | FM2682MP        | STEEL                | -----             | 41              | INT TH    | 178.0 | x | 119.0 | x         | 2.3 | 7.01  | x | 4.69 | x | 0.091 |

| REPLACES<br>OEM PT.NO. | FMC<br>PART NO. | MATERIAL   | GROOVE<br>DETAILS | TEETH/<br>TANGS | SIZE MM   |       |   | SIZE INCH |   |     |       |   |       |   |       |
|------------------------|-----------------|------------|-------------------|-----------------|-----------|-------|---|-----------|---|-----|-------|---|-------|---|-------|
| 2898254M1              | FM4519          | OBSOLETE   | RAD/2 PASS        | 58              | INT TH    | 317.0 | x | 232.0     | x | 5.0 | 12.48 | x | 9.13  | x | 0.197 |
| 2898387M1              | FM6622MP        | STEEL      | -----             | 12              | EXT SL    | 339.4 | x | 244.1     | x | 2.6 | 13.36 | x | 9.61  | x | 0.102 |
| 2945140M1              | FM3021          | BRONZE     | SUNBURST          | 87              | INT TH    | 306.0 | x | 258.0     | x | 3.0 | 12.05 | x | 10.16 | x | 0.118 |
| 2945141M1              | FM3024MP        | STEEL      | -----             | 12              | EXT LG    | 317.7 | x | 268.0     | x | 3.0 | 12.51 | x | 10.55 | x | 0.118 |
| 3075406M1              | FM2962MP        | STEEL      | -----             | 37              | INT TH    | 204.6 | x | 143.8     | x | 2.0 | 8.06  | x | 5.66  | x | 0.079 |
| 3075407M1              | FM2943          | BRONZE     | SPR/RAD           | 42              | EXT TH    | 212.5 | x | 154.5     | x | 2.5 | 8.37  | x | 6.08  | x | 0.098 |
| 3231074M1              | FM4449          | MOLYBDENUM | SPR/WAG           | 26              | INT TH    | 147.8 | x | 75.4      | x | 3.0 | 5.82  | x | 2.97  | x | 0.118 |
| 3232248M1              | FM4666-2.2      | STEEL      | HARDENED          | 6               | EXT SL    | 130.0 | x | 66.8      | x | 2.2 | 5.12  | x | 2.63  | x | 0.087 |
| 3232249M1              | FM4451          | MOLYBDENUM | SPR/WAG           | 46              | (50)IN TH | 117.5 | x | 62.6      | x | 2.6 | 4.63  | x | 2.46  | x | 0.102 |
| 3232316M1              | FM3606MP        | STEEL      | -----             | 88              | (91)EX TH | 293.0 | x | 185.0     | x | 4.0 | 11.54 | x | 7.28  | x | 0.157 |
| 3232317M1              | FM2811          | PAPER      | 4 PASS            | 34              | INT TH    | 277.0 | x | 167.0     | x | 4.5 | 10.91 | x | 6.57  | x | 0.177 |
| 3235022M1              | FM3024MP        | STEEL      | -----             | 12              | EXT LG    | 317.7 | x | 268.0     | x | 3.0 | 12.51 | x | 10.55 | x | 0.118 |
| 3235530M1              | FM3612MP        | STEEL      | -----             | 91              | EXT TH    | 355.0 | x | 217.0     | x | 5.0 | 13.98 | x | 8.54  | x | 0.197 |
| 3235531M1              | FM2815          | PAPER      | 4 PASS            | 42              | INT TH    | 340.0 | x | 206.0     | x | 5.5 | 13.39 | x | 8.11  | x | 0.217 |
| 4401009M1              | FM4845          | BRONZE     | SPR/RAD           | 6               | EXT LG    | 157.0 | x | 102.0     | x | 2.4 | 6.18  | x | 4.02  | x | 0.094 |
| 4906371M1              | FM4650MP        | STEEL      | -----             | 24              | EXT TH    | 108.2 | x | 76.2      | x | 1.2 | 4.26  | x | 3.0   | x | 0.045 |
| 4906373M1              | FM4647          | BRONZE     | SPR/RAD           | 34              | INT TH    | 100.0 | x | 68.2      | x | 1.6 | 3.94  | x | 2.69  | x | 0.061 |
| 4907987M1              | FM2811          | PAPER      | 4 PASS            | 34              | INT TH    | 277.0 | x | 167.0     | x | 4.5 | 10.91 | x | 6.57  | x | 0.177 |
| 4909585M1              | FM3610MP        | STEEL      | -----             | 91              | EXT TH    | 355.0 | x | 217.0     | x | 4.5 | 13.98 | x | 8.54  | x | 0.177 |
| 4914833M1              | FM3606MP        | STEEL      | -----             | 88              | (91)EX TH | 293.0 | x | 185.0     | x | 4.0 | 11.54 | x | 7.28  | x | 0.157 |
| 4914834M1              | FM3608MP        | STEEL      | -----             | 88              | (91)EX TH | 293.0 | x | 185.0     | x | 4.5 | 11.54 | x | 7.28  | x | 0.177 |
| 4917909M1              | FM2815          | PAPER      | 4 PASS            | 42              | INT TH    | 340.0 | x | 206.0     | x | 5.5 | 13.39 | x | 8.11  | x | 0.217 |
| 4918798M1              | FM2811          | PAPER      | 4 PASS            | 34              | INT TH    | 277.0 | x | 167.0     | x | 4.5 | 10.91 | x | 6.57  | x | 0.177 |
| 4919480M1              | FM5247          | MOLYBDENUM | SPR/WAG           | 40              | INT TH    | 172.0 | x | 84.1      | x | 3.0 | 6.77  | x | 3.31  | x | 0.118 |
| 4919529M1              | FM3608MP        | STEEL      | -----             | 88              | (91)EX TH | 293.0 | x | 185.0     | x | 4.5 | 11.54 | x | 7.28  | x | 0.177 |
| 4919530M1              | FM3606MP        | STEEL      | -----             | 88              | (91)EX TH | 293.0 | x | 185.0     | x | 4.0 | 11.54 | x | 7.28  | x | 0.157 |
| 4919631M1              | FM3612MP        | STEEL      | -----             | 91              | EXT TH    | 355.0 | x | 217.0     | x | 5.0 | 13.98 | x | 8.54  | x | 0.197 |
| 4919632M1              | FM3610MP        | STEEL      | -----             | 91              | EXT TH    | 355.0 | x | 217.0     | x | 4.5 | 13.98 | x | 8.54  | x | 0.177 |
| 4919633M1              | FM3614MP        | STEEL      | -----             | 91              | EXT TH    | 355.0 | x | 217.0     | x | 5.5 | 13.98 | x | 8.54  | x | 0.217 |
| 4919643M1              | FM4451          | MOLYBDENUM | SPR/WAG           | 46              | (50)IN TH | 117.5 | x | 62.6      | x | 2.6 | 4.63  | x | 2.46  | x | 0.102 |
| <b>HARRISON</b>        |                 |            |                   |                 |           |       |   |           |   |     |       |   |       |   |       |
| 103267A                | FM1359          | BRONZE     | SPIRAL            | 45              | INT TH    | 133.1 | x | 92.7      | x | 1.6 | 5.24  | x | 3.65  | x | 0.063 |
| 103268A                | FM1276MP        | STEEL      | DISHED            | 50              | (54)EX TH | 138.9 | x | 98.0      | x | 1.8 | 5.47  | x | 3.86  | x | 0.07  |
| <b>HATRA</b>           |                 |            |                   |                 |           |       |   |           |   |     |       |   |       |   |       |
| 4290001                | FM3417          | BRONZE     | SPR/RAD           | 78              | EXT TH    | 236.0 | x | 155.0     | x | 4.0 | 9.29  | x | 6.1   | x | 0.157 |
| 4290002                | FM3933          | BRONZE     | SPR/RAD           | 6               | EXT LG    | 137.0 | x | 84.0      | x | 2.4 | 5.39  | x | 3.31  | x | 0.094 |
| 4290010                | FM3017          | BRONZE     | SUNBURST          | 68              | EXT TH    | 208.0 | x | 145.0     | x | 3.5 | 8.19  | x | 5.71  | x | 0.138 |
| 4290011                | FM3173          | BRONZE     | SPR/RAD           | 6               | EXT LG    | 177.0 | x | 118.0     | x | 2.4 | 6.97  | x | 4.65  | x | 0.094 |
| 4290012                | FM2679          | BRONZE     | SPR/RAD           | 62              | EXT TH    | 188.0 | x | 132.0     | x | 2.4 | 7.4   | x | 5.2   | x | 0.094 |
| 4290030                | FM4845          | BRONZE     | SPR/RAD           | 6               | EXT LG    | 157.0 | x | 102.0     | x | 2.4 | 6.18  | x | 4.02  | x | 0.094 |
| 4290031                | FM3935          | BRONZE     | SPR/RAD           | 6               | EXT LG    | 122.0 | x | 72.0      | x | 2.4 | 4.8   | x | 2.83  | x | 0.094 |
| 4290100                | FM4332MP        | STEEL      | -----             | 48              | INT TH    | 225.0 | x | 140.0     | x | 3.0 | 8.86  | x | 5.51  | x | 0.118 |
| 4290102                | FM4848MP        | STEEL      | SINEWAVED         | 3               | INT TH    | 123.0 | x | 72.2      | x | 1.5 | 4.84  | x | 2.84  | x | 0.059 |
| 4290107                | FM2682MP        | STEEL      | -----             | 41              | INT TH    | 178.0 | x | 119.0     | x | 2.3 | 7.01  | x | 4.69  | x | 0.091 |
| 4290111                | FM2678MP        | STEEL      | -----             | 44              | INT TH    | 162.0 | x | 105.0     | x | 2.3 | 6.38  | x | 4.13  | x | 0.091 |

| REPLACES<br>OEM PT.NO.                | FMC<br>PART NO. | MATERIAL  | GROOVE<br>DETAILS | TEETH/<br>TANGS | SIZE MM   | SIZE INCH                                 |
|---------------------------------------|-----------------|-----------|-------------------|-----------------|-----------|---|
| <b>HAULOTTE</b>                       |                 |           |                   |                 |           |   |
| 2326003140                            | FM3912MP        | END PLATE | -----             | 64              | EXT TH    | 230.0 x 152.5 x 5.0 9.06 x 6.0 x 0.197    |
| 2326003150                            | FM3414MP        | END PLATE | -----             | 32              | (64)EX TH | 230.0 x 152.5 x 10.8 9.06 x 6.0 x 0.397   |
| 2326003160                            | FM2823          | PAPER     | 2 PASS            | 36              | INT TH    | 223.0 x 71.0 x 4.9 8.78 x 2.8 x 0.191     |
| <b>HINDUSTAN MOTORS (CATERPILLAR)</b> |                 |           |                   |                 |           |   |
| 81018203                              | FM5547          | PAPER     | 3 PASS            | 62              | INT TH    | 467.1 x 308.1 x 5.0 18.39 x 12.13 x 0.197 |
| 81018204                              | FM5550MP        | STEEL     | -----             | 95              | EXT TH    | 494.0 x 328.7 x 2.5 19.45 x 12.94 x 0.096 |
| 81018205                              | FM5551          | CORK      | -----             | 95              | EXT TH    | 494.0 x 328.7 x 6.9 19.45 x 12.94 x 0.27  |
| <b>HITACHI</b>                        |                 |           |                   |                 |           |   |
| 308633                                | FM1825          | PAPER     | 2 PASS            | 54              | INT TH    | 215.0 x 168.4 x 2.9 8.46 x 6.63 x 0.116   |
| 311323                                | FM6488MP        | STEEL     | -----             | 4               | EXT LG    | 169.5 x 138.0 x 3.0 6.67 x 5.43 x 0.118   |
| 311324                                | FM6485          | PAPER     | 2 PASS            | 28              | (33)IN TH | 155.5 x 128.3 x 3.6 6.12 x 5.05 x 0.14    |
| 313215                                | FM9148MP        | STEEL     | -----             | 105             | EXT TH    | 223.7 x 178.0 x 1.5 8.81 x 7.0 x 0.059    |
| 365332                                | FM3395          | ELASTOMER | RADIAL            | 56              | (60)IN TH | 180.0 x 145.0 x 4.0 7.09 x 5.71 x 0.157   |
| 365333                                | FM3398MP        | STEEL     | -----             | 12              | EXT LG    | 188.5 x 158.0 x 1.5 7.42 x 6.22 x 0.059   |
| 365428                                | FM3409P         | PAPER     | 2 PASS            | 60              | (64)IN TH | 190.0 x 156.0 x 4.2 7.48 x 6.14 x 0.165   |
| 365429                                | FM3412MP        | STEEL     | -----             | 12              | EXT LG    | 199.5 x 169.0 x 1.5 7.85 x 6.65 x 0.059   |
| 444211                                | FM4433          | PAPER     | 2 PASS            | 28              | (34)IN TH | 127.0 x 102.0 x 2.6 5 x 4.02 x 0.104      |
| 444212                                | FM4436MP        | STEEL     | -----             | 4               | EXT LG    | 141.0 x 112.0 x 1.5 5.55 x 4.41 x 0.059   |
| 667620                                | FM3231          | PAPER     | WAFFLE            | 38              | (45)IN TH | 166.0 x 136.0 x 1.8 6.54 x 5.35 x 0.07    |
| 667621                                | FM3234MP        | STEEL     | -----             | 12              | EXT LG    | 175.0 x 146.0 x 1.4 6.89 x 5.75 x 0.053   |
| 788816                                | FM7093          | PAPER     | 2 PASS            | 43              | INT TH    | 155.0 x 129.4 x 2.0 6.1 x 5.09 x 0.079    |
| 788817                                | FM7096MP        | STEEL     | -----             | 8               | EXT LG    | 163.7 x 139.0 x 1.7 6.44 x 5.47 x 0.067   |
| 884531                                | FM4844MP        | STEEL     | -----             | 67              | (70)EX TH | 191.0 x 130.0 x 2.0 7.52 x 5.12 x 0.079   |
| 884532                                | FM3948MP        | STEEL     | -----             | 67              | (70)EX TH | 191.0 x 130.0 x 2.5 7.52 x 5.12 x 0.098   |
| 884533                                | FM3946MP        | STEEL     | -----             | 67              | (70)EX TH | 191.0 x 130.0 x 3.0 7.52 x 5.12 x 0.118   |
| 884534                                | FM3575          | PAPER     | 3 PASS            | 35              | INT TH    | 179.0 x 103.0 x 3.5 7.05 x 4.05 x 0.138   |
| 887027                                | FM4686MP        | STEEL     | -----             | 81              | EXT TH    | 243.6 x 152.1 x 2.5 9.59 x 5.99 x 0.098   |
| 887028                                | FM6120-3.0      | STEEL     | -----             | 81              | EXT TH    | 243.5 x 153.0 x 3.0 9.59 x 6.02 x 0.118   |
| 887029                                | FM6896MP        | STEEL     | -----             | 81              | EXT TH    | 243.6 x 152.1 x 2.0 9.59 x 5.99 x 0.079   |
| 887030                                | FM4089          | PAPER     | 3 PASS            | 48              | INT TH    | 232.7 x 142.0 x 4.0 9.16 x 5.59 x 0.157   |
| 1139717                               | FM6715          | CARBON PA | WAFFLE            | 8               | EXT LG    | 262.7 x 155.0 x 4.5 10.34 x 6.1 x 0.177   |
| 1139718                               | FM7132-2.5      | STEEL     | -----             | 36              | (48)IN TH | 236.0 x 144.2 x 2.5 9.29 x 5.68 x 0.098   |
| 2055300                               | FM9329          | PAPER     | WAFFLE            | 33              | INT TH    | 361.6 x 122.5 x 6.2 14.24 x 4.82 x 0.244  |
| 2055315                               | FM9327          | PAPER     | WAFFLE            | 33              | INT TH    | 387.5 x 122.5 x 6.2 15.26 x 4.82 x 0.244  |
| 2055335                               | FM4831          | PAPER     | 2 PASS            | 26              | INT TH    | 160.0 x 97.5 x 2.2 6.3 x 3.84 x 0.087     |
| 2055338                               | FM2914MP        | STEEL     | -----             | 68              | EXT TH    | 174.1 x 110.0 x 1.7 6.85 x 4.33 x 0.066   |
| 2056132                               | FM4317          | PAPER     | WAFFLE            | 33              | INT TH    | 344.0 x 122.5 x 6.2 13.54 x 4.82 x 0.244  |
| 3032432                               | FM3192MP        | STEEL     | -----             | 46              | (63)EX TH | 162.0 x 132.0 x 1.8 6.38 x 5.2 x 0.07     |
| 3036156                               | FM6484MP        | STEEL     | -----             | 20              | (28)EX TH | 74.0 x 49.4 x 1.9 2.91 x 1.94 x 0.073     |
| 3036157                               | FM6481          | PAPER     | 2 PASS            | 12              | (14)IN TH | 67.8 x 35.4 x 3.2 2.67 x 1.39 x 0.126     |
| 3037401                               | FM3189          | PAPER     | -----             | 29              | (46)IN TH | 156.0 x 115.0 x 3.3 6.14 x 4.53 x 0.129   |
| 3064191                               | FM3456MP        | STEEL     | -----             | 32              | (36)EX TH | 94.2 x 70.4 x 1.8 3.71 x 2.77 x 0.07      |
| 3064192                               | FM3453          | PAPER     | 2 PASS            | 14              | INT TH    | 88.3 x 35.3 x 3.3 3.48 x 1.39 x 0.129     |
| 3070674                               | FM6481          | PAPER     | 2 PASS            | 12              | (14)IN TH | 67.8 x 35.4 x 3.2 2.67 x 1.39 x 0.126     |

| REPLACES<br>OEM PT.NO.  | FMC<br>PART NO. | MATERIAL               | GROOVE<br>DETAILS | TEETH/<br>TANGS | SIZE MM   |       |   | SIZE INCH |   |     |       |   |      |   |       |
|-------------------------|-----------------|------------------------|-------------------|-----------------|-----------|-------|---|-----------|---|-----|-------|---|------|---|-------|
| 3070675                 | FM6484MP        | STEEL                  | -----             | 20              | (28)EX TH | 74.0  | x | 49.4      | x | 1.9 | 2.91  | x | 1.94 | x | 0.073 |
| 3502034                 | FM5405          | BRONZE                 | SUNBURST          | 76              | INT TH    | 245.0 | x | 190.0     | x | 2.9 | 9.65  | x | 7.48 | x | 0.112 |
| ?                       | FM5485          | BRONZE                 | SPR/WAG           | 50              | INT TH    | 216.0 | x | 145.7     | x | 4.0 | 8.5   | x | 5.74 | x | 0.157 |
| ?                       | FM5488MP        | STEEL                  | -----             | 76              | (88)EX TH | 232.3 | x | 166.0     | x | 3.2 | 9.15  | x | 6.54 | x | 0.126 |
| <b>HOWARD ROTAVATOR</b> |                 |                        |                   |                 |           |       |   |           |   |     |       |   |      |   |       |
| 650347                  | FM0741          | BRONZE                 | -----             | 6               | EXT LG    | 171.5 | x | 84.1      | x | 4.4 | 6.75  | x | 3.31 | x | 0.175 |
| <b>HURTH (DANA)</b>     |                 |                        |                   |                 |           |       |   |           |   |     |       |   |      |   |       |
| TBA                     | FM4742MP        | STEEL                  | -----             | 1               | EXT SL    | 149.0 | x | 80.0      | x | 2.7 | 5.87  | x | 3.15 | x | 0.105 |
| 0.72744                 | FM2783          | GRAPHITE               | SUNBURST          | 19              | INT TH    | 143.0 | x | 34.0      | x | 4.8 | 5.63  | x | 1.34 | x | 0.189 |
| 111.04.045.01           | FM8153          | PAPER                  | WAFFLE            | 27              | INT TH    | 81.5  | x | 53.0      | x | 1.6 | 3.21  | x | 2.09 | x | 0.063 |
| 111.07.001.02           | FM8116MP        | STEEL                  | -----             | 3               | EXT LG    | 189.6 | x | 130.5     | x | 3.7 | 7.46  | x | 5.14 | x | 0.146 |
| 111.07.015.03           | FM6980MP        | STEEL                  | -----             | 4               | EXT LG    | 199.7 | x | 114.0     | x | 3.7 | 7.86  | x | 4.49 | x | 0.146 |
| 111.07.015.06           | FM6980MP        | STEEL                  | -----             | 4               | EXT LG    | 199.7 | x | 114.0     | x | 3.7 | 7.86  | x | 4.49 | x | 0.146 |
| 111.07.610.01           | FM9379          | PAPER                  | WAFFLE            | 24              | INT TH    | 178.0 | x | 69.0      | x | 3.8 | 7.01  | x | 2.72 | x | 0.148 |
| 112.07.006.01           | FM4606MP        | STEEL                  | -----             | 3               | EXT LG    | 216.9 | x | 144.0     | x | 2.7 | 8.54  | x | 5.67 | x | 0.106 |
| 112.07.006.06           | FM4606MP        | STEEL                  | -----             | 3               | EXT LG    | 216.9 | x | 144.0     | x | 2.7 | 8.54  | x | 5.67 | x | 0.106 |
| 112.07.610.02           | FM4625          | PAPER                  | SUNBURST          | 16              | INT TH    | 201.0 | x | 40.5      | x | 4.9 | 7.91  | x | 1.59 | x | 0.192 |
| 112.07.610.03           | FM7201          | USE FM4625 AFTER STOCK |                   | 16              | INT TH    | 201.0 | x | 40.5      | x | 4.9 | 7.91  | x | 1.59 | x | 0.192 |
| 112.07.610.04           | FM4625          | PAPER                  | SUNBURST          | 16              | INT TH    | 201.0 | x | 40.5      | x | 4.9 | 7.91  | x | 1.59 | x | 0.192 |
| 112.07.611.02           | FM6977          | PAPER                  | WAFFLE            | 54              | INT TH    | 178.0 | x | 105.6     | x | 3.8 | 7.01  | x | 4.16 | x | 0.148 |
| 112.07.613.01           | FM8599          | CARBON PA              | SUNBURST          | 16              | INT TH    | 201.0 | x | 40.5      | x | 4.9 | 7.91  | x | 1.59 | x | 0.192 |
| 113.07.610.01           | FM6127          | PAPER                  | WAFFLE            | 24              | INT TH    | 253.0 | x | 69.0      | x | 6.1 | 9.96  | x | 2.72 | x | 0.24  |
| 114.07.006.01           | FM9392MP        | STEEL                  | -----             | 3               | EXT LG    | 317.6 | x | 225.6     | x | 4.5 | 12.5  | x | 8.88 | x | 0.177 |
| 114.07.610.01           | FM9389          | PAPER                  | WAFFLE            | 38              | INT TH    | 299.3 | x | 114.3     | x | 6.0 | 11.78 | x | 4.5  | x | 0.236 |
| 138.07.006.02           | FM8604MP        | STEEL                  | -----             | 4               | EXT LG    | 250.7 | x | 179.9     | x | 5.0 | 9.87  | x | 7.08 | x | 0.197 |
| 138.07.610.03           | FM8601          | PAPER                  | WAFFLE            | 14              | INT TH    | 229.0 | x | 45.0      | x | 5.7 | 9.02  | x | 1.77 | x | 0.224 |
| 154.07.001.01           | FM6130MP        | STEEL                  | -----             | 3               | EXT LG    | 268.0 | x | 176.0     | x | 4.5 | 10.55 | x | 6.93 | x | 0.177 |
| 154.07.001.06           | FM6130MP        | STEEL                  | -----             | 3               | EXT LG    | 268.0 | x | 176.0     | x | 4.5 | 10.55 | x | 6.93 | x | 0.177 |
| 154.07.610.06           | FM6125          | PAPER                  | WAFFLE            | 28              | (32)IN TH | 253.0 | x | 160.0     | x | 6.1 | 9.96  | x | 6.3  | x | 0.24  |
| 171.04.009.01           | FM8060MP        | STEEL                  | HARDENED          | 4               | EXT LG    | 78.8  | x | 46.2      | x | 1.5 | 3.1   | x | 1.82 | x | 0.059 |
| 171.04.010.03           | FM8055          | MOLYBDENUM             | RADIAL            | 21              | INT TH    | 65.8  | x | 38.5      | x | 1.6 | 2.59  | x | 1.52 | x | 0.063 |
| 171.04.010.04           | FM8057          | MOLY/STEEL             | RADIAL            | 21              | INT TH    | 65.8  | x | 38.5      | x | 3.1 | 2.59  | x | 1.52 | x | 0.122 |
| 171.07.002.03           | FM2890MP        | STEEL                  | -----             | 3               | EXT LG    | 180.0 | x | 111.0     | x | 2.7 | 7.09  | x | 4.37 | x | 0.105 |
| 171.07.610.033          | FM2715          | PAPER                  | 2 PASS            | 19              | INT TH    | 152.0 | x | 34.0      | x | 4.8 | 5.98  | x | 1.34 | x | 0.189 |
| 176.04.037.01           | FM6922MP        | STEEL                  | HARDENED          | 4               | EXT LG    | 122.6 | x | 72.2      | x | 1.8 | 4.83  | x | 2.84 | x | 0.071 |
| 176.04.038.01           | FM5407          | MOLYBDENUM             | RADIAL            | 34              | INT TH    | 109.8 | x | 66.0      | x | 1.3 | 4.32  | x | 2.6  | x | 0.052 |
| 176.04.038.02           | FM5409          | MOLYBDENUM/STEEL       | RADIAL            | 34              | INT TH    | 109.8 | x | 66.0      | x | 2.9 | 4.32  | x | 2.6  | x | 0.112 |
| 734.07.004.013          | FM2344MP        | STEEL                  | -----             | 6               | EXT LG    | 220.0 | x | 145.5     | x | 2.7 | 8.66  | x | 5.73 | x | 0.105 |
| 734.07.004.02           | FM2344MP        | STEEL                  | -----             | 6               | EXT LG    | 220.0 | x | 145.5     | x | 2.7 | 8.66  | x | 5.73 | x | 0.105 |
| 734.07.610.013          | FM2341          | BRONZE                 | SUNBURST          | 16              | INT TH    | 202.9 | x | 40.4      | x | 4.9 | 7.99  | x | 1.59 | x | 0.192 |
| 734.07.610.04           | FM2341          | BRONZE                 | SUNBURST          | 16              | INT TH    | 202.9 | x | 40.4      | x | 4.9 | 7.99  | x | 1.59 | x | 0.192 |
| 734.07.610.22           | FM4625          | PAPER                  | SUNBURST          | 16              | INT TH    | 201.0 | x | 40.5      | x | 4.9 | 7.91  | x | 1.59 | x | 0.192 |
| 738.07.005.013          | FM2184MP        | STEEL                  | -----             | 3               | EXT SL    | 201.7 | x | 129.5     | x | 2.7 | 7.94  | x | 5.1  | x | 0.106 |
| 738.07.005.03           | FM2184MP        | STEEL                  | -----             | 3               | EXT SL    | 201.7 | x | 129.5     | x | 2.7 | 7.94  | x | 5.1  | x | 0.106 |
| 738.07.005.04           | FM2184MP        | STEEL                  | -----             | 3               | EXT SL    | 201.7 | x | 129.5     | x | 2.7 | 7.94  | x | 5.1  | x | 0.106 |
| 738.07.072.02           | FM2632MP        | STEEL                  | -----             | 6               | EXT LG    | 199.0 | x | 130.0     | x | 2.6 | 7.83  | x | 5.12 | x | 0.102 |

| REPLACES<br>OEM PT.NO. | FMC<br>PART NO. | MATERIAL  | GROOVE<br>DETAILS | TEETH/<br>TANGS |           | SIZE MM |   |       | SIZE INCH |      |       |   |      |   |       |
|------------------------|-----------------|-----------|-------------------|-----------------|-----------|---------|---|-------|-----------|------|-------|---|------|---|-------|
| 738.07.610.013         | FM2181          | BRONZE    | SUNBURST          | 19              | INT TH    | 177.8   | x | 34.3  | x         | 4.8  | 7.0   | x | 1.35 | x | 0.189 |
| 738.07.610.06          | FM2181          | BRONZE    | SUNBURST          | 19              | INT TH    | 177.8   | x | 34.3  | x         | 4.8  | 7.0   | x | 1.35 | x | 0.189 |
| 738.07.610.042         | FM2647          | PAPER     | 2 PASS            | 19              | IN TH     | 178.0   | x | 34.0  | x         | 4.8  | 7.01  | x | 1.34 | x | 0.189 |
| <b>HURTH MARINE</b>    |                 |           |                   |                 |           |         |   |       |           |      |       |   |      |   |       |
| 288757                 | FM5175          | BRONZE    | SPIRAL            | 22              | INT TH    | 67.8    | x | 41.0  | x         | 1.6  | 2.67  | x | 1.61 | x | 0.061 |
| 288889                 | FM4979          | BRONZE    | SPIRAL            | 24              | (27)IN TH | 88.0    | x | 53.0  | x         | 1.7  | 3.46  | x | 2.09 | x | 0.064 |
| <b>HYDREMA</b>         |                 |           |                   |                 |           |         |   |       |           |      |       |   |      |   |       |
| 593068                 | FM4015          | GRAPHITE  | SUNBURST          | 27              | INT TH    | 303.8   | x | 66.1  | x         | 10.0 | 11.96 | x | 2.6  | x | 0.393 |
| 593069                 | FM4015          | GRAPHITE  | SUNBURST          | 27              | INT TH    | 303.8   | x | 66.1  | x         | 10.0 | 11.96 | x | 2.6  | x | 0.393 |
| 593528                 | FM2777          | GRAPHITE  | SUNBURST          | 27              | INT TH    | 260.0   | x | 66.1  | x         | 10.0 | 10.24 | x | 2.6  | x | 0.394 |
| 7000045                | FM3414MP        | END PLATE | -----             | 32              | (64)EX TH | 230.0   | x | 152.5 | x         | 10.8 | 9.06  | x | 6.0  | x | 0.397 |
| 7000046                | FM2823          | PAPER     | 2 PASS            | 36              | INT TH    | 223.0   | x | 71.0  | x         | 4.9  | 8.78  | x | 2.8  | x | 0.191 |
| 7000047                | FM3912MP        | END PLATE | -----             | 64              | EXT TH    | 230.0   | x | 152.5 | x         | 5.0  | 9.06  | x | 6.0  | x | 0.197 |
| 7000570                | FM7337          | PAPER     | 2 PASS            | 36              | INT TH    | 223.0   | x | 71.0  | x         | 4.9  | 8.78  | x | 2.8  | x | 0.191 |
| 7002739                | FM7797          | GRAPHITE  | SUNBURST          | 45              | (54)IN TH | 298.0   | x | 106.0 | x         | 5.0  | 11.73 | x | 4.17 | x | 0.197 |
| 7003389                | FM8263          | BRONZE    | WAF/RAD           | 54              | EXT TH    | 109.4   | x | 82.1  | x         | 1.6  | 4.31  | x | 3.23 | x | 0.063 |
| 7003390                | FM8816MP        | STEEL     | HARDENED          | 52              | INT TH    | 102.0   | x | 77.2  | x         | 1.5  | 4.02  | x | 3.04 | x | 0.059 |
| 14000691               | FM3575          | PAPER     | 3 PASS            | 35              | INT TH    | 179.0   | x | 103.0 | x         | 3.5  | 7.05  | x | 4.05 | x | 0.138 |
| 14001560               | FM4844MP        | STEEL     | -----             | 67              | (70)EX TH | 191.0   | x | 130.0 | x         | 2.0  | 7.52  | x | 5.12 | x | 0.079 |
| 14001561               | FM3948MP        | STEEL     | -----             | 67              | (70)EX TH | 191.0   | x | 130.0 | x         | 2.5  | 7.52  | x | 5.12 | x | 0.098 |
| 14001562               | FM3946MP        | STEEL     | -----             | 67              | (70)EX TH | 191.0   | x | 130.0 | x         | 3.0  | 7.52  | x | 5.12 | x | 0.118 |
| <b>HYSTER</b>          |                 |           |                   |                 |           |         |   |       |           |      |       |   |      |   |       |
| 77806                  | FM1933          | BRONZE    | RADIAL            | 59              | INT TH    | 190.8   | x | 147.3 | x         | 3.0  | 7.51  | x | 5.8  | x | 0.118 |
| 77808                  | FM1938MP        | STEEL     | -----             | 3               | EXT LG    | 214.9   | x | 155.7 | x         | 1.8  | 8.46  | x | 6.13 | x | 0.07  |
| 77885                  | FM5442MP        | STEEL     | END PLATE         | 54              | EXT TH    | 139.2   | x | 98.2  | x         | 8.3  | 5.48  | x | 3.87 | x | 0.327 |
| 77888                  | FM1359          | BRONZE    | SPIRAL            | 45              | INT TH    | 133.1   | x | 92.7  | x         | 1.6  | 5.24  | x | 3.65 | x | 0.063 |
| 77889                  | FM5452MP        | STEEL     | END PLATE         | 54              | EXT TH    | 139.2   | x | 98.2  | x         | 8.7  | 5.48  | x | 3.87 | x | 0.343 |
| 77898                  | FM1324MP        | STEEL     | -----             | 54              | EXT TH    | 139.2   | x | 98.6  | x         | 1.8  | 5.48  | x | 3.88 | x | 0.07  |
| 78803                  | FM1348MP        | STEEL     | -----             | 12              | EXT LG    | 304.8   | x | 212.6 | x         | 2.5  | 12    | x | 8.37 | x | 0.098 |
| 78804                  | FM2151          | BRONZE    | SUN/WAG           | 64              | INT TH    | 269.7   | x | 197.1 | x         | 3.5  | 10.62 | x | 7.76 | x | 0.138 |
| 95471                  | OBSOLETE        | STEEL     | -----             | 40              | INT TH    | 254.0   | x | 163.2 | x         | 2.1  | 10    | x | 6.43 | x | 0.082 |
| 96464                  | FM1838MP        | STEEL     | -----             | 50              | INT TH    | 215.9   | x | 153.9 | x         | 2.0  | 8.5   | x | 6.06 | x | 0.079 |
| 96465                  | FM2321          | BRONZE    | SPR/WAG           | 72              | (88)EX TH | 227.8   | x | 165.1 | x         | 3.2  | 8.97  | x | 6.5  | x | 0.125 |
| 106375                 | FM1276MP        | STEEL     | DISHED            | 50              | (54)EX TH | 138.9   | x | 98.0  | x         | 1.8  | 5.47  | x | 3.86 | x | 0.07  |
| 109604                 | FM3701          | PAPER     | 2 PASS            | 43              | (45)IN TH | 133.1   | x | 92.7  | x         | 2.1  | 5.24  | x | 3.65 | x | 0.084 |
| 113486                 | FM1233          | BRONZE    | SPR/WAG           | 20              | INT TH    | 168.9   | x | 78.5  | x         | 3.3  | 6.65  | x | 3.09 | x | 0.13  |
| 114254                 | FM1274MP        | STEEL     | -----             | 20              | (28)EX TH | 191.3   | x | 117.3 | x         | 2.0  | 7.53  | x | 4.62 | x | 0.079 |
| 119729                 | FM1233          | BRONZE    | SPR/WAG           | 20              | INT TH    | 168.9   | x | 78.5  | x         | 3.3  | 6.65  | x | 3.09 | x | 0.13  |
| 119751                 | FM1274MP        | STEEL     | -----             | 20              | (28)EX TH | 191.3   | x | 117.3 | x         | 2.0  | 7.53  | x | 4.62 | x | 0.079 |
| 131923                 | OBSOLETE        | BRONZE    | SPR/WAG           | 103             | EXT TH    | 265.4   | x | 177.8 | x         | 3.2  | 10.45 | x | 7.0  | x | 0.125 |
| 133917                 | FM2321          | BRONZE    | SPR/WAG           | 72              | (88)EX TH | 227.8   | x | 165.1 | x         | 3.2  | 8.97  | x | 6.5  | x | 0.125 |
| 148895                 | FM1233          | BRONZE    | SPR/WAG           | 20              | INT TH    | 168.9   | x | 78.5  | x         | 3.3  | 6.65  | x | 3.09 | x | 0.13  |
| 175198                 | FM3669          | GRAPHITE  | SUNBURST          | 64              | INT TH    | 269.7   | x | 197.1 | x         | 3.5  | 10.62 | x | 7.76 | x | 0.138 |

| REPLACES<br>OEM PT.NO. | FMC<br>PART NO. | MATERIAL  | GROOVE<br>DETAILS | TEETH/<br>TANGS | SIZE MM   |       |   | SIZE INCH |   |     |       |   |       |   |       |
|------------------------|-----------------|-----------|-------------------|-----------------|-----------|-------|---|-----------|---|-----|-------|---|-------|---|-------|
| 180287                 | FM2151          | BRONZE    | SUN/WAG           | 64              | INT TH    | 269.7 | x | 197.1     | x | 3.5 | 10.62 | x | 7.76  | x | 0.138 |
| 234215                 | FM1965          | BRONZE    | SPR/WAG           | 60              | INT TH    | 253.7 | x | 187.5     | x | 3.9 | 9.99  | x | 7.38  | x | 0.153 |
| 239198                 | OBSOLETE        | STEEL     | -----             | 56              | INT TH    | 203.2 | x | 138.7     | x | 2.3 | 8.0   | x | 5.46  | x | 0.091 |
| 261542                 | FM1838MP        | STEEL     | -----             | 50              | INT TH    | 215.9 | x | 153.9     | x | 2.0 | 8.5   | x | 6.06  | x | 0.079 |
| 261544                 | FM1839          | PAPER     | 2 PASS            | 72              | (88)EX TH | 227.8 | x | 165.1     | x | 3.2 | 8.97  | x | 6.5   | x | 0.126 |
| 264062                 | FM3074MP        | OBSOLETE  | -----             | 40              | INT TH    | 254.0 | x | 163.3     | x | 2.1 | 10.0  | x | 6.43  | x | 0.082 |
| 282726                 | FM2151          | BRONZE    | SUN/WAG           | 64              | INT TH    | 269.7 | x | 197.1     | x | 3.5 | 10.62 | x | 7.76  | x | 0.138 |
| 292989                 | FM3700MP        | STEEL     | -----             | 12              | EXT LG    | 304.8 | x | 212.6     | x | 2.5 | 12.0  | x | 8.37  | x | 0.098 |
| 292990                 | FM2151          | BRONZE    | SUN/WAG           | 64              | INT TH    | 269.7 | x | 197.1     | x | 3.5 | 10.62 | x | 7.76  | x | 0.138 |
| 298025                 | FM2151          | BRONZE    | SUN/WAG           | 64              | INT TH    | 269.7 | x | 197.1     | x | 3.5 | 10.62 | x | 7.76  | x | 0.138 |
| 299646                 | FM1279          | PAPER     | 2 PASS            | 52              | INT TH    | 148.6 | x | 107.7     | x | 1.8 | 5.85  | x | 4.24  | x | 0.07  |
| 311246                 | FM2151          | BRONZE    | SUN/WAG           | 64              | INT TH    | 269.7 | x | 197.1     | x | 3.5 | 10.62 | x | 7.76  | x | 0.138 |
| 319516                 | FM3650MP        | STEEL     | -----             | 54              | EXT TH    | 139.2 | x | 98.6      | x | 3.0 | 5.48  | x | 3.88  | x | 0.118 |
| 319596                 | FM3650MP        | STEEL     | -----             | 54              | EXT TH    | 139.2 | x | 98.6      | x | 3.0 | 5.48  | x | 3.88  | x | 0.118 |
| 319597                 | FM3701          | PAPER     | 2 PASS            | 43              | (45)IN TH | 133.1 | x | 92.7      | x | 2.1 | 5.24  | x | 3.65  | x | 0.084 |
| 328154                 | FM3671          | PAPER     | 2 PASS            | 64              | INT TH    | 269.7 | x | 197.1     | x | 3.5 | 10.62 | x | 7.76  | x | 0.138 |
| 328714                 | OBSOLETE        | PAPER     | 2 PASS            | 48              | EXT TH    | 186.9 | x | 136.9     | x | 3.2 | 7.36  | x | 5.39  | x | 0.125 |
| 328715                 | FM1839          | PAPER     | 2 PASS            | 72              | (88)EX TH | 227.8 | x | 165.1     | x | 3.2 | 8.97  | x | 6.5   | x | 0.126 |
| 328716                 | OBSOLETE        | PAPER     | 2 PASS            | 87              | EXT TH    | 265.4 | x | 177.8     | x | 3.2 | 10.45 | x | 7.0   | x | 0.125 |
| 330618                 | FM7462MP        | END PLATE | -----             | 60              | EXT TH    | 154.3 | x | 113.5     | x | 8.0 | 6.07  | x | 4.47  | x | 0.315 |
| 330619                 | FM1307OE        | BRONZE    | RADIAL            | 52              | INT TH    | 148.6 | x | 107.7     | x | 2.6 | 5.85  | x | 4.24  | x | 0.102 |
| 330620                 | FM1216MP        | STEEL     | -----             | 60              | EXT TH    | 154.2 | x | 113.8     | x | 1.8 | 6.07  | x | 4.48  | x | 0.07  |
| 330625                 | FM1305OE        | BRONZE    | RADIAL            | 52              | INT TH    | 148.6 | x | 107.7     | x | 2.6 | 5.85  | x | 4.24  | x | 0.102 |
| 334409                 | FM3701          | PAPER     | 2 PASS            | 43              | (45)IN TH | 133.1 | x | 92.7      | x | 2.1 | 5.24  | x | 3.65  | x | 0.084 |
| 334417                 | FM3650MP        | STEEL     | -----             | 54              | EXT TH    | 139.2 | x | 98.6      | x | 3.0 | 5.48  | x | 3.88  | x | 0.118 |
| 334442                 | FM8616MP        | END PLATE | STEPPED           | 54              | EXT TH    | 138.7 | x | 98.1      | x | 8.9 | 5.46  | x | 3.86  | x | 0.35  |
| 338573                 | FM3701          | PAPER     | 2 PASS            | 43              | (45)IN TH | 133.1 | x | 92.7      | x | 2.1 | 5.24  | x | 3.65  | x | 0.084 |
| 346796                 | FM3701          | PAPER     | 2 PASS            | 43              | (45)IN TH | 133.1 | x | 92.7      | x | 2.1 | 5.24  | x | 3.65  | x | 0.084 |
| 382263                 | FM1381OE        | BRONZE    | RADIAL            | 52              | INT TH    | 148.6 | x | 107.7     | x | 2.9 | 5.85  | x | 4.24  | x | 0.114 |
| 382945                 | FM3024MP        | STEEL     | -----             | 12              | EXT LG    | 317.7 | x | 268.0     | x | 3.0 | 12.51 | x | 10.55 | x | 0.118 |
| 385432                 | FM3242BP        | BACKPLATE | 32HOLES           |                 |           | 354.0 | x | 314.0     | x | 4.0 | 13.94 | x | 12.36 | x | 0.157 |
| 449273                 | FM1324MP        | STEEL     | -----             | 54              | EXT TH    | 139.2 | x | 98.6      | x | 1.8 | 5.48  | x | 3.88  | x | 0.07  |
| 449461                 | FM1337OE        | BRONZE    | RADIAL            | 45              | INT TH    | 133.1 | x | 92.7      | x | 2.3 | 5.24  | x | 3.65  | x | 0.09  |
| 878364                 | FM1276MP        | STEEL     | DISHED            | 50              | (54)EX TH | 138.9 | x | 98.0      | x | 1.8 | 5.47  | x | 3.86  | x | 0.07  |
| 1311645                | FM4253          | PAPER     | 2 PASS            | 45              | INT TH    | 133.3 | x | 92.6      | x | 2.4 | 5.25  | x | 3.65  | x | 0.095 |
| 1311652                | FM1337OE        | BRONZE    | RADIAL            | 45              | INT TH    | 133.1 | x | 92.7      | x | 2.3 | 5.24  | x | 3.65  | x | 0.09  |
| 1311653                | FM1324MP        | STEEL     | -----             | 54              | EXT TH    | 139.2 | x | 98.6      | x | 1.8 | 5.48  | x | 3.88  | x | 0.07  |
| 1311662                | FM1337OE        | BRONZE    | RADIAL            | 45              | INT TH    | 133.1 | x | 92.7      | x | 2.3 | 5.24  | x | 3.65  | x | 0.09  |
| 1339374                | FM4486MP        | STEEL     | HARDENED          | 60              | EXT TH    | 154.2 | x | 113.8     | x | 1.8 | 6.07  | x | 4.48  | x | 0.07  |
| 1382885                | FM4726MP        | STEEL     | -----             | 46              | EXT TH    | 241.1 | x | 161.7     | x | 3.8 | 9.49  | x | 6.37  | x | 0.15  |
| 1384873                | FM1326MP        | STEEL     | -----             | 72              | (90)EX TH | 462.0 | x | 350.0     | x | 3.5 | 18.19 | x | 13.78 | x | 0.138 |
| 1387235                | FM3346MP        | STEEL     | -----             | 54              | EXT TH    | 139.2 | x | 98.6      | x | 2.5 | 5.48  | x | 3.88  | x | 0.1   |
| 1389176                | FM2738MP        | STEEL     | -----             | 71              | EXT TH    | 182.6 | x | 117.9     | x | 1.8 | 7.19  | x | 4.64  | x | 0.069 |
| 1390854                | FM2279          | BRONZE    | SUNBURST          | 35              | EXT TH    | 177.5 | x | 109.0     | x | 2.0 | 6.99  | x | 4.29  | x | 0.079 |
| 1390929                | FM2277          | BRONZE    | SUNBURST          | 27              | EXT TH    | 137.4 | x | 90.9      | x | 2.0 | 5.41  | x | 3.58  | x | 0.079 |
| 1390930                | FM3592MP        | STEEL     | -----             | 29              | INT TH    | 131.1 | x | 85.1      | x | 1.5 | 5.16  | x | 3.35  | x | 0.059 |
| 1390931                | FM3594MP        | STEEL     | -----             | 29              | INT TH    | 131.1 | x | 85.1      | x | 2.0 | 5.16  | x | 3.35  | x | 0.079 |
| 1390932                | FM3596MP        | STEEL     | -----             | 29              | INT TH    | 131.1 | x | 85.1      | x | 2.5 | 5.16  | x | 3.35  | x | 0.098 |

| REPLACES<br>OEM PT.NO. | FMC<br>PART NO. | MATERIAL                                | GROOVE<br>DETAILS | TEETH/<br>TANGS | SIZE MM   |                                     |   | SIZE INCH |   |     |       |   |       |   |       |
|------------------------|-----------------|---|-------------------|-----------------|-----------|-------------------------------------|---|-----------|---|-----|-------|---|-------|---|-------|
| 1392401                | FM3573          | PAPER                                   | 2 PASS            | 35              | EXT TH    | 177.5                               | x | 109.0     | x | 2.0 | 6.99  | x | 4.29  | x | 0.079 |
| 1394881                | FM4012MP        | END PLATE                               | -----             | 54              | EXT TH    | 138.8                               | x | 98.8      | x | 6.3 | 5.46  | x | 3.89  | x | 0.248 |
| 1452826                | FM4723          | PAPER                                   | WAF/RAD           | 22              | INT TH    | 228.6                               | x | 66.8      | x | 3.2 | 9.0   | x | 2.63  | x | 0.125 |
| 1469300                | FM3343          | PAPER                                   | 2 PASS            | 45              | INT TH    | 133.1                               | x | 92.7      | x | 2.5 | 5.24  | x | 3.65  | x | 0.1   |
| 1469301                | FM3343          | PAPER                                   | 2 PASS            | 45              | INT TH    | 133.1                               | x | 92.7      | x | 2.5 | 5.24  | x | 3.65  | x | 0.1   |
| 1489439                | FM8354MP        | STEEL                                   | -----             | 8               | EXT LG    | 389.7                               | x | 220.0     | x | 4.6 | 15.34 | x | 8.66  | x | 0.179 |
| 1489440                | FM8351          | AFP                                     | WAFFLE            | 43              | (49)IN TH | 360.0                               | x | 202.7     | x | 5.3 | 14.17 | x | 7.98  | x | 0.209 |
| 1510563                | FM4998MP        | STEEL                                   | -----             | 45              | INT TH    | 133.0                               | x | 92.7      | x | 2.0 | 5.24  | x | 3.65  | x | 0.079 |
| 1510564                | FM4993          | PAPER                                   | 2 PASS            | 54              | EXT TH    | 139.0                               | x | 99.0      | x | 2.7 | 5.47  | x | 3.9   | x | 0.104 |
| 1532251                | FM6093          | AFP                                     | WAFFLE            | 60              | INT TH    | 450.0                               | x | 300.0     | x | 5.3 | 17.72 | x | 11.81 | x | 0.209 |
| 1538176                | FM3701          | PAPER                                   | 2 PASS            | 43              | (45)IN TH | 133.1                               | x | 92.7      | x | 2.1 | 5.24  | x | 3.65  | x | 0.084 |
| 1543102                | FM4983KIT       | KIT                                     |                   |                 |           | 5 x PAPER, 4 x STEEL, 1 x END PLATE |   |           |   |     |       |   |       |   |       |
| FM4983KIT              | FM4983          | PAPER                                   | WAFFLE            | 38              | INT TH    | 133.6                               | x | 77.0      | x | 3.0 | 5.26  | x | 3.03  | x | 0.116 |
| FM4983KIT              | FM4986MP        | STEEL                                   | -----             | 34              | EXT TH    | 143.0                               | x | 87.5      | x | 2.3 | 5.63  | x | 3.44  | x | 0.09  |
| FM4983KIT              | FM4988MP        | STEEL                                   | DISHED            | 34              | EXT TH    | 143.0                               | x | 87.5      | x | 2.7 | 5.63  | x | 3.44  | x | 0.106 |
| 1537449                | FM8288MP        | STEEL                                   | -----             | 34              | EXT TH    | 143.0                               | x | 87.5      | x | 6.0 | 5.63  | x | 3.44  | x | 0.236 |
| 1556964                | FM6343          | PAPER                                   | WAFFLE            | 45              | INT TH    | 133.3                               | x | 92.8      | x | 2.6 | 5.25  | x | 3.65  | x | 0.102 |
| 1556965                | FM3658MP        | STEEL                                   | -----             | 54              | EXT TH    | 139.0                               | x | 99.0      | x | 2.0 | 5.47  | x | 3.9   | x | 0.079 |
| 1566651                | FM2787          | GRAPHITE                                | SUNBURST          | 52              | INT TH    | 175.3                               | x | 106.7     | x | 2.9 | 6.9   | x | 4.2   | x | 0.114 |
| 1566651                | FM6999          | GRAPHITE                                | SUNB/HARDENED     | 52              | INT TH    | 175.3                               | x | 106.7     | x | 2.9 | 6.9   | x | 4.2   | x | 0.114 |
| 1582269                | FM6653KIT       | 18 X PAPER + 16 X STEEL + 2 X END PLATE |                   |                 |           |                                     |   |           |   |     |       |   |       |   |       |
| 1612501                | FM6018MP        | STEEL                                   | -----             | 78              | EXT TH    | 200.0                               | x | 114.0     | x | 3.0 | 7.87  | x | 4.49  | x | 0.118 |
| 1612549                | FM6016MP        | STEEL                                   | -----             | 78              | EXT TH    | 200.0                               | x | 114.0     | x | 2.3 | 7.87  | x | 4.49  | x | 0.089 |
| 1624475                | FM6051          | PAPER                                   | WAFFLE/PLAIN      | 52              | EXT TH    | 167.5                               | x | 114.0     | x | 2.0 | 6.59  | x | 4.49  | x | 0.077 |
| 1624476                | FM6049          | PAPER                                   | WAFFLE            | 52              | EXT TH    | 167.5                               | x | 114.0     | x | 2.6 | 6.59  | x | 4.49  | x | 0.102 |
| 1624477                | FM6054MP        | STEEL                                   | -----             | 52              | INT TH    | 161.0                               | x | 107.0     | x | 2.0 | 6.34  | x | 4.21  | x | 0.079 |
| 1624583                | FM6048MP        | STEEL                                   | -----             | 52              | EXT TH    | 167.5                               | x | 114.0     | x | 2.5 | 6.59  | x | 4.49  | x | 0.098 |
| 1624584                | FM6045          | PAPER                                   | WAFFLE            | 52              | INT TH    | 161.0                               | x | 107.0     | x | 2.9 | 6.34  | x | 4.21  | x | 0.112 |
| 1644930                | FM4998MP        | STEEL                                   | -----             | 45              | INT TH    | 133.0                               | x | 92.7      | x | 2.0 | 5.24  | x | 3.65  | x | 0.079 |
| 1657780                | FM8601          | PAPER                                   | WAFFLE            | 14              | INT TH    | 229.0                               | x | 45.0      | x | 5.7 | 9.02  | x | 1.77  | x | 0.224 |
| 1657781                | FM8604MP        | STEEL                                   | -----             | 4               | EXT LG    | 250.7                               | x | 179.9     | x | 5.0 | 9.87  | x | 7.08  | x | 0.197 |
| 1708942                | FM5376MP        | STEEL                                   | -----             | 45              | INT TH    | 148.3                               | x | 92.7      | x | 2.3 | 5.84  | x | 33.65 | x | 0.089 |
| 3026084                | FM3667          | PAPER                                   | 2 PASS            | 44              | INT TH    | 196.9                               | x | 138.0     | x | 2.8 | 7.75  | x | 5.43  | x | 0.11  |
| 3045537                | FM2314MP        | STEEL                                   | -----             | 8               | EXT LG    | 161.3                               | x | 114.3     | x | 1.8 | 6.35  | x | 4.5   | x | 0.071 |
| 3045538                | FM2309          | PAPER                                   | 2 PASS            | 42              | INT TH    | 149.4                               | x | 107.7     | x | 2.6 | 5.88  | x | 4.24  | x | 0.102 |
| 3045763                | FM1230MP        | STEEL                                   | -----             | 4               | EXT LG    | 155.7                               | x | 115.8     | x | 1.7 | 6.13  | x | 4.56  | x | 0.066 |
| 3046971                | FM3704MP        | STEEL                                   | DISHED            | 8               | EXT LG    | 136.4                               | x | 88.1      | x | 1.2 | 5.37  | x | 3.47  | x | 0.047 |
| 3053215                | FM3701          | PAPER                                   | 2 PASS            | 43              | (45)IN TH | 133.1                               | x | 92.7      | x | 2.1 | 5.24  | x | 3.65  | x | 0.084 |
| 3053354                | FM1309          | BRONZE                                  | RADIAL            | 52              | INT TH    | 148.6                               | x | 107.7     | x | 2.6 | 5.85  | x | 4.24  | x | 0.102 |
| 3068473                | FM3384MP        | STEEL                                   | -----             | 43              | (64)EX TH | 205.5                               | x | 145.4     | x | 3.5 | 8.09  | x | 5.72  | x | 0.138 |
| 3132279                | FM2721          | BRONZE                                  | SUNBURST          | 47              | INT TH    | 147.0                               | x | 90.5      | x | 3.0 | 5.79  | x | 3.56  | x | 0.118 |
| 3258154                | FM3705          | OBSOLETE                                | 2 PASS            | 64              | INT TH    | 269.7                               | x | 197.1     | x | 3.5 | 10.62 | x | 7.76  | x | 0.138 |
| 4001167                | FM6435          | CARBON PA                               | WAFFLE            | 52              | INT TH    | 193.0                               | x | 107.5     | x | 2.6 | 7.6   | x | 4.23  | x | 0.102 |
| 4001168                | FM6437          | CARBON PA                               | WAFFLE            | 60              | EXT TH    | 154.0                               | x | 99.0      | x | 2.7 | 6.06  | x | 3.9   | x | 0.104 |
| 4001169                | FM6439          | CARBON PA                               | WAFFLE/PLAIN      | 60              | EXT TH    | 154.0                               | x | 99.0      | x | 1.9 | 6.06  | x | 3.9   | x | 0.075 |
| 4015492                | FM4993          | PAPER                                   | 2 PASS            | 54              | EXT TH    | 139.0                               | x | 99.0      | x | 2.7 | 5.47  | x | 3.9   | x | 0.104 |
| 4021738                | FM3007          | PAPER                                   | 3 PASS            | 60              | INT TH    | 466.0                               | x | 284.0     | x | 5.6 | 18.35 | x | 11.18 | x | 0.22  |



| REPLACES OEM PT.NO. | FMC PART NO. | MATERIAL    | GROOVE DETAILS | TEETH/TANGS | SIZE MM | SIZE INCH                                |
|---------------------|--------------|-------------|----------------|-------------|---------|--|
| 4021739             | FM5578MP     | STEEL       | -----          | 96          | EXT TH  | 488.0 x 310.0 x 4.0 19.21 x 12.2 x 0.157 |
| 4024120             | FM4789       | PAPER/PLAIN | RADIAL         | 44          | EXT TH  | 158.8 x 111.5 x 1.9 6.25 x 4.39 x 0.075  |
| 4024121             | FM4787       | CARBON PA   | RADIAL         | 44          | EXT TH  | 158.8 x 111.5 x 2.5 6.25 x 4.39 x 0.098  |
| 4024122             | FM4786MP     | STEEL       | -----          | 42          | INT TH  | 167.8 x 102.5 x 2.5 6.61 x 4.04 x 0.098  |
| 4024159             | FM6113       | PAPER/PLAIN | RADIAL         | 27          | EXT TH  | 137.0 x 93.7 x 1.9 5.39 x 3.69 x 0.073   |
| 4024160             | FM6111       | CARBON PA   | RADIAL         | 27          | EXT TH  | 137.0 x 93.7 x 2.5 5.39 x 3.69 x 0.098   |
| 4024161             | FM6116MP     | STEEL       | -----          | 35          | INT TH  | 129.6 x 84.8 x 2.5 5.1 x 3.34 x 0.098    |
| 4052214             | FM4351       | PAPER       | WAFFLE         | 60          | INT TH  | 465.8 x 284.4 x 5.6 18.34 x 11.2 x 0.22  |
| 4080643             | FM4785       | PAPER/PLAIN | RADIAL         | 34          | EXT TH  | 177.4 x 111.5 x 1.9 6.98 x 4.39 x 0.075  |
| 4080644             | FM4783       | CARBON PA   | RADIAL         | 34          | EXT TH  | 177.4 x 111.5 x 2.5 6.98 x 4.39 x 0.098  |

**HYUNDAI (also see CLARK and ZF)**

|            |            |             |          |    |           |  |
|------------|------------|-------------|----------|----|-----------|--|
| 3146363    | FM2997     | PAPER       | 2 PASS   | 72 | INT TH    | 298.0 x 215.0 x 4.5 11.73 x 8.46 x 0.177 |
| 3146743    | FM2995     | PAPER       | 2 PASS   | 54 | INT TH    | 325.0 x 224.0 x 4.5 12.8 x 8.82 x 0.177  |
| 3146763    | FM2991     | PAPER       | 3 PASS   | 57 | INT TH    | 360.0 x 237.0 x 4.5 14.17 x 9.33 x 0.177 |
| 3146793    | FM3640MP   | STEEL       | -----    | 75 | EXT TH    | 315.0 x 226.0 x 3.9 12.4 x 8.9 x 0.154   |
| 3146803    | FM3644MP   | STEEL       | -----    | 75 | EXT TH    | 315.0 x 226.0 x 4.5 12.4 x 8.9 x 0.177   |
| 3146813    | FM3646MP   | STEEL       | -----    | 75 | EXT TH    | 315.0 x 226.0 x 5.0 12.4 x 8.9 x 0.197   |
| 3146823    | FM3630MP   | STEEL       | -----    | 75 | EXT TH    | 345.0 x 243.0 x 3.9 13.58 x 9.57 x 0.154 |
| 3146833    | FM3634MP   | STEEL       | -----    | 75 | EXT TH    | 345.0 x 243.0 x 4.5 13.58 x 9.57 x 0.177 |
| 3146843    | FM3636MP   | STEEL       | -----    | 75 | EXT TH    | 345.0 x 243.0 x 5.0 13.58 x 9.57 x 0.197 |
| 3146853    | FM3620MP   | STEEL       | -----    | 75 | EXT TH    | 383.0 x 253.0 x 3.9 15.08 x 9.96 x 0.154 |
| 3146863    | FM3624MP   | STEEL       | -----    | 75 | EXT TH    | 383.0 x 253.0 x 4.5 15.08 x 9.96 x 0.177 |
| 3146873    | FM3626MP   | STEEL       | -----    | 75 | EXT TH    | 383.0 x 253.0 x 5.0 15.08 x 9.96 x 0.197 |
| 3154543    | FM3642MP   | STEEL       | -----    | 75 | EXT TH    | 315.0 x 226.0 x 4.3 12.4 x 8.9 x 0.167   |
| 3200513    | FM3632MP   | STEEL       | -----    | 75 | EXT TH    | 345.0 x 243.0 x 4.2 13.58 x 9.57 x 0.165 |
| 3200523    | FM3622MP   | STEEL       | -----    | 75 | EXT TH    | 383.0 x 253.0 x 4.3 15.08 x 9.96 x 0.167 |
| 3243233    | FM2991     | PAPER       | 3 PASS   | 57 | INT TH    | 360.0 x 237.0 x 4.5 14.17 x 9.33 x 0.177 |
| 501208883  | FM4397     | BRONZE      | SUNBURST | 64 | EXT TH    | 196.0 x 142.0 x 2.5 7.72 x 5.59 x 0.096  |
| 501208884  | FM4399     | BRNZ/PLN    | SUNBURST | 64 | EXT TH    | 196.0 x 142.0 x 2.0 7.72 x 5.59 x 0.077  |
| 501212370  | FM4783     | CARBON PA   | RADIAL   | 34 | EXT TH    | 177.4 x 111.5 x 2.5 6.98 x 4.39 x 0.098  |
| 501212371  | FM4785     | PAPER/PLAIN | RADIAL   | 34 | EXT TH    | 177.4 x 111.5 x 1.9 6.98 x 4.39 x 0.075  |
| 501212372  | FM4787     | CARBON PA   | RADIAL   | 44 | EXT TH    | 158.8 x 111.5 x 2.5 6.25 x 4.39 x 0.098  |
| 501212373  | FM4789     | PAPER/PLAIN | RADIAL   | 44 | EXT TH    | 158.8 x 111.5 x 1.9 6.25 x 4.39 x 0.075  |
| 501309329  | FM2277     | BRONZE      | SUNBURST | 27 | EXT TH    | 137.4 x 90.9 x 2.0 5.41 x 3.58 x 0.079   |
| 501309330  | FM2279     | BRONZE      | SUNBURST | 35 | EXT TH    | 177.5 x 109.0 x 2.0 6.99 x 4.29 x 0.079  |
| 501314381  | FM3575     | PAPER       | 3 PASS   | 35 | INT TH    | 179.0 x 103.0 x 3.5 7.05 x 4.05 x 0.138  |
| 501314382  | FM4089     | PAPER       | 3 PASS   | 48 | INT TH    | 232.7 x 142.0 x 4.0 9.16 x 5.59 x 0.157  |
| 501316591  | FM4790MP   | STEEL       | -----    | 42 | INT TH    | 150.9 x 102.5 x 2.5 5.94 x 4.04 x 0.098  |
| 501316592  | FM4786MP   | STEEL       | -----    | 42 | INT TH    | 167.8 x 102.5 x 2.5 6.61 x 4.04 x 0.098  |
| 680900050  | FM1801     | BRONZE      | WAFFLE   | 76 | EXT TH    | 164.1 x 103.1 x 2.8 6.46 x 4.06 x 0.11   |
| 680900060  | FM1220MP   | STEEL       | -----    | 40 | INT TH    | 152.4 x 82.3 x 1.6 6.0 x 3.24 x 0.063    |
| 4462305080 | FM3948MP   | STEEL       | -----    | 67 | (70)EX TH | 191.0 x 130.0 x 2.5 7.52 x 5.12 x 0.098  |
| 4462305081 | FM3946MP   | STEEL       | -----    | 67 | (70)EX TH | 191.0 x 130.0 x 3.0 7.52 x 5.12 x 0.118  |
| 4472320103 | FM6896MP   | STEEL       | -----    | 81 | EXT TH    | 243.6 x 152.1 x 2.0 9.59 x 5.99 x 0.079  |
| 4472320104 | FM4686MP   | STEEL       | -----    | 81 | EXT TH    | 243.6 x 152.1 x 2.5 9.59 x 5.99 x 0.098  |
| 4472320105 | FM6120-3.0 | STEEL       | -----    | 81 | EXT TH    | 243.5 x 153.0 x 3.0 9.59 x 6.02 x 0.118  |

| REPLACES<br>OEM PT.NO. | FMC<br>PART NO. | MATERIAL  | GROOVE<br>DETAILS | TEETH/<br>TANGS | SIZE MM   |       |   | SIZE INCH |   |     |       |   |      |   |       |
|------------------------|-----------------|-----------|-------------------|-----------------|-----------|-------|---|-----------|---|-----|-------|---|------|---|-------|
| 4474308082             | FM3610MP        | STEEL     | -----             | 91              | EXT TH    | 355.0 | x | 217.0     | x | 4.5 | 13.98 | x | 8.54 | x | 0.177 |
| 4474308083             | FM3612MP        | STEEL     | -----             | 91              | EXT TH    | 355.0 | x | 217.0     | x | 5.0 | 13.98 | x | 8.54 | x | 0.197 |
| 4474308084             | FM3614MP        | STEEL     | -----             | 91              | EXT TH    | 355.0 | x | 217.0     | x | 5.5 | 13.98 | x | 8.54 | x | 0.217 |
| 4642308330             | FM3592MP        | STEEL     | -----             | 29              | INT TH    | 131.1 | x | 85.1      | x | 1.5 | 5.16  | x | 3.35 | x | 0.059 |
| 4642308331             | FM3596MP        | STEEL     | -----             | 29              | INT TH    | 131.1 | x | 85.1      | x | 2.5 | 5.16  | x | 3.35 | x | 0.098 |
| 4642308332             | FM3594MP        | STEEL     | -----             | 29              | INT TH    | 131.1 | x | 85.1      | x | 2.0 | 5.16  | x | 3.35 | x | 0.079 |
| 4644308329             | FM3602MP        | STEEL     | -----             | 35              | INT TH    | 170.9 | x | 102.9     | x | 2.0 | 6.73  | x | 4.05 | x | 0.079 |
| 4644308330             | FM3604MP        | STEEL     | -----             | 35              | INT TH    | 170.9 | x | 102.9     | x | 2.5 | 6.73  | x | 4.05 | x | 0.098 |
| 11AB-00120             | FM4736MP        | STEEL     | -----             | 8               | EXT LG    | 134.5 | x | 81.0      | x | 1.8 | 5.3   | x | 3.19 | x | 0.071 |
| 11AB-00270             | FM7071          | PAPER     | 2 PASS            | 41              | INT TH    | 125.0 | x | 68.6      | x | 2.7 | 4.92  | x | 2.7  | x | 0.106 |
| 11AB-00280             | FM7074MP        | STEEL     | -----             | 50              | EXT TH    | 128.9 | x | 81.0      | x | 1.8 | 5.07  | x | 3.19 | x | 0.071 |
| 11AB-00410             | FM7492MP        | END PLATE | STEPPED           | 50              | EXT TH    | 129.0 | x | 81.0      | x | 6.2 | 5.08  | x | 3.19 | x | 0.294 |
| 11BB-00200             | FM3373          | PAPER     | 2 PASS            | 36              | INT TH    | 134.0 | x | 87.8      | x | 2.3 | 5.28  | x | 3.46 | x | 0.093 |
| 21AA-00190             | FM7848MP        | STEEL     | -----             | 6               | EXT LG    | 222.0 | x | 116.0     | x | 2.5 | 8.74  | x | 0.24 | x | 0.098 |
| 21AA-00210             | FM7845          | PAPER     | 2 PASS            | 22              | INT TH    | 186.0 | x | 53.3      | x | 3.2 | 7.32  | x | 2.1  | x | 0.126 |
| 21AB-00351             | FM6900MP        | STEEL     | -----             | 8               | EXT LG    | 258.0 | x | 167.0     | x | 2.5 | 10.16 | x | 6.57 | x | 0.098 |
| 21AB-00360             | FM6897          | PAPER     | 2 PASS            | 47              | INT TH    | 234.0 | x | 91.0      | x | 3.5 | 9.21  | x | 3.58 | x | 0.136 |
| 21DB-10070             | FM7721          | CARBON PA | WAFFLE            | 13              | INT TH    | 155.0 | x | 26.8      | x | 3.5 | 6.1   | x | 1.06 | x | 0.138 |
| 81F6-31130             | FM3724MP        | STEEL     | -----             | 8               | EXT LG    | 152.6 | x | 87.0      | x | 2.0 | 6.0   | x | 3.43 | x | 0.079 |
| 81F6-31140             | FM2135          | PAPER     | 2 PASS            | 38              | INT TH    | 133.6 | x | 77.0      | x | 2.8 | 5.26  | x | 3.03 | x | 0.11  |
| 81F7-34180             | FM2061          | PAPER     | WAFFLE            | 41              | INT TH    | 125.0 | x | 68.6      | x | 2.6 | 4.92  | x | 2.7  | x | 0.102 |
| 81F7-34190             | FM1844MP        | STEEL     | -----             | 8               | EXT LG    | 134.4 | x | 81.0      | x | 1.6 | 5.29  | x | 3.19 | x | 0.063 |
| DI0830A3-3WT           | FM7226MP        | STEEL     | -----             | 3               | EXT SL    | 247.0 | x | 162.0     | x | 3.4 | 9.72  | x | 6.38 | x | 0.134 |
| DI0840A3-3WT           | FM7223          | PAPER     | WAFFLE            | 24              | INT TH    | 228.5 | x | 60.0      | x | 3.2 | 9.0   | x | 2.36 | x | 0.126 |
| DCT156C1-00            | FM7352MP        | STEEL     | -----             | 6               | EXT LG    | 149.9 | x | 99.0      | x | 4.0 | 5.9   | x | 3.9  | x | 0.157 |
| DCT157C1-00            | FM7354MP        | STEEL     | -----             | 6               | EXT LG    | 149.9 | x | 99.0      | x | 2.0 | 5.9   | x | 3.9  | x | 0.079 |
| MS23TM0028A3           | FM7071          | PAPER     | 2 PASS            | 41              | INT TH    | 125.0 | x | 68.6      | x | 2.7 | 4.92  | x | 2.7  | x | 0.106 |
| XKAH-00086             | FM3393          | ELASTOMER | RADIAL            | 9               | INT LG    | 180.0 | x | 124.0     | x | 3.5 | 7.09  | x | 4.88 | x | 0.138 |
| XKAH-00087             | FM3400MP        | STEEL     | -----             | 6               | EXT LG    | 188.0 | x | 155.0     | x | 2.0 | 7.4   | x | 6.1  | x | 0.079 |
| XKAH-00399             | FM3389          | ELASTOMER | RADIAL            | 9               | INT LG    | 192.0 | x | 140.5     | x | 3.5 | 7.56  | x | 5.53 | x | 0.138 |
| XKAH-00401             | FM3392MP        | STEEL     | -----             | 6               | EXT LG    | 200.0 | x | 158.0     | x | 2.0 | 7.87  | x | 6.22 | x | 0.079 |
| XKAY-00297             | FM8307          | ELASTOMER | RADIAL            | 43              | INT TH    | 134.0 | x | 107.5     | x | 3.0 | 5.28  | x | 4.23 | x | 0.118 |
| XKAY-00298             | FM8310MP        | STEEL     | -----             | 8               | EXT LG    | 145.0 | x | 115.0     | x | 1.7 | 5.71  | x | 4.53 | x | 0.065 |
| XKAY-00465             | FM3927          | ELASTOMER | RADIAL            | 30              | (38)IN TH | 178.0 | x | 148.0     | x | 3.6 | 7.01  | x | 5.83 | x | 0.142 |
| XKAY-00466             | FM3930MP        | STEEL     | -----             | 4               | EXT LG    | 190.0 | x | 159.0     | x | 4.0 | 7.48  | x | 6.26 | x | 0.157 |
| XKAY-00537             | FM7903          | ELASTOMER | RADIAL            | 56              | INT TH    | 168.2 | x | 140.0     | x | 2.8 | 6.62  | x | 5.51 | x | 0.11  |
| XKAY-00538             | FM7906MP        | STEEL     | -----             | 16              | EXT LG    | 182.0 | x | 148.0     | x | 1.5 | 7.17  | x | 5.83 | x | 0.059 |
| XKBQ-00105             | FM2991          | PAPER     | 3 PASS            | 57              | INT TH    | 360.0 | x | 237.0     | x | 4.5 | 14.17 | x | 9.33 | x | 0.177 |
| XKBQ-00106             | FM8786MP        | STEEL     | -----             | 75              | EXT TH    | 383.0 | x | 253.0     | x | 3.0 | 15.08 | x | 9.96 | x | 0.118 |
| XKBQ-00107             | FM4020MP        | STEEL     | -----             | 75              | EXT TH    | 383.0 | x | 253.0     | x | 3.3 | 15.08 | x | 9.96 | x | 0.128 |
| XKBQ-00108             | FM8784MP        | STEEL     | -----             | 75              | EXT TH    | 383.0 | x | 253.0     | x | 3.5 | 15.08 | x | 9.96 | x | 0.138 |
| XKBQ-00109             | FM4022MP        | STEEL     | -----             | 75              | EXT TH    | 383.0 | x | 253.0     | x | 3.8 | 15.08 | x | 9.96 | x | 0.148 |
| XKBQ-00235             | FM2995          | PAPER     | 2 PASS            | 54              | INT TH    | 325.0 | x | 224.0     | x | 4.5 | 12.8  | x | 8.82 | x | 0.177 |
| XKBQ-00236             | FM7908MP        | STEEL     | -----             | 75              | EXT TH    | 345.0 | x | 243.0     | x | 3.0 | 13.58 | x | 9.57 | x | 0.118 |
| XKBQ-00237             | FM4026MP        | STEEL     | -----             | 75              | EXT TH    | 345.0 | x | 243.0     | x | 3.3 | 13.58 | x | 9.57 | x | 0.128 |
| XKBQ-00238             | FM7910MP        | STEEL     | -----             | 75              | EXT TH    | 345.0 | x | 243.0     | x | 3.5 | 13.58 | x | 9.57 | x | 0.138 |
| XKBQ-00239             | FM4028MP        | STEEL     | -----             | 75              | EXT TH    | 345.0 | x | 243.0     | x | 3.8 | 13.58 | x | 9.57 | x | 0.148 |
| XKBQ-00286             | FM2995          | PAPER     | 2 PASS            | 54              | INT TH    | 325.0 | x | 224.0     | x | 4.5 | 12.8  | x | 8.82 | x | 0.177 |

| REPLACES<br>OEM PT.NO. | FMC<br>PART NO. | MATERIAL  | GROOVE<br>DETAILS | TEETH/<br>TANGS | SIZE MM |       |   | SIZE INCH |   |     |       |   |      |   |       |
|------------------------|-----------------|-----------|-------------------|-----------------|---------|-------|---|-----------|---|-----|-------|---|------|---|-------|
| XKBQ-00349             | FM5567          | PAPER     | 2 PASS            | 41              | INT TH  | 250.0 | x | 170.0     | x | 4.5 | 9.84  | x | 6.69 | x | 0.177 |
| XKBQ-00372             | FM3636MP        | STEEL     | -----             | 75              | EXT TH  | 345.0 | x | 243.0     | x | 5.0 | 13.58 | x | 9.57 | x | 0.197 |
| XKBQ-00373             | FM3636MP        | STEEL     | -----             | 75              | EXT TH  | 345.0 | x | 243.0     | x | 5.0 | 13.58 | x | 9.57 | x | 0.197 |
| XKBQ-00436             | FM5570MP        | STEEL     | -----             | 77              | EXT TH  | 274.0 | x | 182.0     | x | 4.0 | 10.79 | x | 7.17 | x | 0.157 |
| XKBQ-00437             | FM5570-4.25     | STEEL     | -----             | 77              | EXT TH  | 274.0 | x | 182.0     | x | 4.3 | 10.79 | x | 7.17 | x | 0.167 |
| XKBQ-00439             | FM5567          | PAPER     | 2 PASS            | 41              | INT TH  | 250.0 | x | 170.0     | x | 4.5 | 9.84  | x | 6.69 | x | 0.177 |
| XKBT-00270             | FM3650MP        | STEEL     | -----             | 54              | EXT TH  | 139.2 | x | 98.6      | x | 3.0 | 5.48  | x | 3.88 | x | 0.118 |
| XKBT-00271             | FM2829          | PAPER     | 2 PASS            | 45              | INT TH  | 133.1 | x | 92.7      | x | 2.1 | 5.24  | x | 3.65 | x | 0.083 |
| XKBT-00409             | FM7226MP        | STEEL     | -----             | 3               | EXT SL  | 247.0 | x | 162.0     | x | 3.4 | 9.72  | x | 6.38 | x | 0.134 |
| XKBT-00410             | FM7223          | PAPER     | WAFFLE            | 24              | INT TH  | 228.5 | x | 60.0      | x | 3.2 | 9.0   | x | 2.36 | x | 0.126 |
| XKBT-00520             | FM7226MP        | STEEL     | -----             | 3               | EXT SL  | 247.0 | x | 162.0     | x | 3.4 | 9.72  | x | 6.38 | x | 0.134 |
| XKBT-00563             | FM6549          | PAPER     | 2 PASS            | 47              | INT TH  | 220.0 | x | 90.5      | x | 4.0 | 8.66  | x | 3.56 | x | 0.157 |
| XKBT-00564             | FM7246MP        | STEEL     | -----             | 3               | EXT SL  | 235.0 | x | 153.0     | x | 2.5 | 9.25  | x | 6.02 | x | 0.098 |
| XKBT-00580             | FM7352MP        | STEEL     | -----             | 6               | EXT LG  | 149.9 | x | 99.0      | x | 4.0 | 5.9   | x | 3.9  | x | 0.157 |
| XKBT-00581             | FM7354MP        | STEEL     | -----             | 6               | EXT LG  | 149.9 | x | 99.0      | x | 2.0 | 5.9   | x | 3.9  | x | 0.079 |
| XKBT-00642             | FM6549          | PAPER     | 2 PASS            | 47              | INT TH  | 220.0 | x | 90.5      | x | 4.0 | 8.66  | x | 3.56 | x | 0.157 |
| XKBT-00643             | FM7246MP        | STEEL     | -----             | 3               | EXT SL  | 235.0 | x | 153.0     | x | 2.5 | 9.25  | x | 6.02 | x | 0.098 |
| XKBT-00823             | FM2829          | PAPER     | 2 PASS            | 45              | INT TH  | 133.1 | x | 92.7      | x | 2.1 | 5.24  | x | 3.65 | x | 0.083 |
| XKBT-00824             | FM7354MP        | STEEL     | -----             | 6               | EXT LG  | 149.9 | x | 99.0      | x | 2.0 | 5.9   | x | 3.9  | x | 0.079 |
| XKCF-00060             | FM7071          | PAPER     | 2 PASS            | 41              | INT TH  | 125.0 | x | 68.6      | x | 2.7 | 4.92  | x | 2.7  | x | 0.106 |
| XKCF-00061             | FM7074MP        | STEEL     | -----             | 50              | EXT TH  | 128.9 | x | 81.0      | x | 1.8 | 5.07  | x | 3.19 | x | 0.071 |
| XKCF-00083             | FM7492MP        | END PLATE | STEPPED           | 50              | EXT TH  | 129.0 | x | 81.0      | x | 6.2 | 5.08  | x | 3.19 | x | 0.294 |
| XKCF-00137             | FM6900MP        | STEEL     | -----             | 8               | EXT LG  | 258.0 | x | 167.0     | x | 2.5 | 10.16 | x | 6.57 | x | 0.098 |
| XKCF-00138             | FM6897          | PAPER     | 2 PASS            | 47              | INT TH  | 234.0 | x | 91.0      | x | 3.5 | 9.21  | x | 3.58 | x | 0.136 |
| XKCF-00172             | FM7848MP        | STEEL     | -----             | 6               | EXT LG  | 222.0 | x | 116.0     | x | 2.5 | 8.74  | x | 0.24 | x | 0.098 |
| XKCF-00174             | FM7845          | PAPER     | 2 PASS            | 22              | INT TH  | 186.0 | x | 53.3      | x | 3.2 | 7.32  | x | 2.1  | x | 0.126 |
| XKCF-00454             | FM7358MP        | STEEL     | -----             | 4               | EXT LG  | 134.0 | x | 95.2      | x | 1.8 | 5.28  | x | 3.75 | x | 0.071 |
| XKCF-00455             | FM7355          | PAPER     | 2 PASS            | 45              | INT TH  | 124.1 | x | 90.2      | x | 2.7 | 4.88  | x | 3.55 | x | 0.106 |
| XKCF-00487             | FM7724MP        | STEEL     | -----             | 4               | EXT LG  | 188.2 | x | 124.1     | x | 2.5 | 7.41  | x | 4.89 | x | 0.098 |
| XKCF-00489             | FM7721          | CARBON PA | WAFFLE            | 13              | INT TH  | 155.0 | x | 26.8      | x | 3.5 | 6.1   | x | 1.06 | x | 0.138 |
| XKCF-00527             | FM9268MP        | STEEL     | -----             | 4               | EXT LG  | 176.0 | x | 110.0     | x | 2.0 | 6.93  | x | 4.33 | x | 0.079 |
| XKCF-00528             | FM9265          | PAPER     | WAFFLE            | 39              | INT TH  | 132.0 | x | 97.6      | x | 2.5 | 5.2   | x | 3.84 | x | 0.096 |
| XKCF-00590             | FM7208MP        | STEEL     | -----             | 4               | EXT LG  | 209.1 | x | 146.0     | x | 2.5 | 8.23  | x | 5.74 | x | 0.098 |
| XKCF-00591             | FM7205          | CARBON PA | WAF/RAD           | 13              | INT TH  | 178.0 | x | 30.0      | x | 3.5 | 7.01  | x | 1.18 | x | 0.138 |
| XKCF-00644             | FM6897          | PAPER     | 2 PASS            | 47              | INT TH  | 234.0 | x | 91.0      | x | 3.5 | 9.21  | x | 3.58 | x | 0.136 |
| ZGAQ-00137             | FM3612MP        | STEEL     | -----             | 91              | EXT TH  | 355.0 | x | 217.0     | x | 5.0 | 13.98 | x | 8.54 | x | 0.197 |
| ZGAQ-00138             | FM3614MP        | STEEL     | -----             | 91              | EXT TH  | 355.0 | x | 217.0     | x | 5.5 | 13.98 | x | 8.54 | x | 0.217 |
| ZGAQ-00139             | FM2815          | PAPER     | 4 PASS            | 42              | INT TH  | 340.0 | x | 206.0     | x | 5.5 | 13.39 | x | 8.11 | x | 0.217 |
| ZGAQ-00320             | FM4286MP        | STEEL     | -----             | 45              | INT TH  | 185.0 | x | 132.7     | x | 3.5 | 7.28  | x | 5.22 | x | 0.138 |
| ZGAQ-00324             | FM6781          | CARBON PA | RADIAL            | 64              | EXT TH  | 196.0 | x | 142.0     | x | 2.6 | 7.72  | x | 5.59 | x | 0.1   |
| ZGAQ-00326             | FM4298MP        | STEEL     | -----             | 45              | INT TH  | 170.0 | x | 132.7     | x | 2.5 | 6.69  | x | 5.22 | x | 0.098 |
| ZGAQ-00330             | FM4783          | CARBON PA | RADIAL            | 34              | EXT TH  | 177.4 | x | 111.5     | x | 2.5 | 6.98  | x | 4.39 | x | 0.098 |
| ZGAQ-00821             | FM4786MP        | STEEL     | -----             | 42              | INT TH  | 167.8 | x | 102.5     | x | 2.5 | 6.61  | x | 4.04 | x | 0.098 |
| ZGAQ-00852             | FM4783          | CARBON PA | RADIAL            | 34              | EXT TH  | 177.4 | x | 111.5     | x | 2.5 | 6.98  | x | 4.39 | x | 0.098 |
| ZGAQ-00853             | FM4790MP        | STEEL     | -----             | 42              | INT TH  | 150.9 | x | 102.5     | x | 2.5 | 5.94  | x | 4.04 | x | 0.098 |
| ZGAQ-00982             | FM4650MP        | STEEL     | -----             | 24              | EXT TH  | 108.2 | x | 76.2      | x | 1.2 | 4.26  | x | 3.0  | x | 0.045 |
| ZGAQ-00994             | FM7038MP        | STEEL     | HARD/BLACK        | 64              | EXT TH  | 196.4 | x | 140.0     | x | 2.9 | 7.73  | x | 5.51 | x | 0.114 |

| REPLACES<br>OEM PT.NO. | FMC<br>PART NO. | MATERIAL    | GROOVE<br>DETAILS | TEETH/<br>TANGS | SIZE MM   |       |   | SIZE INCH |   |     |       |   |       |   |       |
|------------------------|-----------------|-------------|-------------------|-----------------|-----------|-------|---|-----------|---|-----|-------|---|-------|---|-------|
| ZGAQ-00995             | FM7038-3.5      | STEEL       | HARD/BLACK        | 64              | EXT TH    | 196.4 | x | 140.0     | x | 3.5 | 7.73  | x | 5.51  | x | 0.138 |
| ZGAQ-01001             | FM4933          | BRONZE      | WAF/WAG           | 45              | INT TH    | 187.0 | x | 132.6     | x | 3.0 | 7.36  | x | 5.22  | x | 0.118 |
| ZGAQ-01296             | FM6120-3.0      | STEEL       | -----             | 81              | EXT TH    | 243.5 | x | 153.0     | x | 3.0 | 9.59  | x | 6.02  | x | 0.118 |
| ZGAQ-01297             | FM4686MP        | STEEL       | -----             | 81              | EXT TH    | 243.6 | x | 152.1     | x | 2.5 | 9.59  | x | 5.99  | x | 0.098 |
| ZGAQ-01298             | FM6896MP        | STEEL       | -----             | 81              | EXT TH    | 243.6 | x | 152.1     | x | 2.0 | 9.59  | x | 5.99  | x | 0.079 |
| ZGAQ-01299             | FM4089          | PAPER       | 3 PASS            | 48              | INT TH    | 232.7 | x | 142.0     | x | 4.0 | 9.16  | x | 5.59  | x | 0.157 |
| ZGAQ-01374             | FM7038MP        | STEEL       | HARD/BLACK        | 64              | EXT TH    | 196.4 | x | 140.0     | x | 2.9 | 7.73  | x | 5.51  | x | 0.114 |
| ZGAQ-01508             | FM4785          | PAPER/PLAIN | RADIAL            | 34              | EXT TH    | 177.4 | x | 111.5     | x | 1.9 | 6.98  | x | 4.39  | x | 0.075 |
| ZGAQ-01509             | FM4787          | CARBON PA   | RADIAL            | 44              | EXT TH    | 158.8 | x | 111.5     | x | 2.5 | 6.25  | x | 4.39  | x | 0.098 |
| ZGAQ-01675             | FM4286MP        | STEEL       | -----             | 45              | INT TH    | 185.0 | x | 132.7     | x | 3.5 | 7.28  | x | 5.22  | x | 0.138 |
| ZGAQ-01944             | FM6113          | PAPER/PLAIN | RADIAL            | 27              | EXT TH    | 137.0 | x | 93.7      | x | 1.9 | 5.39  | x | 3.69  | x | 0.073 |
| ZGAQ-01945             | FM6111          | CARBON PA   | RADIAL            | 27              | EXT TH    | 137.0 | x | 93.7      | x | 2.5 | 5.39  | x | 3.69  | x | 0.098 |
| ZGAQ-02026             | FM8188MP        | STEEL       | HARDENED          | 45              | EXT TH    | 111.2 | x | 84.2      | x | 1.4 | 4.38  | x | 3.31  | x | 0.055 |
| ZGAQ-02220             | FM6715          | CARBON PA   | WAFFLE            | 8               | EXT LG    | 262.7 | x | 155.0     | x | 4.5 | 10.34 | x | 6.1   | x | 0.177 |
| ZGAQ-02221             | FM7132-2.5      | STEEL       | -----             | 36              | (48)IN TH | 236.0 | x | 144.2     | x | 2.5 | 9.29  | x | 5.68  | x | 0.098 |
| ZGAQ-02222             | FM7132-2.0      | STEEL       | -----             | 36              | (48)IN TH | 236.0 | x | 144.2     | x | 2.0 | 9.29  | x | 5.68  | x | 0.079 |
| ZGAQ-02223             | FM7132-3.0      | STEEL       | -----             | 36              | (48)IN TH | 236.0 | x | 144.2     | x | 3.0 | 9.29  | x | 5.68  | x | 0.118 |
| ZGAQ-02330             | FM7132-2.5      | STEEL       | -----             | 36              | (48)IN TH | 236.0 | x | 144.2     | x | 2.5 | 9.29  | x | 5.68  | x | 0.098 |
| ZGAQ-02331             | FM7132-2.0      | STEEL       | -----             | 36              | (48)IN TH | 236.0 | x | 144.2     | x | 2.0 | 9.29  | x | 5.68  | x | 0.079 |
| ZGAQ-02332             | FM7132-3.0      | STEEL       | -----             | 36              | (48)IN TH | 236.0 | x | 144.2     | x | 3.0 | 9.29  | x | 5.68  | x | 0.118 |
| ZGAQ-02452             | FM7126-2.9      | STEEL       | HARDENED          | 4               | EXT LG    | 164.8 | x | 82.4      | x | 2.9 | 6.49  | x | 4.24  | x | 0.114 |
| ZGAQ-02453             | FM7126-3.0      | STEEL       | HARDENED          | 4               | EXT LG    | 164.8 | x | 82.4      | x | 3.0 | 6.49  | x | 4.24  | x | 0.118 |
| ZGAQ-02454             | FM7126-3.1      | STEEL       | HARDENED          | 4               | EXT LG    | 164.8 | x | 82.4      | x | 3.1 | 6.49  | x | 4.24  | x | 0.122 |
| ZGAQ-02463             | FM4449          | MOLYBDENUM  | SPR/WAG           | 26              | INT TH    | 147.8 | x | 75.4      | x | 3.0 | 5.82  | x | 2.97  | x | 0.118 |
| ZGAQ-02511             | FM4183          | PAPER       | WAF/WAG           | 64              | INT TH    | 345.0 | x | 252.1     | x | 4.7 | 13.58 | x | 9.93  | x | 0.185 |
| ZGAQ-02512             | FM4186MP        | STEEL       | -----             | 20              | EXT LG    | 372.5 | x | 262.5     | x | 4.0 | 14.67 | x | 10.33 | x | 0.157 |
| ZGAQ-02513             | FM5572MP        | STEEL       | -----             | 20              | EXT LG    | 372.5 | x | 262.5     | x | 2.0 | 14.67 | x | 10.33 | x | 0.079 |
| ZGAQ-02692             | FM5250-3.0      | STEEL       | HARDENED          | 4               | EXT LG    | 189.8 | x | 92.1      | x | 3.0 | 7.47  | x | 3.63  | x | 0.118 |
| ZGAQ-02693             | FM5250-2.7      | STEEL       | HARDENED          | 4               | EXT LG    | 189.8 | x | 92.1      | x | 2.7 | 7.47  | x | 3.63  | x | 0.106 |
| ZGAQ-02694             | FM5250-2.9      | STEEL       | HARDENED          | 4               | EXT LG    | 189.8 | x | 92.1      | x | 2.9 | 7.47  | x | 3.63  | x | 0.114 |
| ZGAQ-02695             | FM5250-3.1      | STEEL       | HARDENED          | 4               | EXT LG    | 189.8 | x | 92.1      | x | 3.1 | 7.47  | x | 3.63  | x | 0.122 |
| ZGAQ-02696             | FM5250-3.2      | STEEL       | HARDENED          | 4               | EXT LG    | 189.8 | x | 92.1      | x | 3.2 | 7.47  | x | 3.63  | x | 0.126 |
| ZGAQ-02697             | FM5250-3.3      | STEEL       | HARDENED          | 4               | EXT LG    | 189.8 | x | 92.1      | x | 3.3 | 7.47  | x | 3.63  | x | 0.13  |
| ZGAQ-02698             | FM5247          | MOLYBDENUM  | SPR/WAG           | 40              | INT TH    | 172.0 | x | 84.1      | x | 3.0 | 6.77  | x | 3.31  | x | 0.118 |
| ZGAQ-02779             | FM6417          | BRONZE      | WAF/WAG           | 64              | INT TH    | 345.0 | x | 252.0     | x | 3.8 | 13.58 | x | 9.92  | x | 0.15  |
| ZGAQ-02780             | FM6454MP        | STEEL       | HARDENED          | 20              | EXT LG    | 374.0 | x | 262.0     | x | 2.4 | 14.72 | x | 10.31 | x | 0.094 |
| ZGAQ-02926             | FM8429          | CARBON PA   | WAFFLE            | 8               | EXT LG    | 240.0 | x | 140.0     | x | 4.5 | 9.45  | x | 5.51  | x | 0.177 |
| ZGAQ-02927             | FM8432-2.5      | STEEL       | -----             | 31              | (40)IN TH | 208.0 | x | 119.0     | x | 2.5 | 8.19  | x | 4.69  | x | 0.098 |
| ZGAQ-02928             | FM8432-2.0      | STEEL       | -----             | 31              | (40)IN TH | 208.0 | x | 119.0     | x | 2.0 | 8.19  | x | 4.69  | x | 0.079 |
| ZGAQ-02929             | FM8432-3.0      | STEEL       | -----             | 31              | (40)IN TH | 208.0 | x | 119.0     | x | 3.0 | 8.19  | x | 4.69  | x | 0.118 |
| ZGAQ-03009             | FM7677          | CARBON PA   | WAFFLE            | 34              | INT TH    | 109.7 | x | 68.4      | x | 1.6 | 4.32  | x | 2.69  | x | 0.063 |
| ZGAQ-03011             | FM7680MP        | STEEL       | DISHED            | 30              | EXT TH    | 119.8 | x | 75.3      | x | 1.8 | 4.72  | x | 2.96  | x | 0.071 |
| ZGAQ-03062             | FM5967          | PAPER       | WAFFLE            | 40              | INT TH    | 119.7 | x | 79.0      | x | 1.6 | 4.71  | x | 3.11  | x | 0.063 |
| ZGAQ-03063             | FM5970MP        | STEEL       | -----             | 30              | EXT TH    | 130.9 | x | 86.8      | x | 1.8 | 5.15  | x | 3.42  | x | 0.071 |
| ZGAQ-03447             | FM7526MP        | STEEL       | -----             | 4               | EXT LG    | 251.0 | x | 153.6     | x | 4.0 | 9.88  | x | 6.05  | x | 0.157 |
| ZGAQ-03448             | FM7521          | PAPER       | 3 PASS            | 48              | INT TH    | 233.0 | x | 141.5     | x | 5.5 | 9.17  | x | 5.57  | x | 0.217 |
| ZGAQ-03450             | FM7523          | PAPER       | 3 PASS            | 20              | INT TH    | 233.0 | x | 59.5      | x | 5.5 | 9.17  | x | 2.34  | x | 0.217 |
| ZTAJ-00022             | FM1801          | BRONZE      | WAFFLE            | 76              | EXT TH    | 164.1 | x | 103.1     | x | 2.8 | 6.46  | x | 4.06  | x | 0.11  |

| REPLACES<br>OEM PT.NO. | FMC<br>PART NO. | MATERIAL         | GROOVE<br>DETAILS | TEETH/<br>TANGS | SIZE MM |       |   | SIZE INCH |   |     |      |   |      |   |       |
|------------------------|-----------------|------------------|-------------------|-----------------|---------|-------|---|-----------|---|-----|------|---|------|---|-------|
| ZTAJ-00023             | FM1220MP        | STEEL            | -----             | 40              | INT TH  | 152.4 | x | 82.3      | x | 1.6 | 6.0  | x | 3.24 | x | 0.063 |
| ZTAM-00090             | FM4625          | PAPER            | SUNBURST          | 16              | INT TH  | 201.0 | x | 40.5      | x | 4.9 | 7.91 | x | 1.59 | x | 0.192 |
| ZTAM-00099             | FM4606MP        | STEEL            | -----             | 3               | EXT LG  | 216.9 | x | 144.0     | x | 2.7 | 8.54 | x | 5.67 | x | 0.106 |
| ZTAM-00219             | FM2344MP        | STEEL            | -----             | 6               | EXT LG  | 220.0 | x | 145.5     | x | 2.7 | 8.66 | x | 5.73 | x | 0.105 |
| ZTAM-00968             | FM2341          | BRONZE           | SUNBURST          | 16              | INT TH  | 202.9 | x | 40.4      | x | 4.9 | 7.99 | x | 1.59 | x | 0.192 |
| ZTAM-00143             | FM5407          | MOLYBDENUM       | RADIAL            | 34              | INT TH  | 109.8 | x | 66.0      | x | 1.3 | 4.32 | x | 2.6  | x | 0.052 |
| ZTAM-00145             | FM6922MP        | STEEL            | HARDENED          | 4               | EXT LG  | 122.6 | x | 72.2      | x | 1.8 | 4.83 | x | 2.84 | x | 0.071 |
| ZTAM-00146             | FM5409          | MOLYBDENUM/STEEL | RADIAL            | 34              | INT TH  | 109.8 | x | 66.0      | x | 2.9 | 4.32 | x | 2.6  | x | 0.112 |
| ZTAM-01082             | FM9379          |                  |                   |                 |         |       |   |           |   |     |      |   |      |   |       |
| ZTAM-01222             | FM6127          | PAPER            | WAFFLE            | 24              | INT TH  | 253.0 | x | 69.0      | x | 6.1 | 9.96 | x | 2.72 | x | 0.24  |

| REPLACES<br>OEM PT.NO.         | FMC<br>PART NO. | MATERIAL         | GROOVE<br>DETAILS | TEETH/<br>TANGS | SIZE MM    |       |   | SIZE INCH |   |      |       |   |       |   |       |
|--------------------------------|-----------------|------------------|-------------------|-----------------|------------|-------|---|-----------|---|------|-------|---|-------|---|-------|
| <b>INNOCENTI</b>               |                 |                  |                   |                 |            |       |   |           |   |      |       |   |       |   |       |
| 3707370                        | FM2831          | BRONZE           | SPR/RAD           | 124             | INT TH     | 482.6 | x | 388.6     | x | 5.6  | 19.0  | x | 15.3  | x | 0.219 |
| 3300414                        | FM4901          | BRONZE           | SPR/RAD           | 84              | INT TH     | 540.0 | x | 420.4     | x | 4.7  | 21.26 | x | 16.55 | x | 0.185 |
| 432801085                      | FM4904MP        | STEEL            | -----             | 110             | EXT TH     | 569.0 | x | 444.2     | x | 4.7  | 22.4  | x | 17.49 | x | 0.185 |
| <b>INTERNATIONAL (DRESSER)</b> |                 |                  |                   |                 |            |       |   |           |   |      |       |   |       |   |       |
| 72330                          | FM1935          | BRONZE           | 240 RADIAL        | 45              | INT TH     | 133.1 | x | 92.7      | x | 1.6  | 5.24  | x | 3.65  | x | 0.063 |
| 72372                          | FM1933          | BRONZE           | RADIAL            | 59              | INT TH     | 190.8 | x | 147.3     | x | 3.0  | 7.51  | x | 5.8   | x | 0.118 |
| 100049A1                       | FM2896MP        | STEEL            | -----             | 142             | EXT TH     | 455.0 | x | 342.0     | x | 4.0  | 17.91 | x | 13.46 | x | 0.157 |
| 100050A1                       | FM2893          | PAPER            | 3 PASS            | 104             | INT TH     | 437.9 | x | 325.1     | x | 5.3  | 17.24 | x | 12.8  | x | 0.209 |
| 103310A1                       | FM1216MP        | STEEL            | -----             | 60              | EXT TH     | 154.2 | x | 113.8     | x | 1.8  | 6.07  | x | 4.48  | x | 0.07  |
| 103310A1                       | FM4486MP        | STEEL            | HARDENED          | 60              | EXT TH     | 154.2 | x | 113.8     | x | 1.8  | 6.07  | x | 4.48  | x | 0.07  |
| 114622C1                       | FM3807          | YELLOW PA        | 2 PASS            | 15              | INT TH     | 259.1 | x | 51.1      | x | 7.6  | 10.2  | x | 2.01  | x | 0.3   |
| 114622C1                       | FM1765          | RED PAPER        | 2 PASS            | 15              | INT TH     | 259.1 | x | 51.1      | x | 7.6  | 10.2  | x | 2.01  | x | 0.3   |
| 119336A1                       | FM4451          | MOLYBDENUM       | SPR/WAG           | 46              | (50)INT TH | 117.5 | x | 62.6      | x | 2.6  | 4.63  | x | 2.46  | x | 0.102 |
| 119430A1                       | FM3608MP        | STEEL            | -----             | 88              | (91)EX TH  | 293.0 | x | 185.0     | x | 4.5  | 11.54 | x | 7.28  | x | 0.177 |
| 119431A1                       | FM3606MP        | STEEL            | -----             | 88              | (91)EX TH  | 293.0 | x | 185.0     | x | 4.0  | 11.54 | x | 7.28  | x | 0.157 |
| 119433A1                       | FM2811          | PAPER            | 4 PASS            | 34              | INT TH     | 277.0 | x | 167.0     | x | 4.5  | 10.91 | x | 6.57  | x | 0.177 |
| 119228A1                       | FM7500MP        | END PLATE        | STEPPED           | 35              | EXT TH     | 177.3 | x | 109.4     | x | 10.9 | 6.98  | x | 4.3   | x | 0.429 |
| 119229A1                       | FM7500MP        | END PLATE        | STEPPED           | 35              | EXT TH     | 177.3 | x | 109.4     | x | 10.9 | 6.98  | x | 4.3   | x | 0.429 |
| 120486C1                       | FM7396MP        | STEEL            | -----             | 5               | EXT LG     | 350.0 | x | 192.0     | x | 2.8  | 13.78 | x | 7.56  | x | 0.108 |
| 120488C1                       | FM7393          | PAPER            | WAFFLE            | 18              | INT TH     | 305.0 | x | 108.0     | x | 4.9  | 12.0  | x | 4.25  | x | 0.193 |
| 120488C2                       | FM7393          | PAPER            | WAFFLE            | 18              | INT TH     | 305.0 | x | 108.0     | x | 4.9  | 12.0  | x | 4.25  | x | 0.193 |
| 125504H1                       | FM2273          | BRONZE           | SPR/WAG           | 32              | INT TH     | 146.1 | x | 78.5      | x | 1.6  | 5.75  | x | 3.09  | x | 0.063 |
| 125505H1                       | FM2276MP        | STEEL            | -----             | 12              | EXT SL     | 174.5 | x | 85.6      | x | 1.8  | 6.87  | x | 3.37  | x | 0.071 |
| 129529H1                       | FM2330MP        | STEEL            | -----             | 12              | EXT SL     | 174.5 | x | 85.6      | x | 1.8  | 6.87  | x | 3.37  | x | 0.071 |
| 146055A1                       | FM7231          | PAPER            | 2 PASS            | 14              | INT TH     | 338.0 | x | 66.4      | x | 4.6  | 13.31 | x | 2.61  | x | 0.181 |
| 146057A1                       | FM7234MP        | STEEL            | -----             | 3               | EXT SL     | 376.0 | x | 260.0     | x | 4.5  | 14.8  | x | 10.24 | x | 0.177 |
| 148903A1                       | FM5407          | MOLYBDENUM       | RADIAL            | 34              | INT TH     | 109.8 | x | 66.0      | x | 1.3  | 4.32  | x | 2.6   | x | 0.052 |
| 148905A1                       | FM6922MP        | STEEL            | HARDENED          | 4               | EXT LG     | 122.6 | x | 72.2      | x | 1.8  | 4.83  | x | 2.84  | x | 0.071 |
| 148906A1                       | FM5409          | MOLYBDENUM/STEEL | RADIAL            | 34              | INT TH     | 109.8 | x | 66.0      | x | 2.9  | 4.32  | x | 2.6   | x | 0.112 |
| 148962A1                       | FM4625          | PAPER            | SUNBURST          | 16              | INT TH     | 201.0 | x | 40.5      | x | 4.9  | 7.91  | x | 1.59  | x | 0.192 |
| 148963A1                       | FM2344MP        | STEEL            | -----             | 6               | EXT LG     | 220.0 | x | 145.5     | x | 2.7  | 8.66  | x | 5.73  | x | 0.105 |
| 149584                         | FM1279          | PAPER            | 2 PASS            | 52              | INT TH     | 148.6 | x | 107.7     | x | 1.8  | 5.85  | x | 4.24  | x | 0.07  |
| 149585                         | FM1216MP        | STEEL            | -----             | 60              | EXT TH     | 154.2 | x | 113.8     | x | 1.8  | 6.07  | x | 4.48  | x | 0.07  |
| 156320H1                       | FM3020MP        | STEEL            | -----             | 8               | EXT LG     | 210.8 | x | 152.4     | x | 2.1  | 8.3   | x | 6.0   | x | 0.083 |
| 157021H1                       | FM1687          | BRONZE           | SUNBURST          | 34              | INT TH     | 198.1 | x | 140.5     | x | 2.5  | 7.8   | x | 5.53  | x | 0.098 |
| 181158A1                       | FM2825          | BRONZE           | SUNBURST          | 45              | INT TH     | 133.0 | x | 93.0      | x | 1.8  | 5.24  | x | 3.66  | x | 0.069 |
| 181159A1                       | FM2828MP        | STEEL            | -----             | 6               | EXT LG     | 151.0 | x | 98.0      | x | 2.5  | 5.94  | x | 3.86  | x | 0.098 |
| 187109H1                       | FM1361          | BRONZE           | SUNBURST          | 45              | INT TH     | 133.1 | x | 92.7      | x | 1.6  | 5.24  | x | 3.65  | x | 0.063 |
| 188828H1                       | OBSOLETE        | BRONZE           | SPIRAL            | 4               | INT TH     | 243.8 | x | 204.2     | x | 6.3  | 9.6   | x | 8.04  | x | 0.247 |
| 190462A1                       | FM2823          | PAPER            | 2 PASS            | 36              | INT TH     | 223.0 | x | 71.0      | x | 4.9  | 8.78  | x | 2.8   | x | 0.191 |
| 195409H1                       | FM1245          | BRONZE           | SUNBURST          | 73              | INT TH     | 371.3 | x | 303.0     | x | 5.2  | 14.62 | x | 11.93 | x | 0.205 |
| 196073A1                       | FM2823          | PAPER            | 2 PASS            | 36              | INT TH     | 223.0 | x | 71.0      | x | 4.9  | 8.78  | x | 2.8   | x | 0.191 |
| 196625H1                       | FM3347          | BRONZE           | SUNBURST          | 72              | INT TH     | 246.1 | x | 178.1     | x | 4.9  | 9.69  | x | 7.01  | x | 0.193 |
| 196680H1                       | FM5827          | BRONZE           | SUNBURST          | 52              | INT TH     | 292.1 | x | 213.9     | x | 5.1  | 11.5  | x | 8.42  | x | 0.201 |
| 215737H1                       | FM2332MP        | STEEL            | -----             | 12              | EXT SL     | 174.5 | x | 112.8     | x | 1.8  | 6.87  | x | 4.44  | x | 0.071 |
| 219179H1                       | FM2295          | BRONZE           | SPR/WAG           | 34              | INT TH     | 146.1 | x | 104.9     | x | 1.7  | 5.75  | x | 4.13  | x | 0.066 |

| REPLACES<br>OEM PT.NO. | FMC<br>PART NO. | MATERIAL    | GROOVE<br>DETAILS | TEETH/<br>TANGS | SIZE MM   |       |   | SIZE INCH |   |      |       |   |       |   |       |
|------------------------|-----------------|-------------|-------------------|-----------------|-----------|-------|---|-----------|---|------|-------|---|-------|---|-------|
| 220025H1               | FM1690MP        | STEEL       | -----             | 12              | EXT SL    | 174.5 | x | 112.8     | x | 1.8  | 6.87  | x | 4.44  | x | 0.071 |
| 237017A1               | FM3351          | GRAPHITE    | SUNBURST          | 36              | INT TH    | 272.0 | x | 71.1      | x | 4.9  | 10.71 | x | 2.8   | x | 0.193 |
| 237021A1               | FM2823          | PAPER       | 2 PASS            | 36              | INT TH    | 223.0 | x | 71.0      | x | 4.9  | 8.78  | x | 2.8   | x | 0.191 |
| ALTERNATIVE            | FM7337          | PAPER       | 2 PASS            | 36              | INT TH    | 223.0 | x | 71.0      | x | 4.9  | 8.78  | x | 2.8   | x | 0.191 |
| 237022A1               | FM3414MP        | END PLATE   | -----             | 32              | (64)EX TH | 230.0 | x | 152.5     | x | 10.8 | 9.06  | x | 6.0   | x | 0.397 |
| 237023A1               | FM3906MP        | END PLATE   | -----             | 32              | (64)EX TH | 230.0 | x | 152.5     | x | 9.0  | 9.06  | x | 6.0   | x | 0.354 |
| 237024A1               | FM3908MP        | END PLATE   | -----             | 32              | (64)EX TH | 230.0 | x | 152.5     | x | 9.0  | 9.06  | x | 6.0   | x | 0.354 |
| 245297A1               | FM3261          | PAPER       | 2 PASS            | 40              | INT TH    | 127.1 | x | 82.2      | x | 2.5  | 5.0   | x | 3.24  | x | 0.98  |
| 259492C1               | FM3347          | BRONZE      | SUNBURST          | 72              | INT TH    | 246.1 | x | 178.1     | x | 4.9  | 9.69  | x | 7.01  | x | 0.193 |
| 291578A1               | FM4995          | PAPER       | 2 PASS/PLAIN      | 54              | EXT TH    | 139.0 | x | 99.0      | x | 2.0  | 5.47  | x | 3.9   | x | 0.077 |
| 291579A1               | FM4993          | PAPER       | 2 PASS            | 54              | EXT TH    | 139.0 | x | 99.0      | x | 2.7  | 5.47  | x | 3.9   | x | 0.104 |
| 291580A1               | FM4998MP        | STEEL       | -----             | 45              | INT TH    | 133.0 | x | 92.7      | x | 2.0  | 5.24  | x | 3.65  | x | 0.079 |
| 308029A1               | FM3910MP        | END PLATE   | -----             | 64              | EXT TH    | 230.0 | x | 151.0     | x | 9.0  | 9.06  | x | 5.94  | x | 0.354 |
| 308030A1               | FM3912MP        | END PLATE   | -----             | 64              | EXT TH    | 230.0 | x | 152.5     | x | 5.0  | 9.06  | x | 6.0   | x | 0.197 |
| 310519A1               | FM3904MP        | END PLATE   | -----             | 6               | EXT LG    | 146.0 | x | 97.0      | x | 10.2 | 5.75  | x | 3.82  | x | 0.402 |
| 313807R1               | FM1294MP        | STEEL       | -----             | 30              | (90)EX TH | 387.4 | x | 321.8     | x | 5.0  | 15.25 | x | 12.67 | x | 0.197 |
| 324240R1               | FM1361          | BRONZE      | SUNBURST          | 45              | INT TH    | 133.1 | x | 92.7      | x | 1.6  | 5.24  | x | 3.65  | x | 0.063 |
| 324241R1               | FM1262MP        | STEEL       | -----             | 8               | EXT LG    | 142.5 | x | 99.1      | x | 1.6  | 5.61  | x | 3.9   | x | 0.063 |
| 324452R1               | FM4528MP        | STEEL       | RUBBER PINS       | 8               | EXT LG    | 244.0 | x | 173.0     | x | 3.2  | 9.61  | x | 6.81  | x | 0.126 |
| 324452R1               | FM4896MP        | STEEL       | -----             | 8               | EXT LG    | 244.0 | x | 173.0     | x | 3.2  | 9.61  | x | 6.81  | x | 0.126 |
| 324456R1               | FM4525OE        | BRONZE      | SUNBURST          | 39              | INT TH    | 228.9 | x | 162.0     | x | 2.9  | 9.01  | x | 6.38  | x | 0.112 |
| 324483R1               | FM3020MP        | STEEL       | -----             | 8               | EXT LG    | 210.8 | x | 152.4     | x | 2.1  | 8.3   | x | 6.0   | x | 0.083 |
| 327173R1               | FM2379          | BRONZE      | SUNBURST          | 29              | INT TH    | 168.1 | x | 119.1     | x | 2.5  | 6.62  | x | 4.69  | x | 0.1   |
| 327174R1               | FM2382MP        | STEEL       | -----             | 8               | EXT LG    | 180.1 | x | 129.5     | x | 2.1  | 7.09  | x | 5.1   | x | 0.083 |
| 331387A1               | FM4787          | CARBON PA   | RADIAL            | 44              | EXT TH    | 158.8 | x | 111.5     | x | 2.5  | 6.25  | x | 4.39  | x | 0.098 |
| 331388A1               | FM4790MP        | STEEL       | -----             | 42              | INT TH    | 150.9 | x | 102.5     | x | 2.5  | 5.94  | x | 4.04  | x | 0.098 |
| 331893A1               | FM4785          | PAPER/PLAIN | RADIAL            | 34              | EXT TH    | 177.4 | x | 111.5     | x | 1.9  | 6.98  | x | 4.39  | x | 0.075 |
| 331894A1               | FM4783          | CARBON PA   | RADIAL            | 34              | EXT TH    | 177.4 | x | 111.5     | x | 2.5  | 6.98  | x | 4.39  | x | 0.098 |
| 331895A1               | FM4786MP        | STEEL       | -----             | 42              | INT TH    | 167.8 | x | 102.5     | x | 2.5  | 6.61  | x | 4.04  | x | 0.098 |
| 331896A1               | FM4789          | PAPER/PLAIN | RADIAL            | 44              | EXT TH    | 158.8 | x | 111.5     | x | 1.9  | 6.25  | x | 4.39  | x | 0.075 |
| 331897A1               | FM4787          | CARBON PA   | RADIAL            | 44              | EXT TH    | 158.8 | x | 111.5     | x | 2.5  | 6.25  | x | 4.39  | x | 0.098 |
| 335165A1               | FM6781          | CARBON PA   | RADIAL            | 64              | EXT TH    | 196.0 | x | 142.0     | x | 2.6  | 7.72  | x | 5.59  | x | 0.1   |
| 335167A1               | FM6783          | CARBON PA   | RADIAL/PLAIN      | 64              | EXT TH    | 196.0 | x | 142.0     | x | 2.0  | 7.72  | x | 5.59  | x | 0.079 |
| 336319R1               | FM2705B         | BRONZE      | SUNBURST          | 93              | EXT TH    | 239.8 | x | 171.6     | x | 3.5  | 9.44  | x | 6.76  | x | 0.138 |
| 336822R1               | FM2395B         | BRONZE      | SUNBURST          | 100             | EXT TH    | 214.6 | x | 151.6     | x | 3.1  | 8.45  | x | 5.97  | x | 0.122 |
| 336823R1               | FM2398MP        | STEEL       | DISHED            | 56              | INT TH    | 203.2 | x | 138.4     | x | 2.3  | 8.0   | x | 5.45  | x | 0.091 |
| 348956A1               | FM3093KIT       | OBSOLETE    | BRAKE KIT         |                 |           |       |   |           |   |      |       |   |       |   |       |
| 351175A1               | FM4243          | PAPER       | 3 PASS            | 16              | INT TH    | 301.0 | x | 54.0      | x | 6.3  | 11.85 | x | 2.13  | x | 0.248 |
| 351175A2               | FM6853          | CARBON PA   | 3 PASS            | 16              | INT TH    | 301.0 | x | 54.0      | x | 6.3  | 11.85 | x | 2.13  | x | 0.248 |
| 357534A1               | FM3659          | PAPER       | 4 PASS/WAG        | 104             | INT TH    | 437.9 | x | 325.1     | x | 5.0  | 17.24 | x | 12.8  | x | 0.197 |
| 381489R3               | FM8320MP        | STEEL       | -----             | 6               | EXT LG    | 145.8 | x | 103.2     | x | 1.8  | 5.74  | x | 4.06  | x | 0.069 |
| 381490R4               | FM8317          | CARBON PA   | WAFFLE            | 51              | INT TH    | 134.8 | x | 95.0      | x | 2.5  | 5.31  | x | 3.74  | x | 0.098 |
| 384322A1               | FM4183          | PAPER       | WAF/WAG           | 64              | INT TH    | 345.0 | x | 252.1     | x | 4.7  | 13.58 | x | 9.93  | x | 0.185 |
| 384323A1               | FM4186MP        | STEEL       | -----             | 20              | EXT LG    | 372.5 | x | 262.5     | x | 4.0  | 14.67 | x | 10.33 | x | 0.157 |
| 399734R1               | FM1765          | RED PAPER   | 2 PASS            | 15              | INT TH    | 259.1 | x | 51.1      | x | 7.6  | 10.2  | x | 2.01  | x | 0.3   |
| 399734R1               | FM3807          | YELLOW PA   | 2 PASS            | 15              | INT TH    | 259.1 | x | 51.1      | x | 7.6  | 10.2  | x | 2.01  | x | 0.3   |
| 399736R3               | FM1836MP        | STEEL       | -----             | 3               | INT LG    | 258.8 | x | 185.7     | x | 6.7  | 10.19 | x | 7.31  | x | 0.262 |
| 452160A1               | FM3095          | GRAPHITE    | SUNBURST          | 13              | INT TH    | 215.0 | x | 36.5      | x | 10.0 | 8.46  | x | 1.44  | x | 0.394 |

| REPLACES<br>OEM PT.NO. | FMC<br>PART NO. | MATERIAL | GROOVE<br>DETAILS | TEETH/<br>TANGS | SIZE MM |       |   | SIZE INCH |   |     |       |   |       |   |       |
|------------------------|-----------------|----------|-------------------|-----------------|---------|-------|---|-----------|---|-----|-------|---|-------|---|-------|
| 473032C1               | OBSOLETE        | PAPER    | 2 PASS            | 62              | INT TH  | 319.0 | x | 259.3     | x | 3.8 | 12.56 | x | 10.21 | x | 0.148 |
| 533804R1               | FM3143          | PAPER    | 2 PASS            | 45              | INT TH  | 125.5 | x | 93.2      | x | 2.1 | 4.94  | x | 3.67  | x | 0.082 |
| 615559C1               | FM1965          | BRONZE   | SPR/WAG           | 60              | INT TH  | 253.7 | x | 187.5     | x | 3.9 | 9.99  | x | 7.38  | x | 0.153 |
| 615840C1               | FM1243          | GRAPHITE | SUNBURST          | 73              | INT TH  | 371.3 | x | 303.0     | x | 5.2 | 14.62 | x | 11.93 | x | 0.205 |
| 615911C1               | FM1177          | GRAPHITE | SUNBURST          | 72              | INT TH  | 371.3 | x | 303.0     | x | 5.2 | 14.62 | x | 11.93 | x | 0.205 |
| 619200C1               | FM4525OE        | BRONZE   | SUNBURST          | 39              | INT TH  | 228.9 | x | 162.0     | x | 2.9 | 9.01  | x | 6.38  | x | 0.112 |
| 625615C1               | FM1179          | GRAPHITE | SUNBURST          | 60              | INT TH  | 253.7 | x | 187.5     | x | 3.9 | 9.99  | x | 7.38  | x | 0.153 |
| 630047C1               | FM2704MP        | STEEL    | -----             | 64              | INT TH  | 228.6 | x | 158.7     | x | 2.6 | 9.0   | x | 6.25  | x | 0.102 |
| 630281C1               | FM2398MP        | STEEL    | DISHED            | 56              | INT TH  | 203.2 | x | 138.7     | x | 2.3 | 8.0   | x | 5.46  | x | 0.091 |
| 630515C2               | FM1305OE        | BRONZE   | RADIAL            | 52              | INT TH  | 148.6 | x | 107.7     | x | 2.6 | 5.85  | x | 4.24  | x | 0.102 |
| 630516C2               | FM1216MP        | STEEL    | -----             | 60              | EXT TH  | 154.2 | x | 113.8     | x | 1.8 | 6.07  | x | 4.48  | x | 0.07  |
| 634490C2               | FM3691          | PAPER    | WAFFLE            | 100             | EXT TH  | 214.6 | x | 151.4     | x | 3.2 | 8.45  | x | 5.96  | x | 0.125 |
| 634534C1               | FM1359          | BRONZE   | SPIRAL            | 45              | INT TH  | 133.1 | x | 92.7      | x | 1.6 | 5.24  | x | 3.65  | x | 0.063 |
| 634535C1               | FM2379          | BRONZE   | SUNBURST          | 29              | INT TH  | 168.1 | x | 119.3     | x | 2.5 | 6.62  | x | 4.7   | x | 0.1   |
| 634536C1               | FM1687          | BRONZE   | SUNBURST          | 34              | INT TH  | 198.1 | x | 140.5     | x | 2.5 | 7.8   | x | 5.53  | x | 0.098 |
| 634558C1               | FM3687          | PAPER    | WAFFLE            | 93              | EXT TH  | 239.8 | x | 171.6     | x | 3.6 | 9.44  | x | 6.76  | x | 0.142 |
| 654594C3               | FM1249          | GRAPHITE | SUNBURST          | 34              | INT TH  | 198.1 | x | 140.5     | x | 2.5 | 7.8   | x | 5.53  | x | 0.098 |
| 658354C2               | FM1251          | GRAPHITE | SUNBURST          | 45              | INT TH  | 266.7 | x | 187.2     | x | 2.8 | 10.5  | x | 7.37  | x | 0.11  |
| 658451C1               | FM5884MP        | STEEL    | -----             | 8               | EXT LG  | 330.0 | x | 240.0     | x | 2.4 | 12.99 | x | 9.45  | x | 0.093 |
| 659592C1               | FM1744MP        | STEEL    | -----             | 54              | EXT TH  | 276.0 | x | 200.7     | x | 2.3 | 10.87 | x | 7.9   | x | 0.09  |
| 659611C1               | FM1742MP        | STEEL    | -----             | 41              | EXT TH  | 210.1 | x | 152.4     | x | 2.1 | 8.27  | x | 6.0   | x | 0.083 |
| 659746C3               | FM1255          | GRAPHITE | SUNBURST          | 52              | INT TH  | 420.9 | x | 323.9     | x | 4.3 | 16.57 | x | 12.75 | x | 0.169 |
| 659761C2               | FM1253          | GRAPHITE | SUNBURST          | 36              | INT TH  | 316.0 | x | 222.3     | x | 4.3 | 12.44 | x | 8.75  | x | 0.168 |
| 659819C1               | FM2268MP        | STEEL    | -----             | 6               | EXT LG  | 438.2 | x | 342.9     | x | 2.3 | 17.25 | x | 13.5  | x | 0.09  |
| 702874C1               | FM1687          | BRONZE   | SUNBURST          | 34              | INT TH  | 198.1 | x | 140.5     | x | 2.5 | 7.8   | x | 5.53  | x | 0.098 |
| 702959C1               | FM1361          | BRONZE   | SUNBURST          | 45              | INT TH  | 133.1 | x | 92.7      | x | 1.6 | 5.24  | x | 3.65  | x | 0.063 |
| 702962C1               | FM2379          | BRONZE   | SUNBURST          | 29              | INT TH  | 168.1 | x | 119.1     | x | 2.5 | 6.62  | x | 4.69  | x | 0.1   |
| 705105C2               | FM4525OE        | BRONZE   | SUNBURST          | 39              | INT TH  | 228.9 | x | 162.0     | x | 2.9 | 9.01  | x | 6.38  | x | 0.112 |
| 709527C1               | FM5954MP        | STEEL    | -----             | 6               | EXT LG  | 198.2 | x | 133.4     | x | 2.3 | 7.8   | x | 5.25  | x | 0.091 |
| 709804C1               | FM2268MP        | STEEL    | -----             | 6               | EXT LG  | 438.2 | x | 342.9     | x | 2.3 | 17.25 | x | 13.5  | x | 0.09  |
| 709807C91              | FM2268MP        | STEEL    | -----             | 6               | EXT LG  | 438.2 | x | 342.9     | x | 2.3 | 17.25 | x | 13.5  | x | 0.09  |
| 709808C91              | FM5892MP        | STEEL    | RUBBER PINS       | 8               | EXT LG  | 329.0 | x | 240.0     | x | 2.4 | 12.95 | x | 9.45  | x | 0.093 |
| 716929C2               | FM5965          | PAPER    | 3 PASS            | 36              | INT TH  | 316.0 | x | 222.5     | x | 4.3 | 12.44 | x | 8.76  | x | 0.168 |
| 730858C1               | FM6801          | CARBON   | SUNBURST          | 39              | INT TH  | 228.1 | x | 161.8     | x | 2.8 | 8.98  | x | 6.37  | x | 0.112 |
| 730963C1               | FM6799          | OBSOLETE | SUNBURST          | 36              | INT TH  | 316.0 | x | 222.5     | x | 2.8 | 12.44 | x | 8.76  | x | 0.112 |
| 886934C1               | FM2295          | BRONZE   | SPR/WAG           | 34              | INT TH  | 146.1 | x | 104.9     | x | 1.7 | 5.75  | x | 4.13  | x | 0.066 |
| 886938C1               | FM2273          | BRONZE   | SPR/WAG           | 32              | INT TH  | 146.1 | x | 78.5      | x | 1.6 | 5.75  | x | 3.09  | x | 0.063 |
| 892887C1               | FM2332MP        | STEEL    | -----             | 12              | EXT SL  | 174.5 | x | 112.8     | x | 1.8 | 6.87  | x | 4.44  | x | 0.071 |
| 893515C1               | FM1690MP        | STEEL    | -----             | 12              | EXT SL  | 174.5 | x | 112.8     | x | 1.8 | 6.87  | x | 4.44  | x | 0.071 |
| 894083H1               | FM0545          | BRONZE   | SPR/WAG           | 32              | INT TH  | 145.0 | x | 78.5      | x | 2.0 | 5.7   | x | 3.09  | x | 0.079 |
| 922539C1               | FM1560MP        | STEEL    | -----             | 85              | EXT TH  | 181.6 | x | 85.6      | x | 1.7 | 7.15  | x | 3.37  | x | 0.066 |
| 922541C1               | FM1565          | PAPER    | 2 PASS            | 32              | INT TH  | 167.6 | x | 78.7      | x | 1.8 | 6.6   | x | 3.1   | x | 0.07  |
| 922549C1               | FM1562MP        | STEEL    | -----             | 85              | EXT TH  | 181.4 | x | 112.8     | x | 1.7 | 7.14  | x | 4.44  | x | 0.066 |
| 922551C1               | FM1567          | PAPER    | 2 PASS            | 34              | INT TH  | 167.6 | x | 104.6     | x | 1.8 | 6.6   | x | 4.12  | x | 0.07  |
| 922913C1               | FM2068MP        | STEEL    | -----             |                 | SPRING  | 179.8 | x | 173.5     | x | 0.4 | 7.08  | x | 6.83  | x | 0.016 |
| 924109C1               | FM4528MP        | STEEL    | RUBBER PINS       | 8               | EXT LG  | 244.0 | x | 173.0     | x | 3.2 | 9.61  | x | 6.81  | x | 0.126 |
| 970696C2               | FM2332MP        | STEEL    | -----             | 12              | EXT SL  | 174.5 | x | 112.8     | x | 1.8 | 6.87  | x | 4.44  | x | 0.071 |



| REPLACES<br>OEM PT.NO. | FMC<br>PART NO. | MATERIAL   | GROOVE<br>DETAILS | TEETH/<br>TANGS | SIZE MM     |       |   | SIZE INCH |   |     |       |   |      |   |       |
|------------------------|-----------------|------------|-------------------|-----------------|-------------|-------|---|-----------|---|-----|-------|---|------|---|-------|
| 970697C2               | FM1690MP        | STEEL      | -----             | 12              | EXT SL      | 174.5 | x | 112.8     | x | 1.8 | 6.87  | x | 4.44 | x | 0.071 |
| 984439C1               | FM1836MP        | STEEL      | -----             | 3               | INT LG      | 258.8 | x | 185.7     | x | 6.7 | 10.19 | x | 7.31 | x | 0.262 |
| 1201474H1              | FM4449          | MOLYBDENUM | SPR/WAG           | 26              | INT TH      | 147.8 | x | 75.4      | x | 3.0 | 5.82  | x | 2.97 | x | 0.118 |
| 1027256C1              | FM1765          | RED PAPER  | 2 PASS            | 15              | INT TH      | 259.1 | x | 51.1      | x | 7.6 | 10.2  | x | 2.01 | x | 0.3   |
| 1027256C1              | FM3807          | YELLOW PA  | 2 PASS            | 15              | INT TH      | 259.1 | x | 51.1      | x | 7.6 | 10.2  | x | 2.01 | x | 0.3   |
| 1202654H1              | FM2279          | BRONZE     | SUNBURST          | 35              | EXT TH      | 177.5 | x | 109.0     | x | 2.0 | 6.99  | x | 4.29 | x | 0.079 |
| 1202655H1              | FM3600MP        | STEEL      | -----             | 35              | INT TH      | 170.9 | x | 102.9     | x | 1.5 | 6.73  | x | 4.05 | x | 0.059 |
| 1202656H1              | FM3602MP        | STEEL      | -----             | 35              | INT TH      | 170.9 | x | 102.9     | x | 2.0 | 6.73  | x | 4.05 | x | 0.079 |
| 1202657H1              | FM3604MP        | STEEL      | -----             | 35              | INT TH      | 170.9 | x | 102.9     | x | 2.5 | 6.73  | x | 4.05 | x | 0.098 |
| 1202681H1              | FM2277          | BRONZE     | SUNBURST          | 27              | EXT TH      | 137.4 | x | 90.9      | x | 2.0 | 5.41  | x | 3.58 | x | 0.079 |
| 1202682H1              | FM3594MP        | STEEL      | -----             | 29              | INT TH      | 131.1 | x | 85.1      | x | 2.0 | 5.16  | x | 3.35 | x | 0.079 |
| 1202683H1              | FM3596MP        | STEEL      | -----             | 29              | INT TH      | 131.1 | x | 85.1      | x | 2.5 | 5.16  | x | 3.35 | x | 0.098 |
| 1202684H1              | FM3592MP        | STEEL      | -----             | 29              | INT TH      | 131.1 | x | 85.1      | x | 1.5 | 5.16  | x | 3.35 | x | 0.059 |
| 1209800H1              | FM5457          | PAPER      | 2 PASS            | 29              | INT TH      | 183.9 | x | 119.4     | x | 3.9 | 7.24  | x | 4.7  | x | 0.154 |
| 1222489C1              | FM5886MP        | STEEL      | RUBBER PINS       | 6               | EXT LG      | 437.0 | x | 343.0     | x | 2.4 | 17.2  | x | 13.5 | x | 0.093 |
| 1222489H91             | FM2268MP        | STEEL      | -----             | 6               | EXT LG      | 438.2 | x | 342.9     | x | 2.3 | 17.25 | x | 13.5 | x | 0.09  |
| FM1251 MATE            | FM4532MP        | STEEL      | -----             | 8               | EXT LG      | 282.0 | x | 200.0     | x | 3.2 | 11.1  | x | 7.87 | x | 0.126 |
| 1222490H91             | FM7584MP        | STEEL      | RUBBER PINS       | 8               | EXT LG      | 283.4 | x | 200.2     | x | 2.4 | 11.16 | x | 7.88 | x | 0.093 |
| 1230637H1              | FM4647          | BRONZE     | SPR/RAD           | 34              | INT TH      | 100.0 | x | 68.2      | x | 1.6 | 3.94  | x | 2.69 | x | 0.061 |
| 1244205H1              | FM3813          | TAN PAPER  | 2 PASS            | 50              | (52) INT TH | 148.6 | x | 107.7     | x | 2.7 | 5.85  | x | 4.24 | x | 0.108 |
| 1244205H1              | FM5295          | GREEN PA   | 2 PASS            | 50              | (52) INT TH | 148.6 | x | 107.7     | x | 2.7 | 5.85  | x | 4.24 | x | 0.108 |
| 1260006H1              | FM5888MP        | STEEL      | HARDENED          | 8               | EXT LG      | 247.0 | x | 173.0     | x | 2.4 | 9.72  | x | 6.81 | x | 0.093 |
| 1260007H1              | FM5890MP        | STEEL      | HARDENED          | 8               | EXT LG      | 247.0 | x | 173.0     | x | 2.4 | 9.72  | x | 6.81 | x | 0.093 |
| 1263329H1              | FM3353          | BRONZE     | SUN/WAG           | 35              | INT TH      | 179.0 | x | 103.0     | x | 3.5 | 7.05  | x | 4.05 | x | 0.138 |
| 1263329H1              | FM3575          | PAPER      | 3 PASS            | 35              | INT TH      | 179.0 | x | 103.0     | x | 3.5 | 7.05  | x | 4.05 | x | 0.138 |
| 1276803H1              | FM3946MP        | STEEL      | -----             | 67              | (70)EX TH   | 191.0 | x | 130.0     | x | 3.0 | 7.52  | x | 5.12 | x | 0.118 |
| 1276804H1              | FM3948MP        | STEEL      | -----             | 67              | (70)EX TH   | 191.0 | x | 130.0     | x | 2.5 | 7.52  | x | 5.12 | x | 0.098 |
| 1276909H1              | FM7038MP        | STEEL      | HARD/BLACK        | 64              | EXT TH      | 196.4 | x | 140.0     | x | 2.9 | 7.73  | x | 5.51 | x | 0.114 |
| 1276912H1              | FM7038-3.5      | STEEL      | HARD/BLACK        | 64              | EXT TH      | 196.4 | x | 140.0     | x | 3.5 | 7.73  | x | 5.51 | x | 0.138 |
| 1276916H1              | FM4933          | BRONZE     | WAF/WAG           | 45              | INT TH      | 187.0 | x | 132.6     | x | 3.0 | 7.36  | x | 5.22 | x | 0.118 |
| 1285974C1              | FM8328MP        | STEEL      | -----             | 8               | EXT LG      | 244.0 | x | 173.0     | x | 2.3 | 9.61  | x | 8.81 | x | 0.091 |
| 1285975C2              | FM8325          | CARBON PA  | WAFFLE            | 39              | INT TH      | 228.0 | x | 162.0     | x | 2.9 | 8.98  | x | 6.38 | x | 0.114 |
| 1342285C1              | FM2841          | BRONZE     | SPR/RAD           | 19              | INT TH      | 203.2 | x | 57.2      | x | 4.7 | 8.0   | x | 2.25 | x | 0.185 |
| 1345726C1              | FM6295          | IRON       | 2 PASS            | 16              | INT TH      | 143.0 | x | 63.5      | x | 6.3 | 5.63  | x | 2.5  | x | 0.248 |
| 1997907C1              | FM8333          | PAPER      | WAFFLE            | 48              | INT TH      | 141.0 | x | 99.0      | x | 2.0 | 5.55  | x | 3.9  | x | 0.079 |
| 3135827R1              | FM6420MP        | STEEL      | -----             | 22              | INT TH      | 155.6 | x | 79.4      | x | 2.0 | 6.13  | x | 3.13 | x | 0.079 |
| 3136997R91             | FM3499          | BRONZE     | SPR/RAD           | 12              | EXT SL      | 181.5 | x | 120.3     | x | 2.5 | 7.15  | x | 4.74 | x | 0.098 |
| 3145546R91             | FM2389          | PAPER      | WAFFLE            | 10              | INT TH      | 226.7 | x | 48.3      | x | 8.9 | 8.92  | x | 1.9  | x | 0.35  |
| 3145546R92             | FM2389          | PAPER      | WAFFLE            | 10              | INT TH      | 226.7 | x | 48.3      | x | 8.9 | 8.92  | x | 1.9  | x | 0.35  |
| 3220450R91             | FM2391          | PAPER      | WAFFLE            | 10              | INT TH      | 255.4 | x | 48.3      | x | 8.9 | 10.05 | x | 1.9  | x | 0.35  |
| 3220450R92             | FM2391          | PAPER      | WAFFLE            | 10              | INT TH      | 255.4 | x | 48.3      | x | 8.9 | 10.05 | x | 1.9  | x | 0.35  |
| 3220450R94             | FM2391          | PAPER      | WAFFLE            | 10              | INT TH      | 255.4 | x | 48.3      | x | 8.9 | 10.05 | x | 1.9  | x | 0.35  |
| 3376410R1              | FM4650MP        | STEEL      | -----             | 24              | EXT TH      | 108.2 | x | 76.2      | x | 1.2 | 4.26  | x | 3.0  | x | 0.045 |
| 3380998H1              | FM3946MP        | STEEL      | -----             | 67              | (70)EX TH   | 191.0 | x | 130.0     | x | 3.0 | 7.52  | x | 5.12 | x | 0.118 |
| 3380999H1              | FM3575          | PAPER      | 3 PASS            | 35              | INT TH      | 179.0 | x | 103.0     | x | 3.5 | 7.05  | x | 4.05 | x | 0.138 |
| 3381148H91             | FM5250-3.3      | STEEL      | HARDENED          | 4               | EXT LG      | 289.8 | x | 92.1      | x | 3.3 | 7.47  | x | 3.63 | x | 0.13  |
| 3381439H91             | FM5247          | MOLYBDENUM | SPR/WAG           | 40              | INT TH      | 172.0 | x | 84.1      | x | 3.0 | 6.77  | x | 3.31 | x | 0.118 |

| REPLACES<br>OEM PT.NO. | FMC<br>PART NO. | MATERIAL  | GROOVE<br>DETAILS | TEETH/<br>TANGS | SIZE MM |       |   |       | SIZE INCH |     |      |   |      |   |       |
|------------------------|-----------------|-----------|-------------------|-----------------|---------|-------|---|-------|-----------|-----|------|---|------|---|-------|
| <b>IOCHPE MAXION</b>   |                 |           |                   |                 |         |       |   |       |           |     |      |   |      |   |       |
| 041053R1               | FM2971          | BRONZE    | WAFFLE            | 22              | INT TH  | 71.7  | x | 44.0  | x         | 2.8 | 2.82 | x | 1.73 | x | 0.11  |
| 041054R1               | FM3474MP        | STEEL     | -----             | 4               | EXT LG  | 85.0  | x | 49.2  | x         | 1.5 | 3.35 | x | 1.94 | x | 0.059 |
| 041055R1               | FM2969          | BRONZE    | WAFFLE            | 22              | INT TH  | 71.7  | x | 44.0  | x         | 1.6 | 2.82 | x | 1.73 | x | 0.063 |
| <b>ISEKI</b>           |                 |           |                   |                 |         |       |   |       |           |     |      |   |      |   |       |
| 1444-327-201-1         | FM6155          | PAPER     | 2 PASS            | 22              | INT TH  | 153.0 | x | 36.7  | x         | 3.4 | 6.02 | x | 1.44 | x | 0.134 |
| 1444-327-202-1         | FM6158MP        | STEEL     | -----             | 1               | EXT LG  | 158.0 | x | 90.0  | x         | 2.5 | 6.22 | x | 3.54 | x | 0.098 |
| 1513-310-201-0         | FM6159          | PAPER     | 2 PASS            | 25              | INT TH  | 183.0 | x | 41.7  | x         | 3.4 | 7.2  | x | 1.64 | x | 0.134 |
| 1513-310-202-0         | FM6162MP        | STEEL     | -----             | 1               | EXT LG  | 188.0 | x | 130.0 | x         | 2.5 | 7.4  | x | 5.12 | x | 0.098 |
| 1560-310-201-1         | FM6155          | PAPER     | 2 PASS            | 22              | INT TH  | 153.0 | x | 36.7  | x         | 3.4 | 6.02 | x | 1.44 | x | 0.134 |
| 1564-310-261-1         | FM6159          | PAPER     | 2 PASS            | 25              | INT TH  | 183.0 | x | 41.7  | x         | 3.4 | 7.2  | x | 1.64 | x | 0.134 |
| <b>ITOCHU</b>          |                 |           |                   |                 |         |       |   |       |           |     |      |   |      |   |       |
| 14705                  | FM2971          | BRONZE    | WAFFLE            | 22              | INT TH  | 71.7  | x | 44.0  | x         | 2.8 | 2.82 | x | 1.73 | x | 0.11  |
| 14706                  | FM3474MP        | STEEL     | -----             | 4               | EXT LG  | 85.0  | x | 49.2  | x         | 1.5 | 3.35 | x | 1.94 | x | 0.059 |
| 14707                  | FM2969          | BRONZE    | WAFFLE            | 22              | INT TH  | 71.7  | x | 44.0  | x         | 1.6 | 2.82 | x | 1.73 | x | 0.063 |
| <b>IVECO</b>           |                 |           |                   |                 |         |       |   |       |           |     |      |   |      |   |       |
| 42546599               | FM9354MP        | STEEL     | -----             | 8               | EXT LG  | 161.6 | x | 107.0 | x         | 1.8 | 6.36 | x | 4.21 | x | 0.071 |
| 42546600               | FM9351          | CARBON PA | 2 PASS            | 34              | INT TH  | 146.7 | x | 99.7  | x         | 2.1 | 5.78 | x | 3.93 | x | 0.083 |

| REPLACES OEM PT.NO. | FMC PART NO. | MATERIAL | GROOVE DETAILS | TEETH/TANGS | SIZE MM | SIZE INCH |
|---------------------|--------------|----------|----------------|-------------|---------|-----------|
|---------------------|--------------|----------|----------------|-------------|---------|-----------|

### JEFFREY

|           |          |          |        |    |        |                     |                     |
|-----------|----------|----------|--------|----|--------|---------------------|---------------------|
| 443901    | FM1206MP | OBSOLETE | -----  | 40 | INT TH | 295.1 x 198.1 x 4.8 | 11.62 x 7.8 x 0.189 |
| 446103    | FM1231   | OBSOLETE | SPRWAG | 60 | EXT TH | 308.6 x 215.9 x 5.7 | 12.15 x 8.5 x 0.224 |
| 1.59E+110 | FM1206MP | OBSOLETE | -----  | 40 | INT TH | 295.1 x 198.1 x 4.8 | 11.62 x 7.8 x 0.189 |
| 173E596   | FM1231   | OBSOLETE | SPRWAG | 60 | EXT TH | 308.6 x 215.9 x 5.7 | 12.15 x 8.5 x 0.224 |

### JLG / OMNIQUIP

|          |          |           |          |    |           |                      |                     |
|----------|----------|-----------|----------|----|-----------|----------------------|---------------------|
| ?        | FM7247   | GRAPHITE  | SUNBURST | 20 | INT TH    | 200.0 x 59.0 x 4.3   | 7.87 x 2.32 x 0.169 |
| ?        | FM7853   | OBSOLETE  | SUNBURST | 20 | INT TH    | 200.0 x 59.0 x 4.5   | 7.87 x 2.32 x 0.177 |
| ?        | FM7250MP | STEEL     | -----    | 5  | EXT LG    | 210.6 x 158.5 x 2.5  | 8.29 x 6.24 x 0.098 |
| 8033570  | FM2781   | GRAPHITE  | SUNBURST | 15 | INT TH    | 213.0 x 44.0 x 10.0  | 8.38 x 1.73 x 0.394 |
| 8035184  | FM2971   | BRONZE    | WAFFLE   | 22 | INT TH    | 71.7 x 44.0 x 2.8    | 2.82 x 1.73 x 0.11  |
| 8035185  | FM3474MP | STEEL     | -----    | 4  | EXT LG    | 85.0 x 49.2 x 1.5    | 3.35 x 1.94 x 0.059 |
| 8035186  | FM2969   | BRONZE    | WAFFLE   | 22 | INT TH    | 71.7 x 44.0 x 1.6    | 2.82 x 1.73 x 0.063 |
| 8035199  | FM2823   | PAPER     | 2 PASS   | 36 | INT TH    | 223.0 x 71.0 x 4.9   | 8.78 x 2.8 x 0.191  |
| 91474123 | FM2971   | BRONZE    | WAFFLE   | 22 | INT TH    | 71.7 x 44.0 x 2.8    | 2.82 x 1.73 x 0.11  |
| 91474124 | FM3474MP | STEEL     | -----    | 4  | EXT LG    | 85.0 x 49.2 x 1.5    | 3.35 x 1.94 x 0.059 |
| 91474139 | FM3414MP | END PLATE | -----    | 32 | (64)EX TH | 230.0 x 152.5 x 10.8 | 9.06 x 6.0 x 0.397  |
| 91474140 | FM2823   | PAPER     | 2 PASS   | 36 | INT TH    | 223.0 x 71.0 x 4.9   | 8.78 x 2.8 x 0.191  |
| 91474141 | FM3912MP | END PLATE | -----    | 64 | EXT TH    | 230.0 x 152.5 x 5.0  | 9.06 x 6.0 x 0.197  |
| 91474568 | FM4625   | PAPER     | SUNBURST | 16 | INT TH    | 201.0 x 40.5 x 4.9   | 7.91 x 1.59 x 0.192 |
| 91474569 | FM4606MP | STEEL     | -----    | 3  | EXT LG    | 216.9 x 144.0 x 2.7  | 8.54 x 5.67 x 0.106 |

### JOHN DEERE (ALSO SEE FUNK)

|          |        |        |          |    |        |                     |                      |
|----------|--------|--------|----------|----|--------|---------------------|----------------------|
| AL29645  | FM2403 | PAPER  | 3 PASS   | 12 | INT TH | 305.6 x 45.5 x 7.2  | 12.03 x 1.79 x 0.283 |
| AL30095  | FM2405 | PAPER  | 3 PASS   | 15 | INT TH | 306.0 x 57.6 x 10.1 | 12.03 x 2.27 x 0.402 |
| AL38234  | FM2403 | PAPER  | 3 PASS   | 12 | INT TH | 305.6 x 45.5 x 7.2  | 12.03 x 1.79 x 0.283 |
| AL38235  | FM2405 | PAPER  | 3 PASS   | 15 | INT TH | 306.0 x 57.6 x 10.1 | 12.03 x 2.27 x 0.402 |
| AL38236  | FM2407 | PAPER  | 3 PASS   | 12 | INT TH | 306.0 x 45.5 x 10.1 | 12.03 x 1.79 x 0.402 |
| AL38238  | FM3133 | PAPER  | 2 PASS   | 6  | INT LG | 191.9 x 152.3 x 2.3 | 7.56 x 6.0 x 0.091   |
| AL38239  | FM3707 | PAPER  | 2 PASS   | 45 | INT TH | 133.1 x 92.7 x 2.5  | 5.24 x 3.65 x 0.1    |
| AL38240  | FM1649 | PAPER  | 2 PASS   | 45 | INT TH | 133.1 x 92.7 x 1.6  | 5.24 x 3.65 x 0.063  |
| AL55075  | FM6225 | BRONZE | SUNBURST | 19 | INT TH | 110.0 x 28.0 x 6.0  | 4.33 x 1.1 x 0.236   |
| AL65871  | FM2975 | PAPER  | 3 PASS   | 15 | INT TH | 305.8 x 55.1 x 4.8  | 12.04 x 2.17 x 0.189 |
| AL65872  | FM2977 | PAPER  | 3 PASS   | 12 | INT TH | 305.8 x 42.9 x 4.8  | 12.04 x 1.69 x 0.189 |
| AL66796  | FM2977 | PAPER  | 3 PASS   | 12 | INT TH | 305.8 x 42.9 x 4.8  | 12.04 x 1.69 x 0.189 |
| AL66797  | FM2977 | PAPER  | 3 PASS   | 12 | INT TH | 305.8 x 42.9 x 4.8  | 12.04 x 1.69 x 0.189 |
| AL68096  | FM2407 | PAPER  | 3 PASS   | 12 | INT TH | 306.0 x 45.5 x 10.1 | 12.03 x 1.79 x 0.402 |
| AL68507  | FM2977 | PAPER  | 3 PASS   | 12 | INT TH | 305.8 x 42.9 x 4.8  | 12.04 x 1.69 x 0.189 |
| AL68508  | FM2977 | PAPER  | 3 PASS   | 12 | INT TH | 305.8 x 42.9 x 4.8  | 12.04 x 1.69 x 0.189 |
| AL69559  | FM6189 | BRONZE | SUNBURST | 45 | INT TH | 133.1 x 92.7 x 2.5  | 5.24 x 3.65 x 0.1    |
| AL69560  | FM6187 | BRONZE | SUNBURST | 45 | INT TH | 133.1 x 92.7 x 1.6  | 5.24 x 3.65 x 0.063  |
| AL75434  | FM2973 | PAPER  | 3 PASS   | 14 | INT TH | 313.0 x 43.4 x 4.8  | 12.32 x 1.71 x 0.189 |
| AL76887  | FM7631 | PAPER  | 3 PASS   | 14 | INT TH | 305.8 x 36.2 x 4.9  | 12.04 x 1.43 x 0.193 |
| AL111498 | FM2973 | PAPER  | 3 PASS   | 14 | INT TH | 313.0 x 43.4 x 4.8  | 12.32 x 1.71 x 0.189 |
| AL112982 | FM4115 | PAPER  | 3 PASS   | 14 | INT TH | 313.0 x 43.4 x 6.0  | 12.32 x 1.71 x 0.236 |
| AL159761 | FM2973 | PAPER  | 3 PASS   | 14 | INT TH | 313.0 x 43.4 x 4.8  | 12.32 x 1.71 x 0.189 |
| AL159762 | FM4115 | PAPER  | 3 PASS   | 14 | INT TH | 313.0 x 43.4 x 6.0  | 12.32 x 1.71 x 0.236 |

| REPLACES<br>OEM PT.NO. | FMC<br>PART NO. | MATERIAL   | GROOVE<br>DETAILS | TEETH/<br>TANGS | SIZE MM   |       |   | SIZE INCH |   |      |       |   |       |   |       |
|------------------------|-----------------|------------|-------------------|-----------------|-----------|-------|---|-----------|---|------|-------|---|-------|---|-------|
| AL160564               | FM5037          | PAPER      | HOLES             | 75              | (77)IN TH | 320.7 | x | 266.4     | x | 3.8  | 12.63 | x | 10.49 | x | 0.148 |
| AL160565               | FM5040MP        | STEEL      | -----             | 24              | (56)EX TH | 352.3 | x | 279.1     | x | 2.5  | 13.87 | x | 10.99 | x | 0.098 |
| AL160566               | FM5041          | PAPER      | 2 PASS/HARDEN     | 75              | (77)IN TH | 320.7 | x | 266.4     | x | 3.8  | 12.63 | x | 10.49 | x | 3.8   |
| AL160567               | FM5044MP        | STEEL      | -----             | 45              | (56)EX TH | 352.3 | x | 279.1     | x | 2.5  | 13.87 | x | 10.99 | x | 0.098 |
| AL160575               | FM5029          | PAPER      | 2 PASS            | 36              | (38)EX TH | 204.1 | x | 132.2     | x | 3.3  | 8.04  | x | 5.2   | x | 0.128 |
| AL160576               | FM5032MP        | STEEL      | -----             | 48              | INT TH    | 190.0 | x | 117.9     | x | 2.5  | 7.48  | x | 4.64  | x | 0.098 |
| AL160577               | FM5036MP        | STEEL      | -----             | 56              | EXT TH    | 327.9 | x | 255.1     | x | 2.5  | 12.91 | x | 10.04 | x | 0.098 |
| AL160578               | FM5033          | PAPER      | 2 PASS            | 97              | (99)IN TH | 314.1 | x | 245.5     | x | 3.2  | 12.37 | x | 9.67  | x | 0.127 |
| AL160831               | FM8016MP        | STEEL      | -----             | 24              | EXT TH    | 352.2 | x | 278.9     | x | 3.3  | 13.87 | x | 10.98 | x | 0.13  |
| AL162808               | FM7631          | PAPER      | 3 PASS            | 14              | INT TH    | 305.8 | x | 36.2      | x | 4.9  | 12.04 | x | 1.43  | x | 0.193 |
| AL171954               | FM2973          | PAPER      | 3 PASS            | 14              | INT TH    | 313.0 | x | 43.4      | x | 4.8  | 12.32 | x | 1.71  | x | 0.189 |
| AL171955               | FM4115          | PAPER      | 3 PASS            | 14              | INT TH    | 313.0 | x | 43.4      | x | 6.0  | 12.32 | x | 1.71  | x | 0.236 |
| AR27727                | FM7075          | PAPER      | WAFFLE            | 6               | EXT LG    | 115.0 | x | 82.6      | x | 2.0  | 4.53  | x | 3.25  | x | 0.079 |
| AR39128                | FM1361          | BRONZE     | SUNBURST          | 45              | INT TH    | 133.1 | x | 92.7      | x | 1.6  | 5.24  | x | 3.65  | x | 0.063 |
| AR44997                | FM7078MP        | STEEL      | -----             | 4               | INT LG    | 104.7 | x | 71.6      | x | 1.2  | 4.11  | x | 2.81  | x | 0.047 |
| AR60082                | FM8233          | PAPER      | WAFFLE            | 48              | INT TH    | 305.5 | x | 149.5     | x | 3.6  | 12.03 | x | 5.89  | x | 0.142 |
| AR67710                | FM8235          | PAPER      | WAFFLE            | 48              | INT TH    | 305.5 | x | 149.5     | x | 3.6  | 12.03 | x | 5.89  | x | 0.142 |
| AR68345                | FM5435          | PAPER      | WAFFLE            | 104             | INT TH    | 322.8 | x | 262.8     | x | 3.3  | 12.71 | x | 10.35 | x | 0.13  |
| AR68945                | FM6145          | PAPER      | 2 PASS            | 42              | INT TH    | 196.0 | x | 130.0     | x | 3.3  | 7.72  | x | 5.12  | x | 0.13  |
| AR69610                | FM5431          | BRONZE     | SUNBURST          | 95              | INT TH    | 295.0 | x | 240.0     | x | 3.1  | 11.61 | x | 9.45  | x | 0.122 |
| AR69611                | FM4935          | PAPER      | WAFFLE            | 54              | INT TH    | 177.8 | x | 112.6     | x | 2.9  | 7     | x | 4.43  | x | 0.114 |
| AR71561                | FM4251          | PAPER      | WAFFLE            | 45              | INT TH    | 133.1 | x | 92.7      | x | 1.9  | 5.24  | x | 3.65  | x | 0.73  |
| AR73183                | FM8235          | PAPER      | WAFFLE            | 48              | INT TH    | 305.5 | x | 149.5     | x | 3.6  | 12.03 | x | 5.89  | x | 0.142 |
| AR73712                | FM8235          | PAPER      | WAFFLE            | 48              | INT TH    | 305.5 | x | 149.5     | x | 3.6  | 12.03 | x | 5.89  | x | 0.142 |
| AR77819                | FM8237          | PAPER      | WAFFLE            | 55              | INT TH    | 109.9 | x | 86.1      | x | 1.8  | 4.33  | x | 3.39  | x | 0.071 |
| AR78361                | FM3707          | PAPER      | 2 PASS            | 45              | INT TH    | 133.1 | x | 92.7      | x | 2.5  | 5.24  | x | 3.65  | x | 0.1   |
| AR87422                | FM3931          | BRONZE     | SUNBURST          | 54              | INT TH    | 177.8 | x | 112.6     | x | 2.9  | 7.0   | x | 4.43  | x | 0.115 |
| AR89320                | FM8235          | PAPER      | WAFFLE            | 48              | INT TH    | 305.5 | x | 149.5     | x | 3.6  | 12.03 | x | 5.89  | x | 0.142 |
| AR94515                | FM5435          | PAPER      | WAFFLE            | 104             | INT TH    | 322.8 | x | 262.8     | x | 3.3  | 12.71 | x | 10.35 | x | 0.13  |
| AR94516                | FM4935          | PAPER      | WAFFLE            | 54              | INT TH    | 177.8 | x | 112.6     | x | 2.9  | 7.0   | x | 4.43  | x | 0.114 |
| AR94517                | FM6145          | PAPER      | 2 PASS            | 42              | INT TH    | 196.0 | x | 130.0     | x | 3.3  | 7.72  | x | 5.12  | x | 0.13  |
| AR94519                | FM8231          | PAPER      | WAFFLE            | 48              | INT TH    | 279.5 | x | 149.6     | x | 3.6  | 11.0  | x | 5.89  | x | 0.142 |
| AR95827                | FM8235          | PAPER      | WAFFLE            | 48              | INT TH    | 305.5 | x | 149.5     | x | 3.6  | 12.03 | x | 5.89  | x | 0.142 |
| AR108105               | FM1649          | PAPER      | 2 PASS            | 45              | INT TH    | 133.1 | x | 92.7      | x | 1.6  | 5.24  | x | 3.65  | x | 0.063 |
| AT22034                | FM2407          | PAPER      | 3 PASS            | 12              | INT TH    | 306.0 | x | 45.5      | x | 10.1 | 12.03 | x | 1.79  | x | 0.402 |
| AT26632                | FM1649          | PAPER      | 2 PASS            | 45              | INT TH    | 133.1 | x | 92.7      | x | 1.6  | 5.24  | x | 3.65  | x | 0.063 |
| AT63106                | FM2327          | GRAPHITE   | SUNBURST          | 12              | INT TH    | 304.8 | x | 45.7      | x | 9.7  | 12    | x | 1.8   | x | 0.38  |
| AT100837               | FM1933          | BRONZE     | RADIAL            | 59              | INT TH    | 190.8 | x | 147.3     | x | 3.0  | 7.51  | x | 5.8   | x | 0.118 |
| AT101001               | FM1649          | PAPER      | 2 PASS            | 45              | INT TH    | 133.1 | x | 92.7      | x | 1.6  | 5.24  | x | 3.65  | x | 0.063 |
| AT179473               | FM6337          | PAPER      | WAFFLE/WAVED      | 40              | INT TH    | 119.7 | x | 79.0      | x | 1.6  | 4.71  | x | 3.11  | x | 0.063 |
| AT179503               | FM6117          | PAPER      | 3 PASS            | 15              | INT TH    | 232.0 | x | 43.0      | x | 5.8  | 9.13  | x | 1.69  | x | 0.228 |
| AT253102               | FM4451          | MOLYBDENUM | SPR/WAG           | 46              | (50)IN TH | 117.5 | x | 62.6      | x | 2.6  | 4.63  | x | 2.46  | x | 0.102 |
| AT253103               | FM4666-2.2      | STEEL      | HARDENED          | 6               | EXT SL    | 130.0 | x | 66.8      | x | 2.2  | 5.12  | x | 2.63  | x | 0.087 |
| AT253104               | FM4666MP        | STEEL      | HARDENED          | 6               | EXT SL    | 130.0 | x | 66.8      | x | 2.3  | 5.12  | x | 2.63  | x | 0.091 |
| AT253105               | FM4666-2.4      | STEEL      | HARDENED          | 6               | EXT SL    | 130.0 | x | 66.8      | x | 2.4  | 5.12  | x | 2.63  | x | 0.094 |
| AT253106               | FM4666-2.5      | STEEL      | HARDENED          | 6               | EXT SL    | 130.0 | x | 66.8      | x | 2.5  | 5.12  | x | 2.63  | x | 0.098 |
| AT255595               | FM5247          | MOLYBDENUM | SPR/WAG           | 40              | INT TH    | 172.0 | x | 84.1      | x | 3.0  | 6.77  | x | 3.31  | x | 0.118 |

| REPLACES<br>OEM PT.NO. | FMC<br>PART NO. | MATERIAL   | GROOVE<br>DETAILS | TEETH/<br>TANGS | SIZE MM |       |   | SIZE INCH |   |      |       |   |       |   |       |
|------------------------|-----------------|------------|-------------------|-----------------|---------|-------|---|-----------|---|------|-------|---|-------|---|-------|
| AT255605               | FM5250-2.9      | STEEL      | HARDENED          | 4               | EXT LG  | 189.8 | x | 92.1      | x | 2.9  | 7.47  | x | 3.63  | x | 0.114 |
| AT255608               | FM5250-3.3      | STEEL      | HARDENED          | 4               | EXT LG  | 189.8 | x | 92.1      | x | 3.3  | 7.47  | x | 3.63  | x | 0.13  |
| AT258946               | FM3801          | PAPER      | RADIAL            | 30              | INT LG  | 329.0 | x | 285.0     | x | 3.0  | 12.96 | x | 11.24 | x | 0.117 |
| AT258949               | FM2279          | BRONZE     | SUNBURST          | 35              | EXT TH  | 177.5 | x | 109.0     | x | 2.0  | 6.99  | x | 4.29  | x | 0.079 |
| AT258951               | FM4125          | BRONZE     | SUN-PLAIN         | 35              | EXT TH  | 177.5 | x | 109.0     | x | 1.6  | 6.99  | x | 4.29  | x | 0.063 |
| AT300740               | FM6393          | PAPER      | WAFFLE            | 95              | INT TH  | 295.0 | x | 240.0     | x | 3.1  | 11.61 | x | 9.45  | x | 0.12  |
| AT315888               | FM2327          | GRAPHITE   | SUNBURST          | 12              | INT TH  | 304.8 | x | 45.7      | x | 9.7  | 12.0  | x | 1.8   | x | 0.38  |
| AT321450               | FM4089          | PAPER      | 3 PASS            | 48              | INT TH  | 232.7 | x | 142.0     | x | 4.0  | 9.16  | x | 5.59  | x | 0.157 |
| AT321696               | FM6393          | PAPER      | WAFFLE            | 95              | INT TH  | 295.0 | x | 240.0     | x | 3.1  | 11.61 | x | 9.45  | x | 0.12  |
| AT321802               | FM4686MP        | STEEL      | -----             | 81              | EXT TH  | 243.6 | x | 152.1     | x | 2.5  | 9.59  | x | 5.99  | x | 0.098 |
| AT321804               | FM6896MP        | STEEL      | -----             | 81              | EXT TH  | 243.6 | x | 152.1     | x | 2.0  | 9.59  | x | 5.99  | x | 0.079 |
| AT322016               | FM4650MP        | STEEL      | -----             | 24              | EXT TH  | 108.2 | x | 76.2      | x | 1.2  | 4.26  | x | 3.0   | x | 0.045 |
| AT322021               | FM4647          | BRONZE     | SPR/RAD           | 34              | INT TH  | 100.0 | x | 68.2      | x | 1.6  | 3.94  | x | 2.69  | x | 0.061 |
| AT322029               | FM7038MP        | STEEL      | HARD/BLACK        | 64              | EXT TH  | 196.4 | x | 140.0     | x | 2.9  | 7.73  | x | 5.51  | x | 0.114 |
| AT322030               | FM7038MP        | STEEL      | HARD/BLACK        | 64              | EXT TH  | 196.4 | x | 140.0     | x | 2.9  | 7.73  | x | 5.51  | x | 0.114 |
| AT322033               | FM7038-3.5      | STEEL      | HARD/BLACK        | 64              | EXT TH  | 196.4 | x | 140.0     | x | 3.5  | 7.73  | x | 5.51  | x | 0.138 |
| AT322036               | FM4933          | BRONZE     | WAF/WAG           | 45              | INT TH  | 187.0 | x | 132.6     | x | 3.0  | 7.36  | x | 5.22  | x | 0.118 |
| AT325657               | FM2815          | PAPER      | 4 PASS            | 42              | INT TH  | 340.0 | x | 206.0     | x | 5.5  | 13.39 | x | 8.11  | x | 0.217 |
| AT339059               | FM7521          | PAPER      | 3 PASS            | 48              | INT TH  | 233.0 | x | 141.5     | x | 5.5  | 9.17  | x | 5.57  | x | 0.217 |
| AT339543               | FM7523          | PAPER      | 3 PASS            | 20              | INT TH  | 233.0 | x | 59.5      | x | 5.5  | 9.17  | x | 2.34  | x | 0.217 |
| AT339922               | FM7677          | CARBON PA  | WAFFLE            | 34              | INT TH  | 109.7 | x | 68.4      | x | 1.6  | 4.32  | x | 2.69  | x | 0.063 |
| AT365001               | FM9477KIT       | KIT        |                   |                 |         |       |   |           |   |      |       |   |       |   |       |
| AZ40478                | FM2407          | PAPER      | 3 PASS            | 12              | INT TH  | 306.0 | x | 45.5      | x | 10.1 | 12.03 | x | 1.79  | x | 0.402 |
| DJ13290                | FM5073          | PAPER      | 3 PASS            | 15              | INT TH  | 305.8 | x | 55.4      | x | 5.9  | 12.04 | x | 2.18  | x | 0.232 |
| DJ13291                | FM5071          | OBSOLETE   | 3 PASS            | 12              | INT TH  | 305.8 | x | 42.9      | x | 5.9  | 12.04 | x | 1.69  | x | 0.232 |
| ER117167               | FM3356MP        | STEEL      | -----             | 1               | EXT LG  | 172.0 | x | 94.0      | x | 2.7  | 6.77  | x | 3.7   | x | 0.104 |
| ER143847               | FM5201          | PAPER      | WAFFLE            | 22              | INT TH  | 165.0 | x | 41.0      | x | 4.7  | 6.5   | x | 1.61  | x | 0.185 |
| F045019                | FM4720MP        | STEEL      | -----             | 2               | EXT LG  | 196.0 | x | 110.0     | x | 2.5  | 7.72  | x | 4.33  | x | 0.098 |
| F047367                | FM5210MP        | STEEL      | -----             | 2               | EXT LG  | 253.0 | x | 150.0     | x | 2.6  | 9.96  | x | 5.91  | x | 0.102 |
| F056912                | FM4717          | GRAPHITE   | SUNBURST          | 24              | INT TH  | 169.0 | x | 45.1      | x | 4.8  | 6.65  | x | 1.78  | x | 0.189 |
| F057733                | FM8633          | GRAPHITE   | SUNBURST          | 20              | INT TH  | 169.0 | x | 36.0      | x | 4.8  | 6.65  | x | 1.42  | x | 0.189 |
| F062284                | FM8629          | GRAPHITE   | WAFFLE            | 26              | INT TH  | 223.6 | x | 51.3      | x | 4.8  | 8.8   | x | 2.02  | x | 0.189 |
| F072092                | FM4720MP        | STEEL      | -----             | 2               | EXT LG  | 196.0 | x | 110.0     | x | 2.5  | 7.72  | x | 4.33  | x | 0.098 |
| F072815                | FM9163          | GRAPHITE   | SUNBURST          | 22              | INT TH  | 169.0 | x | 41.1      | x | 4.9  | 6.65  | x | 1.62  | x | 0.193 |
| F432901                | FM9482MP        | STEEL      | HARDENED          | 22              | INT TH  | 122.8 | x | 64.5      | x | 1.5  | 4.83  | x | 2.54  | x | 0.057 |
| F434849                | FM9479          | BRONZE     | WAFFLE            | 32              | EXT TH  | 133.1 | x | 92.0      | x | 2.1  | 5.24  | x | 3.62  | x | 0.083 |
| F437205                | FM5250-3.0      | STEEL      | HARDENED          | 4               | EXT LG  | 189.8 | x | 92.1      | x | 3.0  | 7.47  | x | 3.63  | x | 0.118 |
| F437207                | FM5250-3.1      | STEEL      | HARDENED          | 4               | EXT LG  | 189.8 | x | 92.1      | x | 3.1  | 7.47  | x | 3.63  | x | 0.122 |
| F437208                | FM5250-2.7      | STEEL      | HARDENED          | 4               | EXT LG  | 189.8 | x | 92.1      | x | 2.7  | 7.47  | x | 3.63  | x | 0.106 |
| F437216                | FM4183          | PAPER      | WAF/WAG           | 64              | INT TH  | 345.0 | x | 252.1     | x | 4.7  | 13.58 | x | 9.93  | x | 0.185 |
| F437223                | FM5572MP        | STEEL      | -----             | 20              | EXT LG  | 372.5 | x | 262.5     | x | 2.0  | 14.67 | x | 10.33 | x | 0.079 |
| L33125                 | FM6228MP        | STEEL      | -----             | 3               | EXT LG  | 120.4 | x | 86.0      | x | 2.9  | 4.74  | x | 3.39  | x | 0.114 |
| L33163                 | FM6234MP        | STEEL      | SINEWAVED         | 6               | EXT LG  | 196.0 | x | 168.0     | x | 2.3  | 7.72  | x | 6.61  | x | 0.091 |
| L33497                 | FM2990MP        | STEEL      | -----             | 4               | EXT LG  | 321.9 | x | 212.1     | x | 6.0  | 12.67 | x | 8.35  | x | 0.237 |
| L34062                 | FM8720MP        | STEEL      | HARD/SPR          | 6               | EXT LG  | 155.6 | x | 99.1      | x | 1.4  | 6.13  | x | 3.9   | x | 0.053 |
| L34064                 | FM8718MP        | STEEL      | HARDENED          | 51              | INT TH  | 140.8 | x | 79.5      | x | 1.5  | 5.54  | x | 3.13  | x | 0.06  |
| L40003                 | FM8999          | MOLYBDENUM | -----             | 36              | INT TH  | 71.7  | x | 44.8      | x | 1.5  | 2.82  | x | 1.76  | x | 0.059 |
| L40624                 | FM8718MP        | STEEL      | HARDENED          | 51              | INT TH  | 140.8 | x | 79.5      | x | 1.5  | 5.54  | x | 3.13  | x | 0.06  |

| REPLACES<br>OEM PT.NO. | FMC<br>PART NO. | MATERIAL | GROOVE<br>DETAILS | TEETH/<br>TANGS | SIZE MM |       |   | SIZE INCH |   |     |       |   |       |   |       |
|------------------------|-----------------|----------|-------------------|-----------------|---------|-------|---|-----------|---|-----|-------|---|-------|---|-------|
| L41864                 | FM8720MP        | STEEL    | HARD/SPR          | 6               | EXT LG  | 155.6 | x | 99.1      | x | 1.4 | 6.13  | x | 3.9   | x | 0.053 |
| L55004                 | FM3130MP        | STEEL    | -----             | 4               | EXT LG  | 321.9 | x | 220.0     | x | 14  | 12.67 | x | 8.66  | x | 0.551 |
| L64752                 | FM2156MP        | STEEL    | -----             | 10              | EXT TH  | 142.7 | x | 99.1      | x | 2.3 | 5.62  | x | 3.9   | x | 0.09  |
| L77358                 | FM7634MP        | STEEL    | -----             | 3               | EXT LG  | 346.5 | x | 242.0     | x | 6.0 | 13.64 | x | 9.53  | x | 0.236 |
| L150355                | FM3575          | PAPER    | 3 PASS            | 35              | INT TH  | 179.0 | x | 103.0     | x | 3.5 | 7.05  | x | 4.05  | x | 0.138 |
| L152006                | FM4089          | PAPER    | 3 PASS            | 48              | INT TH  | 232.7 | x | 142.0     | x | 4.0 | 9.16  | x | 5.59  | x | 0.157 |
| R17344                 | FM6370MP        | STEEL    | -----             | 4               | EXT LG  | 334.0 | x | 238.0     | x | 4.0 | 13.15 | x | 9.37  | x | 0.157 |
| R31404R                | FM3931          | BRONZE   | SUNBURST          | 54              | INT TH  | 177.8 | x | 112.6     | x | 2.9 | 7.0   | x | 4.43  | x | 0.115 |
| R33873                 | FM5424MP        | STEEL    | -----             | 6               | EXT LG  | 195.0 | x | 120.7     | x | 3.2 | 7.68  | x | 4.75  | x | 0.124 |
| R34857                 | FM9474MP        | STEEL    | -----             | 12              | EXT LG  | 252.0 | x | 157.0     | x | 3.0 | 9.92  | x | 6.18  | x | 0.118 |
| R34858                 | FM9470MP        | STEEL    | -----             | 9               | EXT LG  | 255.4 | x | 157.2     | x | 3.0 | 10.06 | x | 6.19  | x | 0.118 |
| R39259                 | FM2326MP        | STEEL    | -----             | 6               | EXT LG  | 142.0 | x | 99.1      | x | 1.6 | 5.59  | x | 3.9   | x | 0.063 |
| R39325                 | FM4978MP        | STEEL    | -----             | 6               | EXT LG  | 197.2 | x | 120.7     | x | 2.3 | 7.76  | x | 4.75  | x | 0.091 |
| R46391                 | FM5424MP        | STEEL    | -----             | 6               | EXT LG  | 195.0 | x | 120.7     | x | 3.2 | 7.68  | x | 4.75  | x | 0.124 |
| R57345                 | FM4978MP        | STEEL    | -----             | 6               | EXT LG  | 197.2 | x | 120.7     | x | 2.3 | 7.76  | x | 4.75  | x | 0.091 |
| R64197                 | FM3132MP        | STEEL    | -----             | 6               | EXT LG  | 152.0 | x | 99.0      | x | 1.5 | 5.98  | x | 3.9   | x | 0.06  |
| R80813                 | FM5424MP        | STEEL    | -----             | 6               | EXT LG  | 195.0 | x | 120.7     | x | 3.2 | 7.68  | x | 4.75  | x | 0.124 |
| R95110                 | FM8854MP        | STEEL    | -----             | 6               | EXT LG  | 216.0 | x | 138.0     | x | 3.0 | 8.5   | x | 5.43  | x | 0.118 |
| R95313                 | FM8710MP        | STEEL    | -----             | 4               | EXT LG  | 333.1 | x | 238.4     | x | 4.0 | 13.11 | x | 9.39  | x | 0.157 |
| R95378                 | FM6386MP        | STEEL    | -----             | 4               | EXT LG  | 330.0 | x | 247.0     | x | 6.0 | 12.99 | x | 9.72  | x | 0.236 |
| R95422                 | FM6368MP        | STEEL    | -----             | 4               | EXT LG  | 347.2 | x | 247.1     | x | 6.0 | 13.67 | x | 9.73  | x | 0.236 |
| R96805                 | FM6380MP        | STEEL    | -----             | 6               | EXT LG  | 250.8 | x | 139.9     | x | 7.0 | 9.87  | x | 5.51  | x | 0.276 |
| R96806                 | FM6382MP        | STEEL    | -----             | 6               | EXT LG  | 277.3 | x | 134.9     | x | 7.0 | 8.95  | x | 5.31  | x | 0.276 |
| R101158                | FM6872MP        | STEEL    | -----             | 4               | EXT LG  | 333.8 | x | 238.2     | x | 3.0 | 13.14 | x | 9.38  | x | 0.118 |
| R101160                | FM6372MP        | STEEL    | -----             | 4               | EXT LG  | 347.5 | x | 238.0     | x | 5.0 | 13.68 | x | 9.37  | x | 0.197 |
| R101165                | FM6378MP        | STEEL    | -----             | 6               | EXT LG  | 218.0 | x | 120.0     | x | 3.0 | 8.58  | x | 4.72  | x | 0.118 |
| R114215                | FM6374MP        | STEEL    | -----             | 4               | EXT LG  | 334.0 | x | 238.0     | x | 4.0 | 13.15 | x | 9.37  | x | 0.157 |
| R116894                | FM6376MP        | STEEL    | -----             | 6               | EXT LG  | 216.0 | x | 118.0     | x | 3.0 | 8.5   | x | 4.65  | x | 0.118 |
| R150895                | FM8688MP        | STEEL    | -----             | 6               | EXT LG  | 429.8 | x | 277.5     | x | 3.0 | 16.92 | x | 10.93 | x | 0.118 |
| R169442                | FM6384MP        | STEEL    | -----             | 4               | EXT LG  | 334.0 | x | 238.0     | x | 3.2 | 13.15 | x | 9.37  | x | 0.126 |
| R173444                | FM8710MP        | STEEL    | -----             | 4               | EXT LG  | 333.1 | x | 238.4     | x | 4.0 | 13.11 | x | 9.39  | x | 0.157 |
| R209938                | FM6372MP        | STEEL    | -----             | 4               | EXT LG  | 347.5 | x | 238.0     | x | 5.0 | 13.68 | x | 9.37  | x | 0.197 |
| R216291                | FM6384MP        | STEEL    | -----             | 4               | EXT LG  | 334.0 | x | 238.0     | x | 3.2 | 13.15 | x | 9.37  | x | 0.126 |
| R216292                | FM6374MP        | STEEL    | -----             | 4               | EXT LG  | 334.0 | x | 238.0     | x | 4.0 | 13.15 | x | 9.37  | x | 0.157 |
| R216293                | FM6370MP        | STEEL    | -----             | 4               | EXT LG  | 334.0 | x | 238.0     | x | 4.0 | 13.15 | x | 9.37  | x | 0.157 |
| R216294                | FM6376MP        | STEEL    | -----             | 6               | EXT LG  | 216.0 | x | 118.0     | x | 3.0 | 8.5   | x | 4.65  | x | 0.118 |
| R220471                | FM6378MP        | STEEL    | -----             | 6               | EXT LG  | 218.0 | x | 120.0     | x | 3.0 | 8.58  | x | 4.72  | x | 0.118 |
| R227405                | FM5431          | BRONZE   | SUNBURST          | 95              | INT TH  | 295.0 | x | 240.0     | x | 3.1 | 11.61 | x | 9.45  | x | 0.122 |
| R271542                | FM6230MP        | STEEL    | -----             | 4               | EXT LG  | 184.0 | x | 134.0     | x | 2.0 | 7.24  | x | 5.28  | x | 0.079 |
| R283067                | FM9452MP        | STEEL    | -----             | 4               | EXT LG  | 146.0 | x | 92.5      | x | 4.0 | 7.75  | x | 3.64  | x | 0.157 |
| RE17162                | FM6393          | PAPER    | WAFFLE            | 95              | INT TH  | 295.0 | x | 240.0     | x | 3.1 | 11.61 | x | 9.45  | x | 0.12  |
| RE17420                | FM8233          | PAPER    | WAFFLE            | 48              | INT TH  | 305.5 | x | 149.5     | x | 3.6 | 12.03 | x | 5.89  | x | 0.142 |
| RE23000                | FM3931          | BRONZE   | SUNBURST          | 54              | INT TH  | 177.8 | x | 112.6     | x | 2.9 | 7.0   | x | 4.43  | x | 0.115 |
| RE23286                | FM6145          | PAPER    | 2 PASS            | 42              | INT TH  | 196.0 | x | 130.0     | x | 3.3 | 7.72  | x | 5.12  | x | 0.13  |
| RE27995                | FM3931          | BRONZE   | SUNBURST          | 54              | INT TH  | 177.8 | x | 112.6     | x | 2.9 | 7.0   | x | 4.43  | x | 0.115 |
| RE29816                | FM4251          | PAPER    | WAFFLE            | 45              | INT TH  | 133.1 | x | 92.7      | x | 1.9 | 5.24  | x | 3.65  | x | 0.73  |
| RE33053                | FM5431          | BRONZE   | SUNBURST          | 95              | INT TH  | 295.0 | x | 240.0     | x | 3.1 | 11.61 | x | 9.45  | x | 0.122 |

| REPLACES<br>OEM PT.NO. | FMC<br>PART NO. | MATERIAL  | GROOVE<br>DETAILS | TEETH/<br>TANGS | SIZE MM   |       |   | SIZE INCH |   |     |       |   |       |   |       |
|------------------------|-----------------|-----------|-------------------|-----------------|-----------|-------|---|-----------|---|-----|-------|---|-------|---|-------|
| RE33706                | FM8833          | PAPER     | WAFFLE            | 6               | INT LG    | 242.0 | x | 198.2     | x | 4.5 | 9.53  | x | 7.8   | x | 0.175 |
| RE34784                | FM6389          | PAPER     | WAFFLE            | 87              | INT TH    | 292.0 | x | 218.5     | x | 3.2 | 11.5  | x | 8.6   | x | 0.126 |
| RE34786                | FM6395          | PAPER     | WAFFLE            | 54              | INT TH    | 285.0 | x | 112.5     | x | 3.3 | 11.22 | x | 4.43  | x | 0.13  |
| RE34868                | FM6231          | PAPER     | 2 PASS            | 51              | INT TH    | 169.0 | x | 124.0     | x | 2.8 | 6.65  | x | 4.88  | x | 0.11  |
| RE35512                | FM6855          | PAPER     | WAFFLE            | 50              | (60)IN TH | 225.0 | x | 125.0     | x | 3.6 | 8.86  | x | 4.92  | x | 0.142 |
| RE36170                | FM8237          | PAPER     | WAFFLE            | 55              | INT TH    | 109.9 | x | 86.1      | x | 1.8 | 4.33  | x | 3.39  | x | 0.071 |
| RE37011                | FM1649          | PAPER     | 2 PASS            | 45              | INT TH    | 133.1 | x | 92.7      | x | 1.6 | 5.24  | x | 3.65  | x | 0.063 |
| RE37119                | FM7075KIT       | KIT       |                   |                 |           |       |   |           |   |     |       |   |       |   |       |
| RE45938                | FM2969          | BRONZE    | WAFFLE            | 22              | INT TH    | 71.7  | x | 44.0      | x | 1.6 | 2.82  | x | 1.73  | x | 0.063 |
| RE47082                | FM4201          | PAPER     | 2 PASS            | 15              | INT TH    | 334.0 | x | 57.6      | x | 7.7 | 13.15 | x | 2.27  | x | 0.303 |
| RE48092                | FM6393          | PAPER     | WAFFLE            | 95              | INT TH    | 295.0 | x | 240.0     | x | 3.1 | 11.61 | x | 9.45  | x | 0.12  |
| RE51687                | FM4703          | OBSOLETE  | WAFFLE            | 12              | INT TH    | 335.0 | x | 60.7      | x | 7.7 | 13.19 | x | 2.39  | x | 0.303 |
| RE53823                | FM9463          | CARBON PA | 2 PASS            | 47              | INT TH    | 228.4 | x | 146.3     | x | 3.2 | 8.99  | x | 5.76  | x | 0.126 |
| RE62896                | FM9465          | CARBON PA | WAFFLE            | 39              | INT TH    | 177.7 | x | 60.6      | x | 4.6 | 7.0   | x | 2.39  | x | 0.179 |
| RE62897                | FM5435          | PAPER     | WAFFLE            | 104             | INT TH    | 322.8 | x | 262.8     | x | 3.3 | 12.71 | x | 10.35 | x | 0.13  |
| RE64006                | FM4201          | PAPER     | 2 PASS            | 15              | INT TH    | 334.0 | x | 57.6      | x | 7.7 | 13.15 | x | 2.27  | x | 0.303 |
| RE65008                | FM8685          | PAPER     | WAFFLE            | 104             | INT TH    | 381.7 | x | 262.7     | x | 3.4 | 15.03 | x | 10.34 | x | 0.132 |
| RE65197                | FM8707          | PAPER     | WAFFLE            | 15              | INT TH    | 387.2 | x | 63.4      | x | 7.7 | 15.24 | x | 2.5   | x | 0.303 |
| RE65291                | FM6145          | PAPER     | 2 PASS            | 42              | INT TH    | 196.0 | x | 130.0     | x | 3.3 | 7.72  | x | 5.12  | x | 0.13  |
| RE70175                | FM4201          | PAPER     | 2 PASS            | 15              | INT TH    | 334.0 | x | 57.6      | x | 7.7 | 13.15 | x | 2.27  | x | 0.303 |
| RE151059               | FM6387          | PAPER     | WAFFLE            | 87              | INT TH    | 292.0 | x | 218.5     | x | 5.2 | 11.5  | x | 8.6   | x | 0.205 |
| RE160072               | FM4201          | PAPER     | 2 PASS            | 15              | INT TH    | 334.0 | x | 57.6      | x | 7.7 | 13.15 | x | 2.27  | x | 0.303 |
| RE186965               | FM8707          | PAPER     | WAFFLE            | 15              | INT TH    | 387.2 | x | 63.4      | x | 7.7 | 15.24 | x | 2.5   | x | 0.303 |
| RE186966               | FM4201          | PAPER     | 2 PASS            | 15              | INT TH    | 334.0 | x | 57.6      | x | 7.7 | 13.15 | x | 2.27  | x | 0.303 |
| RE227812               | FM6187          | BRONZE    | SUNBURST          | 45              | INT TH    | 133.1 | x | 92.7      | x | 1.6 | 5.24  | x | 3.65  | x | 0.063 |
| RE234259               | FM5435          | PAPER     | WAFFLE            | 104             | INT TH    | 322.8 | x | 262.8     | x | 3.3 | 12.71 | x | 10.35 | x | 0.13  |
| RE234261               | FM6145          | PAPER     | 2 PASS            | 42              | INT TH    | 196.0 | x | 130.0     | x | 3.3 | 7.72  | x | 5.12  | x | 0.13  |
| RE234264               | FM8235          | PAPER     | WAFFLE            | 48              | INT TH    | 305.5 | x | 149.5     | x | 3.6 | 12.03 | x | 5.89  | x | 0.142 |
| RE234305               | FM6393          | PAPER     | WAFFLE            | 95              | INT TH    | 295.0 | x | 240.0     | x | 3.1 | 11.61 | x | 9.45  | x | 0.12  |
| RE234305               | FM5431          | BRONZE    | SUNBURST          | 95              | INT TH    | 295.0 | x | 240.0     | x | 3.1 | 11.61 | x | 9.45  | x | 0.122 |
| RE234306               | FM8233          | PAPER     | WAFFLE            | 48              | INT TH    | 305.5 | x | 149.5     | x | 3.6 | 12.03 | x | 5.89  | x | 0.142 |
| RE234307               | FM3931          | BRONZE    | SUNBURST          | 54              | INT TH    | 177.8 | x | 112.6     | x | 2.9 | 7.0   | x | 4.43  | x | 0.115 |
| RE239058               | FM6391          | PAPER     | WAFFLE            | 54              | INT TH    | 177.8 | x | 112.6     | x | 2.9 | 7.0   | x | 4.43  | x | 0.114 |
| RE239059               | FM8231          | PAPER     | WAFFLE            | 48              | INT TH    | 279.5 | x | 149.6     | x | 3.6 | 11    | x | 5.89  | x | 0.142 |
| RE273492               | FM6395          | PAPER     | WAFFLE            | 54              | INT TH    | 285.0 | x | 112.5     | x | 3.3 | 11.22 | x | 4.43  | x | 0.13  |
| RE283066               | FM9449          | PAPER     | WAFFLE            | 57              | (58)IN TH | 129.0 | x | 85.9      | x | 2.9 | 5.08  | x | 3.38  | x | 0.112 |
| RE292441               | FM8619          | CARBON PA | WAFFLE            | 15              | INT TH    | 388.0 | x | 63.7      | x | 7.5 | 15.28 | x | 2.51  | x | 0.295 |
| RE292445               | FM4201          | PAPER     | 2 PASS            | 15              | INT TH    | 334.0 | x | 57.6      | x | 7.7 | 13.15 | x | 2.27  | x | 0.303 |
| RE293333               | FM8231          | PAPER     | WAFFLE            | 48              | INT TH    | 279.5 | x | 149.6     | x | 3.6 | 11.0  | x | 5.89  | x | 0.142 |
| RE321692               | FM6855          | PAPER     | WAFFLE            | 50              | (60)IN TH | 225.0 | x | 125.0     | x | 3.6 | 8.86  | x | 4.92  | x | 0.142 |
| RE321696               | FM6393          | PAPER     | WAFFLE            | 95              | INT TH    | 295.0 | x | 240.0     | x | 3.1 | 11.61 | x | 9.45  | x | 0.12  |
| RE324245               | FM8619          | CARBON PA | WAFFLE            | 15              | INT TH    | 388.0 | x | 63.7      | x | 7.5 | 15.28 | x | 2.51  | x | 0.295 |
| RE326609               | FM6391          | PAPER     | WAFFLE            | 54              | INT TH    | 177.8 | x | 112.6     | x | 2.9 | 7.0   | x | 4.43  | x | 0.114 |
| T15801                 | FM1801          | BRONZE    | WAFFLE            | 76              | EXT TH    | 164.1 | x | 103.1     | x | 2.8 | 6.46  | x | 4.06  | x | 0.11  |
| T28664                 | FM2156MP        | STEEL     | -----             | 10              | EXT TH    | 142.7 | x | 99.1      | x | 2.3 | 5.62  | x | 3.9   | x | 0.09  |
| T31732                 | FM3472MP        | STEEL     | -----             | 6               | EXT LG    | 301.6 | x | 206.5     | x | 3.2 | 11.87 | x | 8.13  | x | 0.126 |
| T41472                 | FM3469          | PAPER     | RAD/WAG           | 38              | INT TH    | 276.6 | x | 188.7     | x | 4.8 | 10.89 | x | 7.43  | x | 0.189 |
| T44804                 | FM1220MP        | STEEL     | -----             | 40              | INT TH    | 152.4 | x | 82.3      | x | 1.6 | 6.0   | x | 3.24  | x | 0.063 |

| REPLACES<br>OEM PT.NO. | FMC<br>PART NO. | MATERIAL    | GROOVE<br>DETAILS | TEETH/<br>TANGS | SIZE MM |       |   | SIZE INCH |   |     |       |   |      |   |       |
|------------------------|-----------------|-------------|-------------------|-----------------|---------|-------|---|-----------|---|-----|-------|---|------|---|-------|
| T44805                 | FM1801          | BRONZE      | WAFFLE            | 76              | EXT TH  | 164.1 | x | 103.1     | x | 2.8 | 6.46  | x | 4.06 | x | 0.11  |
| T67544                 | FM1965          | BRONZE      | SPR/WAG           | 60              | INT TH  | 253.5 | x | 187.7     | x | 3.9 | 9.98  | x | 7.39 | x | 0.153 |
| T82355                 | FM3469          | PAPER       | RAD/WAG           | 38              | INT TH  | 276.6 | x | 188.7     | x | 4.8 | 10.89 | x | 7.43 | x | 0.189 |
| T100680                | FM1324MP        | STEEL       | -----             | 54              | EXT TH  | 139.2 | x | 98.6      | x | 1.8 | 5.48  | x | 3.88 | x | 0.07  |
| T100681                | FM1938MP        | STEEL       | -----             | 3               | EXT LG  | 214.9 | x | 155.7     | x | 1.8 | 8.46  | x | 6.13 | x | 0.07  |
| T101003                | FM5452MP        | STEEL       | END PLATE         | 54              | EXT TH  | 139.2 | x | 98.2      | x | 8.7 | 5.48  | x | 3.87 | x | 0.343 |
| T101004                | FM5442MP        | STEEL       | END PLATE         | 54              | EXT TH  | 139.2 | x | 98.2      | x | 8.3 | 5.48  | x | 3.87 | x | 0.327 |
| T101005                | FM4222SP        | STEEL       | SPRING            | 8               | INT TH  | 134.7 | x | 73.6      | x | 1.8 | 5.3   | x | 2.9  | x | 0.071 |
| T116387                | FM2277          | BRONZE      | SUNBURST          | 27              | EXT TH  | 137.4 | x | 90.9      | x | 2.0 | 5.41  | x | 3.58 | x | 0.079 |
| T116584                | FM3592MP        | STEEL       | -----             | 29              | INT TH  | 131.1 | x | 85.1      | x | 1.5 | 5.16  | x | 3.35 | x | 0.059 |
| T116585                | FM3596MP        | STEEL       | -----             | 29              | INT TH  | 131.1 | x | 85.1      | x | 2.5 | 5.16  | x | 3.35 | x | 0.098 |
| T116586                | FM3594MP        | STEEL       | -----             | 29              | INT TH  | 131.1 | x | 85.1      | x | 2.0 | 5.16  | x | 3.35 | x | 0.079 |
| T116981                | FM3602MP        | STEEL       | -----             | 35              | INT TH  | 170.9 | x | 102.9     | x | 2.0 | 6.73  | x | 4.05 | x | 0.079 |
| T122806                | FM2279          | BRONZE      | SUNBURST          | 35              | EXT TH  | 177.5 | x | 109.0     | x | 2.0 | 6.99  | x | 4.29 | x | 0.079 |
| T140926                | FM1324MP        | STEEL       | -----             | 54              | EXT TH  | 139.2 | x | 98.6      | x | 1.8 | 5.48  | x | 3.88 | x | 0.07  |
| T144659                | FM4123          | BRONZE      | SUN-PLAIN         | 27              | EXT TH  | 137.4 | x | 90.9      | x | 1.6 | 5.41  | x | 3.58 | x | 0.063 |
| T148934                | FM9472MP        | STEEL       | -----             | 6               | EXT LG  | 194.7 | x | 117.2     | x | 4.8 | 7.67  | x | 4.61 | x | 0.189 |
| T158801                | FM5970MP        | STEEL       | -----             | 30              | EXT TH  | 130.9 | x | 86.8      | x | 1.8 | 5.15  | x | 3.42 | x | 0.071 |
| T159409                | FM6120-3.0      | STEEL       | -----             | 81              | EXT TH  | 243.5 | x | 153.0     | x | 3.0 | 9.59  | x | 6.02 | x | 0.118 |
| T159474                | FM9042MP        | STEEL       | HARDENED          | 8               | EXT LG  | 160.0 | x | 109.5     | x | 4.0 | 6.3   | x | 4.31 | x | 0.157 |
| T159475                | FM8937          | BRONZE      | SPR/RAD           | 34              | INT TH  | 141.5 | x | 99.0      | x | 4.0 | 5.57  | x | 3.9  | x | 0.157 |
| T161233                | FM6120-4.0      | STEEL       | -----             | 81              | EXT TH  | 243.5 | x | 153.0     | x | 4.0 | 9.59  | x | 6.02 | x | 0.157 |
| T164626                | FM5967          | PAPER       | WAFFLE            | 40              | INT TH  | 119.7 | x | 79.0      | x | 1.6 | 4.71  | x | 3.11 | x | 0.063 |
| T169604                | FM6783          | CARBON PA   | RADIAL/PLAIN      | 64              | EXT TH  | 196.0 | x | 142.0     | x | 2.0 | 7.72  | x | 5.59 | x | 0.079 |
| T169608                | FM6781          | CARBON PA   | RADIAL            | 64              | EXT TH  | 196.0 | x | 142.0     | x | 2.6 | 7.72  | x | 5.59 | x | 0.1   |
| T173636                | FM4789          | PAPER/PLAIN | RADIAL            | 44              | EXT TH  | 158.8 | x | 111.5     | x | 1.9 | 6.25  | x | 4.39 | x | 0.075 |
| T173637                | FM4787          | CARBON PA   | RADIAL            | 44              | EXT TH  | 158.8 | x | 111.5     | x | 2.5 | 6.25  | x | 4.39 | x | 0.098 |
| T173638                | FM4790MP        | STEEL       | -----             | 42              | INT TH  | 150.9 | x | 102.5     | x | 2.5 | 5.94  | x | 4.04 | x | 0.098 |
| T173640                | FM6111          | CARBON PA   | RADIAL            | 27              | EXT TH  | 137.0 | x | 93.7      | x | 2.5 | 5.39  | x | 3.69 | x | 0.098 |
| T173641                | FM6113          | PAPER/PLAIN | RADIAL            | 27              | EXT TH  | 137.0 | x | 93.7      | x | 1.9 | 5.39  | x | 3.69 | x | 0.073 |
| T173642                | FM6116MP        | STEEL       | -----             | 35              | INT TH  | 129.6 | x | 84.8      | x | 2.5 | 5.1   | x | 3.34 | x | 0.098 |
| T173840                | FM4785          | PAPER/PLAIN | RADIAL            | 34              | EXT TH  | 177.4 | x | 111.5     | x | 1.9 | 6.98  | x | 4.39 | x | 0.075 |
| T173841                | FM4783          | CARBON PA   | RADIAL            | 34              | EXT TH  | 177.4 | x | 111.5     | x | 2.5 | 6.98  | x | 4.39 | x | 0.098 |
| T173842                | FM4786MP        | STEEL       | -----             | 42              | INT TH  | 167.8 | x | 102.5     | x | 2.5 | 6.61  | x | 4.04 | x | 0.098 |
| T182783                | FM4298MP        | STEEL       | -----             | 45              | INT TH  | 170.0 | x | 132.7     | x | 2.5 | 6.69  | x | 5.22 | x | 0.098 |
| T182784                | FM8595          | CARBON PA   | RADIAL            | 35              | EXT TH  | 176.5 | x | 142.0     | x | 2.5 | 6.95  | x | 5.51 | x | 0.096 |
| T182785                | FM8597          | CARBON PA   | RADIAL/PLAIN      | 35              | EXT TH  | 176.5 | x | 142.0     | x | 1.9 | 6.95  | x | 5.51 | x | 0.073 |
| T196011                | FM4302MP        | STEEL       | -----             | 45              | INT TH  | 170.0 | x | 132.7     | x | 3.5 | 6.69  | x | 5.22 | x | 0.138 |
| T196012                | FM4300MP        | STEEL       | -----             | 45              | INT TH  | 170.0 | x | 132.7     | x | 3.0 | 6.69  | x | 5.22 | x | 0.118 |
| T197814                | FM2815          | PAPER       | 4 PASS            | 42              | INT TH  | 340.0 | x | 206.0     | x | 5.5 | 13.39 | x | 8.11 | x | 0.217 |
| T217757                | FM3610MP        | STEEL       | -----             | 91              | EXT TH  | 355.0 | x | 217.0     | x | 4.5 | 13.98 | x | 8.54 | x | 0.177 |
| T217758                | FM3612MP        | STEEL       | -----             | 91              | EXT TH  | 355.0 | x | 217.0     | x | 5.0 | 13.98 | x | 8.54 | x | 0.197 |
| T217760                | FM3614MP        | STEEL       | -----             | 91              | EXT TH  | 355.0 | x | 217.0     | x | 5.5 | 13.98 | x | 8.54 | x | 0.217 |
| T228727                | FM7526MP        | STEEL       | -----             | 4               | EXT LG  | 251.0 | x | 153.6     | x | 4.0 | 9.88  | x | 6.05 | x | 0.157 |
| T229406                | FM7680MP        | STEEL       | DISHED            | 30              | EXT TH  | 119.8 | x | 75.3      | x | 1.8 | 4.72  | x | 2.96 | x | 0.071 |
| YZ90355                | FM1202MP        | STEEL       | -----             | 1               | EXT LG  | 209.3 | x | 114.3     | x | 2.7 | 8.24  | x | 4.5  | x | 0.106 |
| YZ120964               | FM9467          | CARBON PA   | WAFFLE            | 47              | INT TH  | 291.0 | x | 146.0     | x | 3.4 | 11.46 | x | 5.74 | x | 0.134 |



| REPLACES<br>OEM PT.NO. | FMC<br>PART NO. | MATERIAL             | GROOVE<br>DETAILS | TEETH/<br>TANGS | SIZE MM |       |   | SIZE INCH |   |     |       |   |      |   |       |
|------------------------|-----------------|----------------------|-------------------|-----------------|---------|-------|---|-----------|---|-----|-------|---|------|---|-------|
| YZ121110               | FM9476MP        | STEEL                | -----             | 8               | EXT LG  | 317.9 | x | 159.9     | x | 1.9 | 12.52 | x | 6.3  | x | 0.075 |
| 1479110130             | FM4507          | BRONZE               | WAFFLE            | 76              | EXT TH  | 164.0 | x | 132.0     | x | 2.1 | 6.46  | x | 5.2  | x | 0.083 |
| 1479130120             | FM9082MP        | STEEL                | HARDENED          | 41              | EXT TH  | 84.5  | x | 56.0      | x | 1.0 | 3.33  | x | 2.2  | x | 0.39  |
| 1479130130             | FM4510MP        | STEEL                | -----             | 31              | INT TH  | 154.0 | x | 125.0     | x | 1.5 | 6.06  | x | 4.92 | x | 0.059 |
| <b>JOY</b>             |                 |                      |                   |                 |         |       |   |           |   |     |       |   |      |   |       |
| 10650                  | FM1776MP        | STEEL                | -----             | 6               | INT SL  | 254.0 | x | 162.3     | x | 2.3 | 10.0  | x | 6.39 | x | 0.09  |
| 15195CM                | FM1401          | BRONZE               | SPR/RAD           | 63              | EXT TH  | 273.1 | x | 188.7     | x | 2.3 | 10.75 | x | 7.43 | x | 0.09  |
| 15196CM                | FM1776MP        | STEEL                | -----             | 6               | INT SL  | 254.0 | x | 162.3     | x | 2.3 | 10.0  | x | 6.39 | x | 0.09  |
| 30752                  | FM1258MP        | OBSOLETE             | -----             | 18              | INT TH  | 220.0 | x | 159.5     | x | 1.5 | 8.66  | x | 6.28 | x | 0.06  |
| 30753                  | FM0303          | OBSOLETE AFTER STOCK |                   | 54              | EXT TH  | 235.0 | x | 166.9     | x | 2.3 | 9.25  | x | 6.57 | x | 0.09  |
| 1069446-0004           | FM1401          | BRONZE               | SPR/RAD           | 63              | EXT TH  | 273.1 | x | 188.7     | x | 2.3 | 10.75 | x | 7.43 | x | 0.09  |
| <b>JUNGHEINRICH</b>    |                 |                      |                   |                 |         |       |   |           |   |     |       |   |      |   |       |
| 8683948                | FM3604MP        | STEEL                | -----             | 35              | INT TH  | 170.9 | x | 102.9     | x | 2.5 | 6.73  | x | 4.05 | x | 0.098 |
| 8693956                | FM3602MP        | STEEL                | -----             | 35              | INT TH  | 170.9 | x | 102.9     | x | 2.0 | 6.73  | x | 4.05 | x | 0.079 |
| 8693980                | FM3594MP        | STEEL                | -----             | 29              | INT TH  | 131.1 | x | 85.1      | x | 2.0 | 5.16  | x | 3.35 | x | 0.079 |
| 8693999                | FM3596MP        | STEEL                | -----             | 29              | INT TH  | 131.1 | x | 85.1      | x | 2.5 | 5.16  | x | 3.35 | x | 0.098 |
| 8696495                | FM2279          | BRONZE               | SUNBURST          | 35              | EXT TH  | 177.5 | x | 109.0     | x | 2.0 | 6.99  | x | 4.29 | x | 0.079 |
| 8701945                | FM2277          | BRONZE               | SUNBURST          | 27              | EXT TH  | 137.4 | x | 90.9      | x | 2.0 | 5.41  | x | 3.58 | x | 0.079 |
| 50439216               | FM6149          | BRONZE               | WAFFLE            | 25              | INT TH  | 95.0  | x | 47.0      | x | 1.8 | 3.74  | x | 1.85 | x | 0.71  |
| 3150121600             | FM2943          | BRONZE               | SPR/RAD           | 42              | EXT TH  | 212.5 | x | 154.5     | x | 2.5 | 8.37  | x | 6.08 | x | 0.098 |
| 3150121700             | FM2962MP        | STEEL                | -----             | 37              | INT TH  | 204.6 | x | 143.8     | x | 2.0 | 8.06  | x | 5.66 | x | 0.079 |

| REPLACES<br>OEM PT.NO. | FMC<br>PART NO. | MATERIAL  | GROOVE<br>DETAILS | TEETH/<br>TANGS | SIZE MM    |       |   | SIZE INCH |   |     |       |   |       |   |       |
|------------------------|-----------------|-----------|-------------------|-----------------|------------|-------|---|-----------|---|-----|-------|---|-------|---|-------|
| <b>KALMAR</b>          |                 |           |                   |                 |            |       |   |           |   |     |       |   |       |   |       |
| 920624.0002            | FM1307OE        | BRONZE    | RADIAL            | 52              | INT TH     | 148.6 | x | 107.7     | x | 2.6 | 5.85  | x | 4.24  | x | 0.102 |
| 920821.0013            | FM1900MP        | STEEL     | -----             | 64              | EXT TH     | 205.5 | x | 145.3     | x | 1.7 | 8.09  | x | 5.72  | x | 0.067 |
| 920821.0014            | FM1247OE        | BRONZE    | SUNBURST          | 43              | (44)IN TH  | 196.9 | x | 137.7     | x | 2.8 | 7.75  | x | 5.42  | x | 0.109 |
| 922369.0002            | FM1324MP        | STEEL     | -----             | 54              | EXT TH     | 139.2 | x | 98.6      | x | 1.8 | 5.48  | x | 3.88  | x | 0.07  |
| 922655.0053            | FM1417          | CARBON PA | SUNBURST          | 57              | INT TH     | 303.8 | x | 235.2     | x | 3.9 | 11.96 | x | 9.26  | x | 0.153 |
| 922745.0001            | FM3167          | GRAPHITE  | WAFFLE            | 60              | INT TH     | 450.0 | x | 300.0     | x | 5.3 | 17.72 | x | 11.81 | x | 0.209 |
| 922745.0002            | FM7789          | BRONZE    | SUNBURST          | 87              | EXT TH     | 263.7 | x | 206.4     | x | 3.6 | 10.38 | x | 8.13  | x | 0.142 |
| 922746.0001            | FM1326MP        | STEEL     | -----             | 72              | (90)EX TH  | 462.0 | x | 350.0     | x | 3.5 | 18.19 | x | 13.78 | x | 0.138 |
| 922746.0002            | FM1216MP        | STEEL     | -----             | 60              | EXT TH     | 154.2 | x | 113.8     | x | 1.8 | 6.07  | x | 4.48  | x | 0.07  |
| 922746.0006            | FM8036MP        | STEEL     | -----             | 62              | INT TH     | 253.6 | x | 193.8     | x | 2.0 | 9.98  | x | 7.63  | x | 0.079 |
| 923106.0381            | FM1381OE        | BRONZE    | RADIAL            | 52              | INT TH     | 148.6 | x | 107.7     | x | 2.9 | 5.85  | x | 4.24  | x | 0.114 |
| 923109.0366            | FM2738MP        | STEEL     | -----             | 71              | EXT TH     | 182.6 | x | 117.9     | x | 1.8 | 7.19  | x | 4.64  | x | 0.069 |
| 923109.0381            | FM1381OE        | BRONZE    | RADIAL            | 52              | INT TH     | 148.6 | x | 107.7     | x | 2.9 | 5.85  | x | 4.24  | x | 0.114 |
| 923349.0531            | FM4779          | BRONZE    | SPIRAL            | 6               | EXT LG     | 122.0 | x | 72.2      | x | 1.5 | 4.8   | x | 2.84  | x | 0.059 |
| 923349.0532            | FM5978MP        | STEEL     | -----             | 19              | INT TH     | 107.0 | x | 62.5      | x | 1.5 | 4.21  | x | 2.46  | x | 0.059 |
| 923436.0789            | FM5166MP        | STEEL     | -----             | 87              | EXT TH     | 263.5 | x | 206.0     | x | 2.1 | 10.37 | x | 8.11  | x | 0.081 |
| 923436.079             | FM5163          | PAPER     | 3 PASS            | 62              | INT TH     | 253.5 | x | 193.8     | x | 3.6 | 9.98  | x | 7.63  | x | 0.14  |
| 923436.0802            | FM1660MP        | STEEL     | -----             | 45              | INT TH     | 152.4 | x | 92.5      | x | 1.6 | 6.0   | x | 3.64  | x | 0.063 |
| 923468.0193            | FM4349          | PAPER     | WAFFLE            | 42              | INT TH     | 340.0 | x | 206.0     | x | 5.5 | 13.39 | x | 8.11  | x | 0.217 |
| 923468.0194            | FM3006MP        | STEEL     | -----             | 70              | EXT TH     | 358.0 | x | 229.0     | x | 5.0 | 14.09 | x | 9.02  | x | 0.197 |
| 923468.0426            | FM2787          | GRAPHITE  | SUNBURST          | 52              | INT TH     | 175.3 | x | 106.7     | x | 2.9 | 6.9   | x | 4.2   | x | 0.114 |
| 923468.0428            | FM1216MP        | STEEL     | -----             | 60              | EXT TH     | 154.2 | x | 113.8     | x | 1.8 | 6.07  | x | 4.48  | x | 0.07  |
| 923705.0116            | FM5863          | BRONZE    | WAFFLE            | 6               | EXT LG     | 123.7 | x | 72.0      | x | 1.5 | 4.87  | x | 2.83  | x | 0.059 |
| 923705.0117            | FM6823          | BRONZE    | WAFFLE            | 24              | (27) IN TH | 88.0  | x | 53.2      | x | 1.6 | 3.46  | x | 2.09  | x | 0.063 |
| 923705.0132            | FM5863          | BRONZE    | WAFFLE            | 6               | EXT LG     | 123.7 | x | 72.0      | x | 1.5 | 4.87  | x | 2.83  | x | 0.059 |
| 923855.0246            | FM4349          | PAPER     | WAFFLE            | 42              | INT TH     | 340.0 | x | 206.0     | x | 5.5 | 13.39 | x | 8.11  | x | 0.217 |
| 923855.0748            | FM5578MP        | STEEL     | -----             | 96              | EXT TH     | 488.0 | x | 310.0     | x | 4.0 | 19.21 | x | 12.2  | x | 0.157 |
| 923855.1376            | FM6093          | AFP       | WAFFLE            | 60              | INT TH     | 450.0 | x | 300.0     | x | 5.3 | 17.72 | x | 11.81 | x | 0.209 |
| 923855.1432            | FM6435          | CARBON PA | WAFFLE            | 52              | INT TH     | 193.0 | x | 107.5     | x | 2.6 | 7.6   | x | 4.23  | x | 0.102 |
| 923855.1433            | FM6018MP        | STEEL     | -----             | 78              | EXT TH     | 200.0 | x | 114.0     | x | 3.0 | 7.87  | x | 4.49  | x | 0.118 |
| 923855.145             | FM5376MP        | STEEL     | -----             | 45              | INT TH     | 148.3 | x | 92.7      | x | 2.3 | 5.84  | x | 33.65 | x | 0.089 |
| 923855.1451            | FM6437          | CARBON PA | WAFFLE            | 60              | EXT TH     | 154.0 | x | 99.0      | x | 2.7 | 6.06  | x | 3.9   | x | 0.104 |
| 923855.1452            | FM6439          | CARBON PA | WAFFLE/PLAIN      | 60              | EXT TH     | 154.0 | x | 99.0      | x | 1.9 | 6.06  | x | 3.9   | x | 0.075 |
| 923855.1469            | FM6016MP        | STEEL     | -----             | 78              | EXT TH     | 200.0 | x | 114.0     | x | 2.3 | 7.87  | x | 4.49  | x | 0.089 |
| 923899.0004            | FM3007          | PAPER     | 3 PASS            | 60              | INT TH     | 466.0 | x | 284.0     | x | 5.6 | 18.35 | x | 11.18 | x | 0.22  |
| 923941.0537            | FM6172MP        | STEEL     | -----             | 70              | EXT TH     | 358.0 | x | 239.0     | x | 5.0 | 14.09 | x | 9.41  | x | 0.197 |
| 923944.1493            | FM5376MP        | STEEL     | -----             | 45              | INT TH     | 148.3 | x | 92.7      | x | 2.3 | 5.84  | x | 33.65 | x | 0.089 |
| 923944.1494            | FM6437          | CARBON PA | WAFFLE            | 60              | EXT TH     | 154.0 | x | 99.0      | x | 2.7 | 6.06  | x | 3.9   | x | 0.104 |
| 923944.1495            | FM6439          | CARBON PA | WAFFLE/PLAIN      | 60              | EXT TH     | 154.0 | x | 99.0      | x | 1.9 | 6.06  | x | 3.9   | x | 0.075 |
| 923976.1399            | FM6048MP        | STEEL     | -----             | 52              | EXT TH     | 167.5 | x | 114.0     | x | 2.5 | 6.59  | x | 4.49  | x | 0.098 |
| 923976.14              | FM6045          | PAPER     | WAFFLE            | 52              | INT TH     | 161.0 | x | 107.0     | x | 2.9 | 6.34  | x | 4.21  | x | 0.112 |
| 923976.2815            | FM6435          | CARBON PA | WAFFLE            | 52              | INT TH     | 193.0 | x | 107.5     | x | 2.6 | 7.6   | x | 4.23  | x | 0.102 |
| 923976.2816            | FM6437          | CARBON PA | WAFFLE            | 60              | EXT TH     | 154.0 | x | 99.0      | x | 2.7 | 6.06  | x | 3.9   | x | 0.104 |
| 923976.2817            | FM6439          | CARBON PA | WAFFLE/PLAIN      | 60              | EXT TH     | 154.0 | x | 99.0      | x | 1.9 | 6.06  | x | 3.9   | x | 0.075 |
| 924015.0287            | FM5865          | PAPER     | WAFFLE            | 45              | INT TH     | 340.0 | x | 221.0     | x | 4.1 | 13.39 | x | 8.7   | x | 0.161 |
| 924015.1203            | FM6823          | BRONZE    | WAFFLE            | 24              | (27) IN TH | 88.0  | x | 53.2      | x | 1.6 | 3.46  | x | 2.09  | x | 0.063 |
| 924015.1204            | FM5863          | BRONZE    | WAFFLE            | 6               | EXT LG     | 123.7 | x | 72.0      | x | 1.5 | 4.87  | x | 2.83  | x | 0.059 |

| REPLACES OEM PT.NO. | FMC PART NO. | MATERIAL | GROOVE DETAILS | TEETH/TANGS | SIZE MM   |       |   | SIZE INCH |   |     |       |   |       |   |       |
|---------------------|--------------|----------|----------------|-------------|-----------|-------|---|-----------|---|-----|-------|---|-------|---|-------|
| 801903488           | FM2896MP     | STEEL    | -----          | 142         | EXT TH    | 455.0 | x | 342.0     | x | 4.0 | 17.91 | x | 13.46 | x | 0.157 |
| 801903489           | FM3659       | PAPER    | 4 PASS/WAG     | 104         | INT TH    | 437.9 | x | 325.1     | x | 5.0 | 17.24 | x | 12.8  | x | 0.197 |
| 802308777           | FM1326MP     | STEEL    | -----          | 72          | (90)EX TH | 462.0 | x | 350.0     | x | 3.5 | 18.19 | x | 13.78 | x | 0.138 |
| 802308779           | FM4642MP     | STEEL    | -----          | 72          | (90)EX TH | 462.0 | x | 350.0     | x | 5.0 | 18.19 | x | 13.78 | x | 0.197 |
| 802309501           | FM6093       | AFP      | WAFFLE         | 60          | INT TH    | 450.0 | x | 300.0     | x | 5.3 | 17.72 | x | 11.81 | x | 0.209 |
| 802310716           | FM3007       | PAPER    | 3 PASS         | 60          | INT TH    | 466.0 | x | 284.0     | x | 5.6 | 18.35 | x | 11.18 | x | 0.22  |
| 802311013           | FM4349       | PAPER    | WAFFLE         | 42          | INT TH    | 340.0 | x | 206.0     | x | 5.5 | 13.39 | x | 8.11  | x | 0.217 |
| 802311014           | FM3006MP     | STEEL    | -----          | 70          | EXT TH    | 358.0 | x | 229.0     | x | 5.0 | 14.09 | x | 9.02  | x | 0.197 |
| N2219018H           | FM5167       | PAPER    | 3 PASS         | 63          | INT TH    | 435.0 | x | 252.0     | x | 6.7 | 17.13 | x | 9.92  | x | 0.262 |
| N2220119H           | FM5258MP     | STEEL    | -----          | 12          | EXT LG    | 453.0 | x | 298.0     | x | 5.0 | 17.83 | x | 11.73 | x | 0.197 |

### KALMAR CLIMAX (ALSO SEE BROCKHOUSE AND GRAZIANO)

|            |          |                      |        |    |        |       |   |       |   |     |      |   |      |   |       |
|------------|----------|----------------------|--------|----|--------|-------|---|-------|---|-----|------|---|------|---|-------|
| DV 38410/1 | FM0855   | OBSOLETE AFTER STOCK |        | 38 | INT TH | 162.6 | x | 120.9 | x | 2.3 | 6.4  | x | 4.76 | x | 0.09  |
| 113-667    | FM1389   | BRONZE               | SPIRAL | 57 | INT TH | 128.3 | x | 87.9  | x | 2.5 | 5.05 | x | 3.46 | x | 0.098 |
| 113-668    | FM1302MP | STEEL                | -----  | 64 | EXT TH | 137.2 | x | 96.3  | x | 1.5 | 5.4  | x | 3.79 | x | 0.059 |
| 119-251    | FM1324MP | STEEL                | -----  | 54 | EXT TH | 139.2 | x | 98.6  | x | 1.8 | 5.48 | x | 3.88 | x | 0.07  |

### KATO

|              |          |       |        |    |        |       |   |       |   |     |      |   |      |   |       |
|--------------|----------|-------|--------|----|--------|-------|---|-------|---|-----|------|---|------|---|-------|
| KR45H        | FM3360MP | STEEL | -----  | 64 | EXT TH | 164.3 | x | 107.0 | x | 2.0 | 6.47 | x | 4.21 | x | 0.079 |
| KR45H        | FM3361   | PAPER | WAFFLE | 38 | INT TH | 158.0 | x | 95.2  | x | 2.7 | 6.22 | x | 3.75 | x | 0.106 |
| 203-21011201 | FM4270MP | STEEL | -----  | 70 | EXT TH | 180.0 | x | 120.0 | x | 2.0 | 7.09 | x | 4.72 | x | 0.079 |
| 203-21012201 | FM4267   | PAPER | 2 PASS | 44 | INT TH | 173.0 | x | 110.0 | x | 3.0 | 6.81 | x | 4.33 | x | 0.118 |
| 203-21012202 | FM4267   | PAPER | 2 PASS | 44 | INT TH | 173.0 | x | 110.0 | x | 3.0 | 6.81 | x | 4.33 | x | 0.118 |
| 303-21412000 | FM1476MP | STEEL | -----  | 64 | EXT TH | 164.1 | x | 107.2 | x | 1.5 | 6.46 | x | 4.22 | x | 0.06  |
| 303-21413000 | FM1477   | PAPER | 2 PASS | 38 | INT TH | 157.7 | x | 95.3  | x | 2.3 | 6.21 | x | 3.75 | x | 0.09  |
| 303-2449800  | FM4323   | PAPER | 2 PASS | 33 | INT TH | 100.0 | x | 66.0  | x | 3.0 | 3.94 | x | 2.6  | x | 0.118 |
| ?            | FM4326MP | STEEL | -----  | 4  | EXT LG | 111.3 | x | 73.0  | x | 2.0 | 4.38 | x | 2.88 | x | 0.079 |

### KAWASAKI

|             |          |                      |        |    |           |       |   |       |   |     |       |   |       |   |       |
|-------------|----------|----------------------|--------|----|-----------|-------|---|-------|---|-----|-------|---|-------|---|-------|
| 24690-0008C | FM7096MP | STEEL                | -----  | 8  | EXT LG    | 163.7 | x | 139.0 | x | 1.7 | 6.44  | x | 5.47  | x | 0.067 |
| 24730-0008C | FM7093   | PAPER                | 2 PASS | 43 | INT TH    | 155.0 | x | 129.4 | x | 2.0 | 6.1   | x | 5.09  | x | 0.079 |
| 37200-20020 | FM6758MP | STEEL                | -----  | 4  | INT LG    | 283.2 | x | 168.5 | x | 6.0 | 11.15 | x | 6.63  | x | 0.236 |
| 37212-20050 | FM4972MP | STEEL                | -----  | 52 | (78)EX TH | 404.0 | x | 255.0 | x | 4.9 | 15.91 | x | 10.04 | x | 0.193 |
| 37212-20080 | FM4974MP | STEEL                | -----  | 48 | (78)EX TH | 404.0 | x | 255.0 | x | 4.9 | 15.91 | x | 10.04 | x | 0.193 |
| 37212-20110 | FM4974MP | STEEL                | -----  | 48 | (78)EX TH | 404.0 | x | 255.0 | x | 4.9 | 15.91 | x | 10.04 | x | 0.193 |
| 37212-20140 | FM5504MP | OBSOLETE AFTER STOCK |        | 4  | INT LG    | 304.0 | x | 168.0 | x | 8.0 | 11.97 | x | 6.61  | x | 0.315 |
| 37212-20160 | FM4972MP | STEEL                | -----  | 52 | (78)EX TH | 404.0 | x | 255.0 | x | 4.9 | 15.91 | x | 10.04 | x | 0.193 |
| 37212-20170 | FM4974MP | STEEL                | -----  | 48 | (78)EX TH | 404.0 | x | 255.0 | x | 4.9 | 15.91 | x | 10.04 | x | 0.193 |
| 37212-20180 | FM4974MP | STEEL                | -----  | 48 | (78)EX TH | 404.0 | x | 255.0 | x | 4.9 | 15.91 | x | 10.04 | x | 0.193 |
| 37212-20210 | FM6180MP | STEEL                | -----  | 36 | (74)EX TH | 496.0 | x | 275.0 | x | 5.0 | 19.53 | x | 10.83 | x | 0.197 |
| 37212-20220 | FM6616MP | STEEL                | -----  | 38 | (74)EX TH | 496.0 | x | 275.0 | x | 5.0 | 19.53 | x | 10.83 | x | 0.197 |
| 37212-20270 | FM1562MP | STEEL                | -----  | 85 | EXT TH    | 181.4 | x | 112.8 | x | 1.7 | 7.14  | x | 4.44  | x | 0.066 |
| 37212-20280 | FM3710MP | STEEL                | -----  | 85 | EXT TH    | 181.4 | x | 112.8 | x | 2.3 | 7.14  | x | 4.44  | x | 0.09  |
| 37212-20290 | FM2968MP | STEEL                | -----  | 6  | EXT LG    | 295.0 | x | 225.0 | x | 2.7 | 11.61 | x | 8.86  | x | 0.106 |
| 37212-20320 | FM2018MP | STEEL                | -----  | 12 | EXT LG    | 165.6 | x | 100.1 | x | 2.0 | 6.52  | x | 3.94  | x | 0.079 |
| 37212-20340 | FM3442MP | STEEL                | -----  | 95 | EXT TH    | 202.0 | x | 133.0 | x | 2.5 | 7.95  | x | 5.24  | x | 0.098 |
| 37212-20360 | FM4256MP | STEEL                | -----  | 85 | EXT TH    | 181.5 | x | 116.0 | x | 1.8 | 7.15  | x | 4.57  | x | 0.071 |

| REPLACES<br>OEM PT.NO. | FMC<br>PART NO. | MATERIAL             | GROOVE<br>DETAILS | TEETH/<br>TANGS | SIZE MM |       |   | SIZE INCH |   |     |       |   |      |   |       |
|------------------------|-----------------|----------------------|-------------------|-----------------|---------|-------|---|-----------|---|-----|-------|---|------|---|-------|
| 37212-60030            | FM4316MP        | STEEL                | -----             | 12              | EXT LG  | 221.5 | x | 135.0     | x | 2.3 | 8.72  | x | 5.31 | x | 0.091 |
| 37212-60040            | FM5490MP        | STEEL                | -----             | 47              | EXT TH  | 146.0 | x | 90.0      | x | 1.8 | 5.75  | x | 3.54 | x | 0.071 |
| 37212-60130            | FM4396MP        | STEEL                | -----             | 43              | EXT TH  | 219.0 | x | 144.9     | x | 2.3 | 8.62  | x | 5.7  | x | 0.091 |
| 37212-60150            | FM3360MP        | STEEL                | -----             | 64              | EXT TH  | 164.3 | x | 107.0     | x | 2.0 | 6.47  | x | 4.21 | x | 0.079 |
| 37212-60160            | FM4270MP        | STEEL                | -----             | 70              | EXT TH  | 180.0 | x | 120.0     | x | 2.0 | 7.09  | x | 4.72 | x | 0.079 |
| 37213-20020            | FM5501          | PAPER                | 2 PASS            | 16              | INT TH  | 298.0 | x | 56.0      | x | 9.3 | 11.73 | x | 2.2  | x | 0.364 |
| 37213-20160            | FM5309          | PAPER                | 2 PASS            | 24              | INT TH  | 374.6 | x | 109.6     | x | 7.0 | 14.75 | x | 4.31 | x | 0.276 |
| 37213-20170            | FM3925          | PAPER                | 2 PASS            | 32              | INT TH  | 400.0 | x | 150.0     | x | 7.0 | 15.75 | x | 5.91 | x | 0.275 |
| 37213-20171            | FM3925          | PAPER                | 2 PASS            | 32              | INT TH  | 400.0 | x | 150.0     | x | 7.0 | 15.75 | x | 5.91 | x | 0.275 |
| 37213-20180            | FM5307          | PAPER                | 2 PASS            | 32              | INT TH  | 429.3 | x | 150.0     | x | 7.0 | 16.9  | x | 5.91 | x | 0.275 |
| 37213-20190            | FM3443          | PAPER                | 2 PASS            | 24              | INT TH  | 375.0 | x | 110.0     | x | 7.4 | 14.76 | x | 4.33 | x | 0.291 |
| 37213-20300            | FM4033          | PAPER                | 2 PASS            | 34              | INT TH  | 167.6 | x | 104.6     | x | 1.8 | 6.6   | x | 4.12 | x | 0.07  |
| 37213-20330            | FM3525          | BRONZE               | SUNBURST          | 50              | INT TH  | 209.5 | x | 120.4     | x | 3.2 | 8.25  | x | 4.74 | x | 0.125 |
| 37213-20340            | FM3937          | BRONZE               | SUNBURST          | 56              | INT TH  | 238.1 | x | 162.3     | x | 4.0 | 9.37  | x | 6.39 | x | 0.157 |
| 37213-20370            | FM3711          | BRONZE               | SUNBURST          | 37              | INT TH  | 155.7 | x | 87.9      | x | 2.6 | 6.13  | x | 3.46 | x | 0.102 |
| 37213-20390            | FM6881          | OBSOLETE             | SPR/RAD           | 56              | INT TH  | 252.0 | x | 162.0     | x | 4.0 | 9.92  | x | 6.38 | x | 0.157 |
| 37213-20410            | FM2965          | BRONZE               | SUNBURST          | 68              | INT TH  | 270.0 | x | 212.0     | x | 3.9 | 10.63 | x | 8.35 | x | 0.154 |
| 37213-20420            | FM4393          | BRONZE               | SUNBURST          | 54              | INT TH  | 209.0 | x | 130.3     | x | 3.3 | 8.23  | x | 5.13 | x | 0.128 |
| 37213-20600            | FM3361          | PAPER                | WAFFLE            | 38              | INT TH  | 158.0 | x | 95.2      | x | 2.7 | 6.22  | x | 3.75 | x | 0.106 |
| 37213-60020            | FM4969          | PAPER                | 2 PASS            | 24              | INT TH  | 375.0 | x | 110.0     | x | 7.2 | 14.76 | x | 4.33 | x | 0.283 |
| 37213-60090            | FM5573          | PAPER                | 2 PASS            | 16              | INT TH  | 278.0 | x | 54.0      | x | 8.7 | 10.94 | x | 2.13 | x | 0.343 |
| 37213-60130            | FM3239          | PAPER                | WAFFLE            | 34              | INT TH  | 167.6 | x | 105.0     | x | 2.0 | 6.6   | x | 4.13 | x | 0.08  |
| 37213-60140            | FM3251          | PAPER                | WAFFLE            | 40              | INT TH  | 191.9 | x | 124.1     | x | 3.3 | 7.55  | x | 4.88 | x | 0.129 |
| 37213-60150            | FM3251          | PAPER                | WAFFLE            | 40              | INT TH  | 191.9 | x | 124.1     | x | 3.3 | 7.55  | x | 4.88 | x | 0.129 |
| 37213-60160            | FM3561          | PAPER                | WAFFLE            | 30              | INT TH  | 131.0 | x | 79.2      | x | 2.6 | 5.16  | x | 3.12 | x | 0.102 |
| 37213-60260            | FM5573          | PAPER                | 2 PASS            | 16              | INT TH  | 278.0 | x | 54.0      | x | 8.7 | 10.94 | x | 2.13 | x | 0.343 |
| 37213-60280            | FM3443          | PAPER                | 2 PASS            | 24              | INT TH  | 375.0 | x | 110.0     | x | 7.4 | 14.76 | x | 4.33 | x | 0.291 |
| 37213-60340            | FM5169          | BRONZE               | SUNBURST          | 95              | INT TH  | 359.7 | x | 279.4     | x | 4.0 | 14.16 | x | 11.0 | x | 0.157 |
| 37213-60360            | FM3361          | PAPER                | WAFFLE            | 38              | INT TH  | 158.0 | x | 95.2      | x | 2.7 | 6.22  | x | 3.75 | x | 0.106 |
| 37213-60370            | FM4267          | PAPER                | 2 PASS            | 44              | INT TH  | 173.0 | x | 110.0     | x | 3.0 | 6.81  | x | 4.33 | x | 0.118 |
| 37213-60380            | FM3361          | PAPER                | WAFFLE            | 38              | INT TH  | 158.0 | x | 95.2      | x | 2.7 | 6.22  | x | 3.75 | x | 0.106 |
| 37213-60390            | FM3361          | PAPER                | WAFFLE            | 38              | INT TH  | 158.0 | x | 95.2      | x | 2.7 | 6.22  | x | 3.75 | x | 0.106 |
| 37213-60400            | FM2135          | PAPER                | 2 PASS            | 38              | INT TH  | 133.6 | x | 77.0      | x | 2.8 | 5.26  | x | 3.03 | x | 0.11  |
| 37213-60410            | FM2135          | PAPER                | 2 PASS            | 38              | INT TH  | 133.6 | x | 77.0      | x | 2.8 | 5.26  | x | 3.03 | x | 0.11  |
| 37213-60450            | FM4267          | PAPER                | 2 PASS            | 44              | INT TH  | 173.0 | x | 110.0     | x | 3.0 | 6.81  | x | 4.33 | x | 0.118 |
| 37213-60460            | FM3361          | PAPER                | WAFFLE            | 38              | INT TH  | 158.0 | x | 95.2      | x | 2.7 | 6.22  | x | 3.75 | x | 0.106 |
| 37213-60540            | FM3925          | PAPER                | 2 PASS            | 32              | INT TH  | 400.0 | x | 150.0     | x | 7.0 | 15.75 | x | 5.91 | x | 0.275 |
| 37213-60590            | FM5501          | PAPER                | 2 PASS            | 16              | INT TH  | 298.0 | x | 56.0      | x | 9.3 | 11.73 | x | 2.2  | x | 0.364 |
| 37213-60630            | FM4969          | PAPER                | 2 PASS            | 24              | INT TH  | 375.0 | x | 110.0     | x | 7.2 | 14.76 | x | 4.33 | x | 0.283 |
| 37213-60640            | FM5573          | PAPER                | 2 PASS            | 16              | INT TH  | 278.0 | x | 54.0      | x | 8.7 | 10.94 | x | 2.13 | x | 0.343 |
| 41621-20640            | FM5504MP        | OBSOLETE AFTER STOCK |                   | 4               | INT LG  | 304.0 | x | 168.0     | x | 8.0 | 11.97 | x | 6.61 | x | 0.315 |
| 52101-01440            | FM4033          | PAPER                | 2 PASS            | 34              | INT TH  | 167.6 | x | 104.6     | x | 1.8 | 6.6   | x | 4.12 | x | 0.07  |
| 52101-01450            | FM3710MP        | STEEL                | -----             | 85              | EXT TH  | 181.4 | x | 112.8     | x | 2.3 | 7.14  | x | 4.44 | x | 0.09  |
| 52101-02290            | FM4969          | PAPER                | 2 PASS            | 24              | INT TH  | 375.0 | x | 110.0     | x | 7.2 | 14.76 | x | 4.33 | x | 0.283 |
| 52101-07280            | FM3710MP        | STEEL                | -----             | 85              | EXT TH  | 181.4 | x | 112.8     | x | 2.3 | 7.14  | x | 4.44 | x | 0.09  |
| 52201-00140            | FM4256MP        | STEEL                | -----             | 85              | EXT TH  | 181.5 | x | 116.0     | x | 1.8 | 7.15  | x | 4.57 | x | 0.071 |
| 52201-04720            | FM3239          | PAPER                | WAFFLE            | 34              | INT TH  | 167.6 | x | 105.0     | x | 2.0 | 6.6   | x | 4.13 | x | 0.08  |

| REPLACES<br>OEM PT.NO. | FMC<br>PART NO. | MATERIAL | GROOVE<br>DETAILS | TEETH/<br>TANGS | SIZE MM |       |   | SIZE INCH |   |     |       |   |       |   |       |
|------------------------|-----------------|----------|-------------------|-----------------|---------|-------|---|-----------|---|-----|-------|---|-------|---|-------|
| 52201-06390            | FM3251          | PAPER    | WAFFLE            | 40              | INT TH  | 191.9 | x | 124.1     | x | 3.3 | 7.55  | x | 4.88  | x | 0.129 |
| 52201-06400            | FM3442MP        | STEEL    | -----             | 95              | EXT TH  | 202.0 | x | 133.0     | x | 2.5 | 7.95  | x | 5.24  | x | 0.098 |
| 52201-09150            | FM3251          | PAPER    | WAFFLE            | 40              | INT TH  | 191.9 | x | 124.1     | x | 3.3 | 7.55  | x | 4.88  | x | 0.129 |
| 52301-00540            | FM3361          | PAPER    | WAFFLE            | 38              | INT TH  | 158.0 | x | 95.2      | x | 2.7 | 6.22  | x | 3.75  | x | 0.106 |
| 52301-00550            | FM3360MP        | STEEL    | -----             | 64              | EXT TH  | 164.3 | x | 107.0     | x | 2.0 | 6.47  | x | 4.21  | x | 0.079 |
| 52301-04030            | FM4270MP        | STEEL    | -----             | 70              | EXT TH  | 180.0 | x | 120.0     | x | 2.0 | 7.09  | x | 4.72  | x | 0.079 |
| 602894-104             | FM1844MP        | STEEL    | -----             | 8               | EXT LG  | 134.4 | x | 81.0      | x | 1.6 | 5.29  | x | 3.19  | x | 0.063 |
| YS 0610 010 900        | FM6881          | OBSOLETE | SPR/RAD           | 56              | INT TH  | 252.0 | x | 162.0     | x | 4.0 | 9.92  | x | 6.38  | x | 0.157 |
| YS 584 020 262         | FM2968MP        | STEEL    | -----             | 6               | EXT LG  | 295.0 | x | 225.0     | x | 2.7 | 11.61 | x | 8.86  | x | 0.106 |
| YS 584 990 840         | FM2965          | BRONZE   | SUNBURST          | 68              | INT TH  | 270.0 | x | 212.0     | x | 3.9 | 10.63 | x | 8.35  | x | 0.154 |
| YS 608 040 961         | FM4457          | BRONZE   | SUNBURST          | 77              | INT TH  | 300.0 | x | 239.0     | x | 4.0 | 11.81 | x | 9.41  | x | 0.157 |
| YK 1158 310 300        | FM2018MP        | STEEL    | -----             | 12              | EXT LG  | 165.6 | x | 100.1     | x | 2.0 | 6.52  | x | 3.94  | x | 0.079 |
| 1168 300 900           | FM5813          | PAPER    | 2 PASS            | 43              | INT TH  | 173.8 | x | 103.0     | x | 2.5 | 6.84  | x | 4.06  | x | 0.098 |
| YS 1188 300 400        | FM3525          | BRONZE   | SUNBURST          | 50              | INT TH  | 209.5 | x | 120.4     | x | 3.2 | 8.25  | x | 4.74  | x | 0.125 |
| 1188 300 510           | FM3525          | BRONZE   | SUNBURST          | 50              | INT TH  | 209.5 | x | 120.4     | x | 3.2 | 8.25  | x | 4.74  | x | 0.125 |
| 1188 300 800           | FM3525          | BRONZE   | SUNBURST          | 50              | INT TH  | 209.5 | x | 120.4     | x | 3.2 | 8.25  | x | 4.74  | x | 0.125 |
| 1188 310 200           | FM4316MP        | STEEL    | -----             | 12              | EXT LG  | 221.5 | x | 135.0     | x | 2.3 | 8.72  | x | 5.31  | x | 0.091 |
| YK 1188 310 400        | FM4316MP        | STEEL    | -----             | 12              | EXT LG  | 221.5 | x | 135.0     | x | 2.3 | 8.72  | x | 5.31  | x | 0.091 |
| YK 1188 310 510        | FM4393          | BRONZE   | SUNBURST          | 54              | INT TH  | 209.0 | x | 130.3     | x | 3.3 | 8.23  | x | 5.13  | x | 0.128 |
| YK 1208 300 400        | FM3937          | BRONZE   | SUNBURST          | 56              | INT TH  | 238.1 | x | 162.3     | x | 4.0 | 9.37  | x | 6.39  | x | 0.157 |
| 1208 300 510           | FM3937          | BRONZE   | SUNBURST          | 56              | INT TH  | 238.1 | x | 162.3     | x | 4.0 | 9.37  | x | 6.39  | x | 0.157 |
| YK 1208 310 200        | FM4346MP        | STEEL    | -----             | 12              | EXT LG  | 247.0 | x | 179.0     | x | 2.3 | 9.72  | x | 7.05  | x | 0.091 |
| <b>KESSLER</b>         |                 |          |                   |                 |         |       |   |           |   |     |       |   |       |   |       |
| 140-244-047            | FM3007          | PAPER    | 3 PASS            | 60              | INT TH  | 466.0 | x | 284.0     | x | 5.6 | 18.35 | x | 11.18 | x | 0.22  |
| 140-244-069            | FM4404MP        | STEEL    | -----             | 96              | EXT TH  | 488.0 | x | 310.0     | x | 3.5 | 19.21 | x | 12.2  | x | 0.138 |
| 507-275-223            | FM3006MP        | STEEL    | -----             | 70              | EXT TH  | 358.0 | x | 229.0     | x | 5.0 | 14.09 | x | 9.02  | x | 0.197 |
| 507-275-293            | FM4349          | PAPER    | WAFFLE            | 42              | INT TH  | 340.0 | x | 206.0     | x | 5.5 | 13.39 | x | 8.11  | x | 0.217 |
| 507-275-303            | FM3010MP        | STEEL    | -----             | 96              | EXT TH  | 488.0 | x | 310.0     | x | 6.0 | 19.21 | x | 12.2  | x | 0.236 |
| 507-275-343            | FM3007          | PAPER    | 3 PASS            | 60              | INT TH  | 466.0 | x | 284.0     | x | 5.6 | 18.35 | x | 11.18 | x | 0.22  |
| 507-275-673            | FM4349          | PAPER    | WAFFLE            | 42              | INT TH  | 340.0 | x | 206.0     | x | 5.5 | 13.39 | x | 8.11  | x | 0.217 |
| 507-275-723            | FM3007          | PAPER    | 3 PASS            | 60              | INT TH  | 466.0 | x | 284.0     | x | 5.6 | 18.35 | x | 11.18 | x | 0.22  |
| 507-275-773            | FM5578MP        | STEEL    | -----             | 96              | EXT TH  | 488.0 | x | 310.0     | x | 4.0 | 19.21 | x | 12.2  | x | 0.157 |
| 507-275-773b           | FM4404MP        | STEEL    | -----             | 96              | EXT TH  | 488.0 | x | 310.0     | x | 3.5 | 19.21 | x | 12.2  | x | 0.138 |
| 507-275-843            | FM4349          | PAPER    | WAFFLE            | 42              | INT TH  | 340.0 | x | 206.0     | x | 5.5 | 13.39 | x | 8.11  | x | 0.217 |
| 507-275-883            | FM4351          | PAPER    | WAFFLE            | 60              | INT TH  | 465.8 | x | 284.4     | x | 5.6 | 18.34 | x | 11.2  | x | 0.22  |
| 507-275-913            | FM5865          | PAPER    | WAFFLE            | 45              | INT TH  | 340.0 | x | 221.0     | x | 4.1 | 13.39 | x | 8.7   | x | 0.161 |
| 507-275-923            | FM6172MP        | STEEL    | -----             | 70              | EXT TH  | 358.0 | x | 239.0     | x | 5.0 | 14.09 | x | 9.41  | x | 0.197 |
| 507-275-943            | FM8169          | PAPER    | WAFFLE            | 62              | INT TH  | 465.5 | x | 292.3     | x | 5.6 | 18.32 | x | 11.51 | x | 0.141 |
| 507-275-952            | FM8172MP        | STEEL    | -----             | 24              | EXT LG  | 485.9 | x | 310.1     | x | 4.0 | 19.13 | x | 12.21 | x | 0.157 |
| 507-275-1023           | FM8061          | PAPER    | WAFFLE            | 79              | INT TH  | 550.0 | x | 391.0     | x | 5.5 | 21.65 | x | 15.39 | x | 0.217 |
| 507-275-1032           | FM8064MP        | STEEL    | -----             | 24              | EXT TH  | 570.0 | x | 416.0     | x | 4.0 | 22.44 | x | 16.38 | x | 0.157 |
| <b>K.H.D.</b>          |                 |          |                   |                 |         |       |   |           |   |     |       |   |       |   |       |
| 234 7828               | FM2679          | BRONZE   | SPR/RAD           | 62              | EXT TH  | 188.0 | x | 132.0     | x | 2.4 | 7.4   | x | 5.2   | x | 0.094 |
| 234 7831               | FM2682MP        | STEEL    | -----             | 41              | INT TH  | 178.0 | x | 119.0     | x | 2.3 | 7.01  | x | 4.69  | x | 0.091 |

| REPLACES<br>OEM PT.NO. | FMC<br>PART NO. | MATERIAL | GROOVE<br>DETAILS | TEETH/<br>TANGS | SIZE MM    |       |   | SIZE INCH |   |     |       |   |       |   |       |
|------------------------|-----------------|----------|-------------------|-----------------|------------|-------|---|-----------|---|-----|-------|---|-------|---|-------|
| <b>KIRKSTALL</b>       |                 |          |                   |                 |            |       |   |           |   |     |       |   |       |   |       |
| R2037/211B             | FM3747          | BRONZE   | SPR/RAD           | 104             | INT TH     | 437.9 | x | 325.1     | x | 4.3 | 17.24 | x | 12.8  | x | 0.169 |
| R2090/211A             | FM3659          | PAPER    | 4 PASS/WAG        | 104             | INT TH     | 437.9 | x | 325.1     | x | 5.0 | 17.24 | x | 12.8  | x | 0.197 |
| R9296/210A             | FM2896MP        | STEEL    | -----             | 142             | EXT TH     | 455.0 | x | 342.0     | x | 4.0 | 17.91 | x | 13.46 | x | 0.157 |
| R9296/210B             | FM3750MP        | STEEL    | -----             | 142             | EXT TH     | 455.0 | x | 342.0     | x | 3.2 | 17.91 | x | 13.46 | x | 0.126 |
| R9296/211A             | FM3659          | PAPER    | 4 PASS/WAG        | 104             | INT TH     | 437.9 | x | 325.1     | x | 5.0 | 17.24 | x | 12.8  | x | 0.197 |
| <b>KOBELCO</b>         |                 |          |                   |                 |            |       |   |           |   |     |       |   |       |   |       |
| 0335-01075-1           | FM3239          | PAPER    | WAFFLE            | 34              | INT TH     | 167.6 | x | 105.0     | x | 2.0 | 6.6   | x | 4.13  | x | 0.08  |
| 0611-01008-0           | FM4256MP        | STEEL    | -----             | 85              | EXT TH     | 181.5 | x | 116.0     | x | 1.8 | 7.15  | x | 4.57  | x | 0.071 |
| 0612-01044-0           | FM3239          | PAPER    | WAFFLE            | 34              | INT TH     | 167.6 | x | 105.0     | x | 2.0 | 6.6   | x | 4.13  | x | 0.08  |
| 0614-30279-0           | FM3239          | PAPER    | WAFFLE            | 34              | INT TH     | 167.6 | x | 105.0     | x | 2.0 | 6.6   | x | 4.13  | x | 0.08  |
| 0616-30073-0           | FM4274MP        | STEEL    | -----             | 61              | EXT TH     | 131.2 | x | 99.0      | x | 1.8 | 5.17  | x | 3.9   | x | 0.071 |
| 0616-30074-0           | FM4271          | PAPER    | 2 PASS            | 45              | INT TH     | 125.5 | x | 93.3      | x | 2.1 | 4.94  | x | 3.67  | x | 0.084 |
| 37212-20270            | FM1562MP        | STEEL    | -----             | 85              | EXT TH     | 181.4 | x | 112.8     | x | 1.7 | 7.14  | x | 4.44  | x | 0.066 |
| 37212-20280            | FM3710MP        | STEEL    | -----             | 85              | EXT TH     | 181.4 | x | 112.8     | x | 2.3 | 7.14  | x | 4.44  | x | 0.09  |
| 37213-20370            | FM3711          | BRONZE   | SUNBURST          | 37              | INT TH     | 155.7 | x | 87.9      | x | 2.6 | 6.13  | x | 3.46  | x | 0.102 |
| 37213-20410            | FM2965          | BRONZE   | SUNBURST          | 68              | INT TH     | 270.0 | x | 212.0     | x | 3.9 | 10.63 | x | 8.35  | x | 0.154 |
| 52101-01450            | FM3710MP        | STEEL    | -----             | 85              | EXT TH     | 181.4 | x | 112.8     | x | 2.3 | 7.14  | x | 4.44  | x | 0.09  |
| 24100U110S11           | FM2463          | PAPER    | 2 PASS            | 38              | INT TH     | 154.7 | x | 95.0      | x | 3.7 | 6.09  | x | 3.74  | x | 0.144 |
| 2415P237               | FM6002MP        | STEEL    | -----             | 8               | EXT SL     | 161.0 | x | 103.0     | x | 2.3 | 6.34  | x | 4.06  | x | 0.091 |
| 2415R156               | FM5337          | PAPER    | 2 PASS            | 51              | INT TH     | 134.8 | x | 94.9      | x | 2.2 | 5.31  | x | 3.73  | x | 0.087 |
| 2415U137S1             | FM3239          | PAPER    | WAFFLE            | 34              | INT TH     | 167.6 | x | 105.0     | x | 2.0 | 6.6   | x | 4.13  | x | 0.08  |
| 2415U154S5             | FM3239          | PAPER    | WAFFLE            | 34              | INT TH     | 167.6 | x | 105.0     | x | 2.0 | 6.6   | x | 4.13  | x | 0.08  |
| 2441U783S5             | FM4855          | PAPER    | 2 PASS            | 62              | INT TH     | 178.5 | x | 148.5     | x | 2.6 | 7.03  | x | 5.85  | x | 0.102 |
| 2441U783S7             | FM4858MP        | STEEL    | -----             | 6               | EXT LG     | 193.0 | x | 162.0     | x | 2.0 | 7.6   | x | 6.38  | x | 0.079 |
| 2441U785S742           | FM3395P         | PAPER    | 2 PASS            | 56              | (60)INT TH | 180.0 | x | 145.0     | x | 4.0 | 7.09  | x | 5.71  | x | 0.157 |
| 2441U785S743           | FM3398MP        | STEEL    | -----             | 12              | EXT LG     | 188.5 | x | 158.0     | x | 1.5 | 7.42  | x | 6.22  | x | 0.059 |
| 2441U983S126           | FM7314MP        | STEEL    | -----             | 4               | EXT LG     | 220.7 | x | 189.4     | x | 2.9 | 8.69  | x | 7.46  | x | 0.114 |
| 2453U262S15            | FM4256MP        | STEEL    | -----             | 85              | EXT TH     | 181.5 | x | 116.0     | x | 1.8 | 7.15  | x | 4.57  | x | 0.071 |
| 2453U297S10            | FM4274MP        | STEEL    | -----             | 61              | EXT TH     | 131.2 | x | 99.0      | x | 1.8 | 5.17  | x | 3.9   | x | 0.071 |
| 2453U297S11            | FM4271          | PAPER    | 2 PASS            | 45              | INT TH     | 125.5 | x | 93.3      | x | 2.1 | 4.94  | x | 3.67  | x | 0.084 |
| 953S6                  | FM7093          | PAPER    | 2 PASS            | 43              | INT TH     | 155.0 | x | 129.4     | x | 2.0 | 6.1   | x | 5.09  | x | 0.079 |
| 954S6                  | FM7096MP        | STEEL    | -----             | 8               | EXT LG     | 163.7 | x | 139.0     | x | 1.7 | 6.44  | x | 5.47  | x | 0.067 |
| EZ03P01004S16          | FM7253          | PAPER    | 2 PASS            | 51              | INT TH     | 139.9 | x | 95.0      | x | 2.2 | 5.51  | x | 3.74  | x | 0.087 |
| LQ15V00020S051         | FM7311          | PAPER    | 2 PASS            | 30              | (38)INT TH | 207.0 | x | 148.0     | x | 3.6 | 8.15  | x | 5.83  | x | 0.14  |
| VB0335-01075-1         | FM3239          | PAPER    | WAFFLE            | 34              | INT TH     | 167.6 | x | 105.0     | x | 2.0 | 6.6   | x | 4.13  | x | 0.08  |
| VB0611-01008-0         | FM4256MP        | STEEL    | -----             | 85              | EXT TH     | 181.5 | x | 116.0     | x | 1.8 | 7.15  | x | 4.57  | x | 0.071 |
| VB0612-01044-0         | FM3239          | PAPER    | WAFFLE            | 34              | INT TH     | 167.6 | x | 105.0     | x | 2.0 | 6.6   | x | 4.13  | x | 0.08  |
| VB0614-30192-0         | FM3239          | PAPER    | WAFFLE            | 34              | INT TH     | 167.6 | x | 105.0     | x | 2.0 | 6.6   | x | 4.13  | x | 0.08  |
| VB0614-30278-0         | FM7253          | PAPER    | 2 PASS            | 51              | INT TH     | 139.9 | x | 95.0      | x | 2.2 | 5.51  | x | 3.74  | x | 0.087 |
| VB0614-30279-0         | FM3239          | PAPER    | WAFFLE            | 34              | INT TH     | 167.6 | x | 105.0     | x | 2.0 | 6.6   | x | 4.13  | x | 0.08  |
| VB0616-30073-0         | FM4274MP        | STEEL    | -----             | 61              | EXT TH     | 131.2 | x | 99.0      | x | 1.8 | 5.17  | x | 3.9   | x | 0.071 |
| VB0616-30074-0         | FM4271          | PAPER    | 2 PASS            | 45              | INT TH     | 125.5 | x | 93.3      | x | 2.1 | 4.94  | x | 3.67  | x | 0.084 |
| YN15V00009S005         | FM7089          | PAPER    | -----             | 57              | INT TH     | 166.0 | x | 137.5     | x | 3.0 | 6.54  | x | 5.41  | x | 0.118 |
| YN15V00009S007         | FM7092MP        | STEEL    | -----             | 6               | EXT LG     | 180.0 | x | 147.0     | x | 2.3 | 7.09  | x | 5.79  | x | 0.091 |
| YN15V00025S742         | FM7093          | PAPER    | 2 PASS            | 43              | INT TH     | 155.0 | x | 129.4     | x | 2.0 | 6.1   | x | 5.09  | x | 0.079 |
| YN15V00025S743         | FM7096MP        | STEEL    | -----             | 8               | EXT LG     | 163.7 | x | 139.0     | x | 1.7 | 6.44  | x | 5.47  | x | 0.067 |

| REPLACES<br>OEM PT.NO. | FMC<br>PART NO. | MATERIAL    | GROOVE<br>DETAILS | TEETH/<br>TANGS | SIZE MM    |       |   | SIZE INCH |   |     |       |   |       |   |       |
|------------------------|-----------------|-------------|-------------------|-----------------|------------|-------|---|-----------|---|-----|-------|---|-------|---|-------|
| YN15V00037S115         | FM7307          | PAPER       | -----             | 52              | INT TH     | 156.0 | x | 125.5     | x | 3.0 | 6.14  | x | 4.94  | x | 0.118 |
| YN15V00037S116         | FM7310MP        | STEEL       | -----             | 6               | EXT LG     | 167.6 | x | 133.1     | x | 2.3 | 6.6   | x | 5.24  | x | 0.091 |
| <b>KOMATSU</b>         |                 |             |                   |                 |            |       |   |           |   |     |       |   |       |   |       |
| 100-22-15101           | FM8477          | ORGANIC     | -----             | 76              | EXT TH     | 231.5 | x | 160.0     | x | 6.0 | 9.11  | x | 6.3   | x | 0.236 |
| 100-22-15102           | FM8477          | ORGANIC     | -----             | 76              | EXT TH     | 231.5 | x | 160.0     | x | 6.0 | 9.11  | x | 6.3   | x | 0.236 |
| 101-11-11100           | FM8479          | ORGANIC     | WAFFLE            | 16              | INT TH     | 260.0 | x | 26.8      | x | 6.0 | 10.24 | x | 1.06  | x | 0.236 |
| 101-11-11200           | FM8481          | ORGANIC     | WAFFLE            | 16              | INT TH     | 260.0 | x | 26.8      | x | 6.0 | 10.24 | x | 1.06  | x | 0.236 |
| 103-15-32711           | FM4381          | PAPER       | 2 PASS            | 37              | INT TH     | 180.0 | x | 138.5     | x | 3.0 | 7.09  | x | 5.45  | x | 0.118 |
| 103-22-31310           | FM4813          | ORGANIC     | -----             | 66              | EXT TH     | 202.0 | x | 147.0     | x | 6.0 | 7.95  | x | 5.79  | x | 0.236 |
| 104-22-33321           | FM4813          | ORGANIC     | -----             | 66              | EXT TH     | 202.0 | x | 147.0     | x | 6.0 | 7.95  | x | 5.79  | x | 0.236 |
| 10E-22-21320           | FM4506MP        | STEEL       | -----             | 46              | INT TH     | 190.0 | x | 132.0     | x | 2.0 | 7.48  | x | 5.2   | x | 0.079 |
| 110-22-11320           | FM8304MP        | STEEL       | -----             | 63              | INT TH     | 278.6 | x | 183.0     | x | 2.3 | 10.87 | x | 7.2   | x | 0.091 |
| 110-22-11332           | FM8301          | ORGANIC     | -----             | 95              | EXT TH     | 290.2 | x | 200.0     | x | 6.0 | 11.43 | x | 7.87  | x | 0.236 |
| 110-22-11333           | FM8301          | ORGANIC     | -----             | 95              | EXT TH     | 290.2 | x | 200.0     | x | 6.0 | 11.43 | x | 7.87  | x | 0.236 |
| 111-11-12120           | FM8306MP        | STEEL       | -----             | 111             | EXT TH     | 335.8 | x | 235.0     | x | 7.9 | 13.22 | x | 9.25  | x | 0.311 |
| 113-15-22710           | FM3161          | PAPER       | 2 PASS            | 56              | INT TH     | 215.0 | x | 169.0     | x | 3.0 | 8.46  | x | 6.65  | x | 0.118 |
| 113-15-22711           | FM3161          | PAPER       | 2 PASS            | 56              | INT TH     | 215.0 | x | 169.0     | x | 3.0 | 8.46  | x | 6.65  | x | 0.118 |
| 113-15-22720           | FM4722MP        | STEEL       | -----             | 5               | EXT LG     | 263.0 | x | 178.5     | x | 3.2 | 10.35 | x | 7.03  | x | 0.126 |
| 113-15-22730           | FM4618MP        | STEEL       | -----             | 5               | EXT LG     | 263.0 | x | 178.5     | x | 3.2 | 10.35 | x | 7.03  | x | 0.126 |
| 113-15-22740           | FM4381          | PAPER       | 2 PASS            | 37              | INT TH     | 180.0 | x | 138.5     | x | 3.0 | 7.09  | x | 5.45  | x | 0.118 |
| 113-15-22741           | FM4381          | PAPER       | 2 PASS            | 37              | INT TH     | 180.0 | x | 138.5     | x | 3.0 | 7.09  | x | 5.45  | x | 0.118 |
| 113-15-22750           | FM4464MP        | STEEL       | -----             | 5               | EXT LG     | 220.0 | x | 148.0     | x | 3.2 | 8.66  | x | 5.83  | x | 0.126 |
| 113-15-42711           | FM3161          | PAPER       | 2 PASS            | 56              | INT TH     | 215.0 | x | 169.0     | x | 3.0 | 8.46  | x | 6.65  | x | 0.118 |
| 120-22-31210           | FM8406MP        | STEEL       | -----             | 73              | INT TH     | 286.8 | x | 215.2     | x | 6.8 | 11.29 | x | 8.47  | x | 0.268 |
| 120-22-31211           | FM8406MP        | STEEL       | -----             | 73              | INT TH     | 286.8 | x | 215.2     | x | 6.8 | 11.29 | x | 8.47  | x | 0.268 |
| 120-22-31221           | FM3540MP        | STEEL       | -----             | 73              | INT TH     | 287.0 | x | 214.5     | x | 2.6 | 11.3  | x | 8.44  | x | 0.102 |
| 120-22-31231           | FM3521          | PAPER       | 2 PASS            | 99              | EXT TH     | 301.5 | x | 230.0     | x | 4.2 | 11.87 | x | 9.06  | x | 0.165 |
| 120-22-31232           | FM3521          | PAPER       | 2 PASS            | 99              | EXT TH     | 301.5 | x | 230.0     | x | 4.2 | 11.87 | x | 9.06  | x | 0.165 |
| 120-22-31233           | FM3521          | PAPER       | 2 PASS            | 99              | EXT TH     | 301.5 | x | 230.0     | x | 4.2 | 11.87 | x | 9.06  | x | 0.165 |
| 124-15-42710           | FM4737          | BRONZE      | SPR/WAG           | 75              | INT TH     | 280.0 | x | 221.0     | x | 5.0 | 11.02 | x | 8.7   | x | 0.196 |
| 124-15-42720           | FM5854MP        | STEEL       | -----             | 5               | EXT LG     | 338.5 | x | 234.5     | x | 5.0 | 13.33 | x | 9.23  | x | 0.197 |
| 124-15-52710           | FM6817          | CARBON      | WAFFLE            | 56              | INT TH     | 215.0 | x | 169.0     | x | 3.1 | 8.46  | x | 6.65  | x | 0.12  |
| 125-15-32710           | FM4767          | PAPER       | 2 PASS            | 100             | INT TH     | 250.0 | x | 197.0     | x | 3.0 | 9.84  | x | 7.76  | x | 0.118 |
| 125-15-32730           | FM3340MP        | STEEL       | -----             | 5               | EXT LG     | 300.0 | x | 210.0     | x | 3.2 | 11.81 | x | 8.27  | x | 0.126 |
| 125-15-32750           | FM5450MP        | STEEL       | -----             | 5               | EXT LG     | 252.0 | x | 179.0     | x | 3.2 | 9.92  | x | 7.05  | x | 0.126 |
| 125-21-23120           | FM7575          | BRONZE      | SPR/WAG           | 120             | EXT TH     | 365.0 | x | 290.0     | x | 4.1 | 14.37 | x | 11.42 | x | 0.161 |
| 125-21-23121           | FM7575          | BRONZE      | SPR/WAG           | 120             | EXT TH     | 365.0 | x | 290.0     | x | 4.1 | 14.37 | x | 11.42 | x | 0.161 |
| 12F-10-11240           | FM8359          | BRONZE      | SPR/WAG           | 64              | INT TH     | 321.0 | x | 188.0     | x | 7.0 | 12.64 | x | 7.4   | x | 0.275 |
| 12F-10-11241           | FM8359          | BRONZE      | SPR/WAG           | 64              | INT TH     | 321.0 | x | 188.0     | x | 7.0 | 12.64 | x | 7.4   | x | 0.275 |
| 130-22-11320           | FM7244MP        | STEEL       | -----             | 81              | INT TH     | 350.0 | x | 237.0     | x | 2.6 | 13.78 | x | 9.33  | x | 0.102 |
| 131-10-11110           | FM6731          | BZ/RIVETTED | SPR/WAG           | 87              | INT TH     | 375.0 | x | 257.0     | x | 7.0 | 14.76 | x | 10.94 | x | 0.275 |
| 131-10-11120           | FM4490MP        | STEEL       | -----             | 108             | (131)EX TH | 395.7 | x | 275.0     | x | 6.6 | 15.58 | x | 10.83 | x | 0.26  |
| 131-10-41610           | FM6731          | BZ/RIVETTED | SPR/WAG           | 87              | INT TH     | 375.0 | x | 257.0     | x | 7.0 | 14.76 | x | 10.94 | x | 0.275 |
| 131-10-61140           | FM2941          | BRONZE      | SPR/WAG           | 87              | INT TH     | 375.0 | x | 257.0     | x | 7.0 | 14.76 | x | 10.94 | x | 0.275 |
| 131-21-43210           | FM6681          | ORGANIC     | -----             | 120             | EXT TH     | 366.0 | x | 254.0     | x | 8.6 | 14.41 | x | 10.0  | x | 0.338 |
| 131-21-43213           | FM6681          | ORGANIC     | -----             | 120             | EXT TH     | 366.0 | x | 254.0     | x | 8.6 | 14.41 | x | 10.0  | x | 0.338 |



# Komatsu HD 785-5/7 Transmission Discs

---





| REPLACES<br>OEM PT.NO. | FMC<br>PART NO. | MATERIAL | GROOVE<br>DETAILS | TEETH/<br>TANGS | SIZE MM     |       |   | SIZE INCH |   |     |       |   |       |   |       |
|------------------------|-----------------|----------|-------------------|-----------------|-------------|-------|---|-----------|---|-----|-------|---|-------|---|-------|
| 131-21-43220           | FM2959          | BRONZE   | SPR/WAG           | 120             | EXT TH      | 366.0 | x | 260.0     | x | 4.1 | 14.41 | x | 10.24 | x | 0.161 |
| 131-21-43440           | FM7578MP        | STEEL    | -----             | 77              | INT TH      | 324.0 | x | 225.0     | x | 3.5 | 12.76 | x | 8.86  | x | 0.138 |
| 134-15-12720           | FM6558MP        | STEEL    | -----             | 5               | EXT LG      | 405.7 | x | 278.3     | x | 5.0 | 15.97 | x | 10.96 | x | 0.197 |
| 135-15-22712           | FM4009          | BRONZE   | SPR/WAG           | 90              | INT TH      | 335.0 | x | 264.0     | x | 5.0 | 13.19 | x | 10.39 | x | 0.197 |
| 135-15-22713           | FM4009          | BRONZE   | SPR/WAG           | 90              | INT TH      | 335.0 | x | 264.0     | x | 5.0 | 13.19 | x | 10.39 | x | 0.197 |
| 141-22-11240           | FM7600MP        | STEEL    | -----             | 88              | INT TH      | 372.0 | x | 258.0     | x | 2.6 | 14.65 | x | 10.16 | x | 0.1   |
| 144-10-12150           | FM2941          | BRONZE   | SPR/WAG           | 87              | INT TH      | 375.0 | x | 257.0     | x | 7.0 | 14.76 | x | 10.94 | x | 0.275 |
| 145-21-13120           | FM4143          | BRONZE   | SPR/WAG           | 111             | EXT TH      | 337.0 | x | 240.0     | x | 4.2 | 13.27 | x | 9.45  | x | 0.165 |
| 145-21-13121           | FM4143          | BRONZE   | SPR/WAG           | 111             | EXT TH      | 337.0 | x | 240.0     | x | 4.2 | 13.27 | x | 9.45  | x | 0.165 |
| 145-21-13130           | FM4146MP        | STEEL    | -----             | 63              | INT TH      | 323.7 | x | 225.2     | x | 2.3 | 12.74 | x | 8.87  | x | 0.091 |
| 145-21-13132           | FM4146MP        | STEEL    | -----             | 63              | INT TH      | 323.7 | x | 225.2     | x | 2.3 | 12.74 | x | 8.87  | x | 0.091 |
| 14X-15-22710           | FM6095          | CARBON   | WAFFLE            | 75              | INT TH      | 280.0 | x | 221.2     | x | 3.4 | 11.02 | x | 8.71  | x | 0.134 |
| 14X-15-22780           | FM6056MP        | STEEL    | -----             | 5               | EXT LG      | 337.2 | x | 234.2     | x | 3.2 | 13.28 | x | 9.22  | x | 0.128 |
| 14X-22-12150           | FM6359          | PAPER    | 2 PASS            | 84              | INT TH      | 330.0 | x | 247.5     | x | 4.7 | 12.99 | x | 9.74  | x | 0.185 |
| 14X-22-12160           | FM7110MP        | STEEL    | -----             | 115             | EXT TH      | 349.1 | x | 261.7     | x | 2.6 | 13.74 | x | 10.3  | x | 0.102 |
| 14X-22-22150           | FM6357          | PAPER    | 2 PASS            | 73              | INT TH      | 285.3 | x | 214.5     | x | 4.7 | 11.23 | x | 8.44  | x | 0.185 |
| 14X-960-3170           | FM6355          | PAPER    | 2 PASS            | 75              | INT TH      | 280.0 | x | 220.5     | x | 4.7 | 11.02 | x | 8.68  | x | 0.185 |
| 14X-960-3171           | FM6355          | PAPER    | 2 PASS            | 75              | INT TH      | 280.0 | x | 220.5     | x | 4.7 | 11.02 | x | 8.68  | x | 0.185 |
| 14Y-22-23150           | FM6342MP        | STEEL    | -----             | 109             | EXT TH      | 331.4 | x | 230.4     | x | 5.0 | 13.05 | x | 9.07  | x | 0.197 |
| 154-15-12713           | FM2739          | BRONZE   | SPR/WAG           | 97              | (105)INT TH | 400.8 | x | 309.6     | x | 5.3 | 15.78 | x | 12.19 | x | 0.21  |
| 154-15-12714           | FM2739          | BRONZE   | SPR/WAG           | 97              | (105)INT TH | 400.8 | x | 309.6     | x | 5.3 | 15.78 | x | 12.19 | x | 0.21  |
| 154-15-12715           | FM2739          | BRONZE   | SPR/WAG           | 97              | (105)INT TH | 400.8 | x | 309.6     | x | 5.3 | 15.78 | x | 12.19 | x | 0.21  |
| 154-15-12716           | FM2739          | BRONZE   | SPR/WAG           | 97              | (105)INT TH | 400.8 | x | 309.6     | x | 5.3 | 15.78 | x | 12.19 | x | 0.21  |
| 154-22-11230           | PC5814          | BRONZE   | SPR/WAG           | 128             | EXT TH      | 389.7 | x | 298.5     | x | 4.7 | 15.34 | x | 11.75 | x | 0.185 |
| 175-15-12713           | FM2741          | BRONZE   | SPR/WAG           | 114             | (126)INT TH | 475.0 | x | 372.6     | x | 5.4 | 18.7  | x | 14.67 | x | 0.213 |
| 175-15-12714           | FM2741          | BRONZE   | SPR/WAG           | 114             | (126)INT TH | 475.0 | x | 372.6     | x | 5.4 | 18.7  | x | 14.67 | x | 0.213 |
| 175-15-12715           | FM2741          | BRONZE   | SPR/WAG           | 114             | (126)INT TH | 475.0 | x | 372.6     | x | 5.4 | 18.7  | x | 14.67 | x | 0.213 |
| 175-15-12716           | FM2741          | BRONZE   | SPR/WAG           | 114             | (126)INT TH | 475.0 | x | 372.6     | x | 5.4 | 18.7  | x | 14.67 | x | 0.213 |
| 175-15-42721           | FM2748MP        | STEEL    | -----             | 6               | EXT TH      | 544.0 | x | 386.5     | x | 7.0 | 21.42 | x | 15.22 | x | 0.275 |
| 175-22-11140           | FM7597          | BRONZE   | SPR/WAG           | 128             | EXT TH      | 390.0 | x | 276.4     | x | 4.7 | 15.35 | x | 10.88 | x | 0.185 |
| 175-22-21150           | PC5814          | BRONZE   | SPR/WAG           | 128             | EXT TH      | 389.7 | x | 298.5     | x | 4.7 | 15.34 | x | 11.75 | x | 0.185 |
| 175-22-21160           | PP1036          | STEEL    | -----             | 95              | INT TH      | 372.1 | x | 279.0     | x | 2.9 | 14.65 | x | 10.98 | x | 0.144 |
| 17A-15-12710           | FM9091          | BRONZE   | SPR/WAG           | 85              | INT TH      | 314.8 | x | 251.3     | x | 5.0 | 12.39 | x | 9.89  | x | 0.197 |
| 17A-15-12722           | FM9094MP        | STEEL    | -----             | 6               | EXT LG      | 382.7 | x | 264.0     | x | 5.0 | 15.07 | x | 10.39 | x | 0.197 |
| 17A-15-22710           | FM9091          | BRONZE   | SPR/WAG           | 85              | INT TH      | 314.8 | x | 251.3     | x | 5.0 | 12.39 | x | 9.89  | x | 0.197 |
| 17A-15-42740           | FM8176MP        | STEEL    | -----             | 6               | EXT LG      | 466.5 | x | 323.0     | x | 3.2 | 18.37 | x | 12.72 | x | 0.126 |
| 17A-22-11170           | FM7043          | BRONZE   | SPR/WAG           | 106             | INT TH      | 403.0 | x | 314.0     | x | 4.5 | 15.87 | x | 12.36 | x | 0.177 |
| 17A-22-12120           | FM7046MP        | STEEL    | -----             | 140             | EXT TH      | 424.1 | x | 327.7     | x | 3.0 | 16.7  | x | 12.9  | x | 0.118 |
| 17M-22-13281           | FM7320MP        | STEEL    | -----             | 6               | EXT LG      | 466.7 | x | 323.6     | x | 3.0 | 18.37 | x | 12.74 | x | 0.118 |
| 17M-22-13291           | FM8173          | PAPER    | 2 PASS            | 106             | INT TH      | 400.0 | x | 313.5     | x | 4.5 | 15.75 | x | 11.95 | x | 0.177 |
| 17M-22-23290           | FM8173          | PAPER    | 2 PASS            | 106             | INT TH      | 400.0 | x | 313.5     | x | 4.5 | 15.75 | x | 11.95 | x | 0.177 |
| 17M-22-23310           | FM8173          | PAPER    | 2 PASS            | 106             | INT TH      | 400.0 | x | 313.5     | x | 4.5 | 15.75 | x | 11.95 | x | 0.177 |
| 17M-22-23320           | FM7043          | BRONZE   | SPR/WAG           | 106             | INT TH      | 403.0 | x | 314.0     | x | 4.5 | 15.87 | x | 12.36 | x | 0.177 |
| 195-15-12713           | FM2743          | BRONZE   | SPR/WAG           | 128             | (146)INT TH | 530.4 | x | 434.1     | x | 5.2 | 20.88 | x | 17.09 | x | 0.205 |
| 195-15-12714           | FM2743          | BRONZE   | SPR/WAG           | 128             | (146)INT TH | 530.4 | x | 434.1     | x | 5.2 | 20.88 | x | 17.09 | x | 0.205 |
| 195-15-12715           | FM2743          | BRONZE   | SPR/WAG           | 128             | (146)INT TH | 530.2 | x | 434.1     | x | 5.2 | 20.88 | x | 17.09 | x | 0.205 |
| 195-15-12716           | FM2743          | BRONZE   | SPR/WAG           | 128             | (146)INT TH | 530.2 | x | 434.1     | x | 5.2 | 20.88 | x | 17.09 | x | 0.205 |

| REPLACES OEM PT.NO. | FMC PART NO. | MATERIAL  | GROOVE DETAILS | TEETH/TANGS | SIZE MM    | SIZE INCH                                 |
|---------------------|--------------|-----------|----------------|-------------|------------|---|
| 195-15-12720        | FM2746MP     | STEEL     | -----          | 6           | EXT TH     | 610.1 x 446.5 x 5.8 24.02 x 17.58 x 0.23  |
| 195-15-12721        | FM2746MP     | STEEL     | -----          | 6           | EXT TH     | 610.1 x 446.5 x 5.8 24.02 x 17.58 x 0.23  |
| 195-15-32710        | FM2739       | BRONZE    | SPR/WAG        | 97          | (105)INTH  | 400.8 x 309.6 x 5.3 15.78 x 12.19 x 0.21  |
| 195-15-42711        | FM7203       | CARBON PA | SPR/RAD        | 126         | INT TH     | 425.0 x 373.0 x 5.4 16.73 x 14.69 x 0.213 |
| 195-15-42721        | FM7483       | BRONZE    | SPR/WAG        | 126         | INT TH     | 476.0 x 374.0 x 4.9 18.74 x 14.72 x 0.191 |
| 195-15-42780        | FM7482MP     | STEEL     | -----          | 6           | EXT LG     | 543.9 x 385.9 x 4.3 21.41 x 15.19 x 0.169 |
| 195-15-42790        | FM7486MP     | STEEL     | -----          | 6           | EXT LG     | 543.1 x 386.0 x 4.3 21.38 x 15.2 x 0.169  |
| 195-15-42850        | FM7432MP     | STEEL     | -----          | 117         | EXT TH     | 355.0 x 279.7 x 4.0 13.98 x 11.01 x 0.157 |
| 195-22-11211        | PC5813       | BRONZE    | SPR/WAG        | 150         | EXT TH     | 454.1 x 347.9 x 4.7 17.88 x 13.7 x 0.185  |
| 195-22-11221        | FM1038MP     | STEEL     | -----          | 114         | INT TH     | 436.4 x 338.4 x 2.9 17.18 x 13.32 x 0.114 |
| 195-22-13341        | FM7367       | BRONZE    | SPR/WAG        | 112         | INT TH     | 425.0 x 334.7 x 4.7 16.73 x 13.18 x 0.185 |
| 195-22-13350        | FM5973       | PAPER     | 2 PASS         | 112         | INT TH     | 425.0 x 334.5 x 4.7 16.73 x 13.17 x 0.185 |
| 195-22-13351        | FM5973       | PAPER     | 2 PASS         | 112         | INT TH     | 425.0 x 334.5 x 4.7 16.73 x 13.17 x 0.185 |
| 195-22-13370        | FM7370MP     | STEEL     | -----          | 6           | EXT LG     | 495.7 x 348.5 x 3.0 19.52 x 13.72 x 0.118 |
| 195-22-13441        | FM5973       | PAPER     | 2 PASS         | 112         | INT TH     | 425.0 x 334.5 x 4.7 16.73 x 13.17 x 0.185 |
| 195-22-73340        | FM7367       | BRONZE    | SPR/WAG        | 112         | INT TH     | 425.0 x 334.7 x 4.7 16.73 x 13.18 x 0.185 |
| 198-15-22810        | FM4103       | BRONZE    | SPR/WAG        | 112         | INT TH     | 425.0 x 330.0 x 5.4 16.73 x 12.99 x 0.213 |
| 198-22-23370        | FM7969       | PAPER     | 2 PASS         | 146         | INT TH     | 529.7 x 434.2 x 5.0 20.85 x 17.09 x 0.197 |
| 198-22-23371        | FM7969       | PAPER     | 2 PASS         | 146         | INT TH     | 529.7 x 434.2 x 5.0 20.85 x 17.09 x 0.197 |
| 198-22-23380        | FM7972MP     | STEEL     | -----          | 6           | EXT LG     | 606.4 x 446.5 x 4.2 23.87 x 17.58 x 0.165 |
| 19M-15-12721        | FM2741       | BRONZE    | SPR/WAG        | 114         | (126)INTTH | 475.0 x 372.6 x 5.4 18.7 x 14.66 x 0.213  |
| 20E-22-K1304        | FM4015       | GRAPHITE  | SUNBURST       | 27          | INT TH     | 303.8 x 66.1 x 10.0 11.96 x 2.6 x 0.393   |
| 20G-14-31450        | FM8263       | BRONZE    | WAF/RAD        | 54          | EXT TH     | 109.4 x 82.1 x 1.6 4.31 x 3.23 x 0.063    |
| 20G-14-31540        | FM8817       | BRONZE    | WAF/RAD        | 50          | (75)EX TH  | 190.0 x 132.2 x 1.8 7.48 x 5.2 x 0.071    |
| 20G-14-31890        | FM8263       | BRONZE    | WAF/RAD        | 54          | EXT TH     | 109.4 x 82.1 x 1.6 4.31 x 3.23 x 0.063    |
| 20G-22-31910        | FM8820MP     | STEEL     | HARDENED       | 31          | INT TH     | 168.6 x 122.3 x 2.0 6.64 x 4.81 x 0.079   |
| 20K-14-32130        | FM8263       | BRONZE    | WAF/RAD        | 54          | EXT TH     | 109.4 x 82.1 x 1.6 4.31 x 3.23 x 0.063    |
| 20K-14-32140        | FM8816MP     | STEEL     | HARDENED       | 52          | INT TH     | 102.0 x 77.2 x 1.5 4.02 x 3.04 x 0.059    |
| 20K-14-32150        | FM8817       | BRONZE    | WAF/RAD        | 50          | (75)EX TH  | 190.0 x 132.2 x 1.8 7.48 x 5.2 x 0.071    |
| 20K-14-32160        | FM8820MP     | STEEL     | HARDENED       | 31          | INT TH     | 168.6 x 122.3 x 2.0 6.64 x 4.81 x 0.079   |
| 20K-14-32620        | FM8817       | BRONZE    | WAF/RAD        | 50          | (75)EX TH  | 190.0 x 132.2 x 1.8 7.48 x 5.2 x 0.071    |
| 20K-23-31890        | FM9053       | BRONZE    | SUN/WAF        | 42          | (48)EX TH  | 248.5 x 164.7 x 2.6 9.78 x 6.48 x 0.102   |
| 20K-23-31910        | FM9056MP     | STEEL     | HARDENED       | 33          | (39)INT TH | 234.8 x 154.0 x 2.7 9.24 x 6.6 x 0.106    |
| 20K-23-32210        | FM9056MP     | STEEL     | HARDENED       | 33          | (39)INT TH | 234.8 x 154.0 x 2.7 9.24 x 6.6 x 0.106    |
| 21P-26-K0320        | FM7635       | BRONZE    | WAFFLE         | 37          | EXT TH     | 113.8 x 85.0 x 2.2 4.48 x 3.35 x 0.087    |
| 21P-26-K0330        | FM7638MP     | STEEL     | -----          | 27          | INT TH     | 107.2 x 78.7 x 1.5 4.22 x 3.1 x 0.059     |
| 232-25-51410        | FM2859       | PAPER     | 2 PASS         | 105         | INT TH     | 399.3 x 309.4 x 3.8 15.72 x 12.18 x 0.15  |
| 232-25-51430        | FM2862MP     | STEEL     | -----          | 138         | EXT TH     | 419.6 x 324.4 x 2.4 16.52 x 12.77 x 0.095 |
| 232-25-51520        | FM2862MP     | STEEL     | -----          | 138         | EXT TH     | 419.6 x 324.4 x 2.4 16.52 x 12.77 x 0.095 |
| 234-25-31350        | FM2859       | PAPER     | 2 PASS         | 105         | INT TH     | 399.3 x 309.4 x 3.8 15.72 x 12.18 x 0.15  |
| 235-25-11360        | FM2859       | PAPER     | 2 PASS         | 105         | INT TH     | 399.3 x 309.4 x 3.8 15.72 x 12.18 x 0.15  |
| 235-25-51430        | FM2862MP     | STEEL     | -----          | 138         | EXT TH     | 419.6 x 324.4 x 2.4 16.52 x 12.77 x 0.095 |
| 238-15-12710        | FM3341       | BRONZE    | SPR/WAG        | 100         | INT TH     | 250.0 x 197.0 x 3.0 9.84 x 7.76 x 0.118   |
| 238-15-12760        | FM6152MP     | STEEL     | -----          | 5           | EXT LG     | 300.8 x 210.0 x 3.2 11.84 x 8.27 x 0.126  |
| 238-15-12780        | FM7528MP     | STEEL     | -----          | 132         | EXT TH     | 266.6 x 208.0 x 3.2 10.5 x 8.19 x 0.126   |
| 238-15-12810        | FM3340MP     | STEEL     | -----          | 5           | EXT LG     | 300.0 x 210.0 x 3.2 11.81 x 8.27 x 0.126  |
| 23A-22-11780        | FM4677       | PAPER     | 2 PASS         | 26          | INT TH     | 210.0 x 102.0 x 3.8 8.27 x 4.02 x 0.15    |
| 23C-25-51331        | FM2859       | PAPER     | 2 PASS         | 105         | INT TH     | 399.3 x 309.4 x 3.8 15.72 x 12.18 x 0.15  |

| REPLACES<br>OEM PT.NO. | FMC<br>PART NO. | MATERIAL  | GROOVE<br>DETAILS | TEETH/<br>TANGS | SIZE MM |       |   | SIZE INCH |   |     |       |   |       |   |       |
|------------------------|-----------------|-----------|-------------------|-----------------|---------|-------|---|-----------|---|-----|-------|---|-------|---|-------|
| 23S-15-12710           | FM4737          | BRONZE    | SPR/WAG           | 75              | INT TH  | 280.0 | x | 221.0     | x | 5.0 | 11.02 | x | 8.7   | x | 0.196 |
| 23S-15-12720           | FM3341          | BRONZE    | SPR/WAG           | 100             | INT TH  | 250.0 | x | 197.0     | x | 3.0 | 9.84  | x | 7.76  | x | 0.118 |
| 23S-15-12730           | FM3839          | GRAPHITE  | SPR/RAD           | 75              | INT TH  | 280.0 | x | 221.0     | x | 5.0 | 11.02 | x | 8.7   | x | 0.197 |
| 23S-15-12740           | FM3063          | GRAPHITE  | SPR/RAD           | 100             | INT TH  | 250.0 | x | 197.0     | x | 3.0 | 9.84  | x | 7.76  | x | 0.118 |
| 23S-15-12810           | FM3340MP        | STEEL     | -----             | 5               | EXT LG  | 300.0 | x | 210.0     | x | 3.2 | 11.81 | x | 8.27  | x | 0.126 |
| 23S-15-42720           | FM4767          | PAPER     | 2 PASS            | 100             | INT TH  | 250.0 | x | 197.0     | x | 3.0 | 9.84  | x | 7.76  | x | 0.118 |
| 23S-15-42730           | FM3161          | PAPER     | 2 PASS            | 56              | INT TH  | 215.0 | x | 169.0     | x | 3.0 | 8.46  | x | 6.65  | x | 0.118 |
| 281-15-12720           | FM2834MP        | STEEL     | -----             | 138             | EXT TH  | 419.9 | x | 324.9     | x | 5.0 | 16.53 | x | 12.79 | x | 0.196 |
| 281-15-12721           | FM2834MP        | STEEL     | -----             | 138             | EXT TH  | 419.9 | x | 324.9     | x | 5.0 | 16.53 | x | 12.79 | x | 0.196 |
| 287-15-12990           | FM8456MP        | STEEL     | -----             | 117             | EXT TH  | 354.8 | x | 280.0     | x | 5.0 | 13.97 | x | 11.02 | x | 0.197 |
| 287-15-22710           | FM9089          | STEEL     | -----             | 105             | INT TH  | 382.7 | x | 311.2     | x | 5.0 | 15.07 | x | 12.25 | x | 0.197 |
| 308-15-21525           | FM3460MP        | STEEL     | -----             | 12              | EXT SL  | 174.5 | x | 85.6      | x | 1.8 | 6.87  | x | 3.37  | x | 0.071 |
| 310-15-24310           | FM2330MP        | STEEL     | -----             | 12              | EXT SL  | 174.5 | x | 85.6      | x | 1.8 | 6.87  | x | 3.37  | x | 0.071 |
| 310-15-24330           | FM2273          | BRONZE    | SPR/WAG           | 32              | INT TH  | 146.0 | x | 78.6      | x | 1.6 | 5.75  | x | 3.09  | x | 0.063 |
| 312-15-11280           | FM3366MP        | STEEL     | -----             | 8               | EXT LG  | 190.0 | x | 128.5     | x | 1.9 | 7.48  | x | 5.06  | x | 0.075 |
| 324-15-12650           | FM2070MP        | STEEL     | -----             | 8               | EXT LG  | 131.6 | x | 77.2      | x | 1.0 | 5.18  | x | 3.04  | x | 0.039 |
| 324-15-12660           | FM2061          | PAPER     | WAFFLE            | 41              | INT TH  | 125.0 | x | 68.6      | x | 2.6 | 4.92  | x | 2.7   | x | 0.102 |
| 324-15-12660           | FM1805          | BRONZE    | SUNBURST          | 41              | INT TH  | 125.0 | x | 68.6      | x | 2.6 | 4.92  | x | 2.7   | x | 0.102 |
| 34B-15-11340           | FM2449          | BRONZE    | SUNBURST          | 41              | INT TH  | 125.0 | x | 68.6      | x | 3.0 | 4.92  | x | 2.7   | x | 0.118 |
| 34C-15-11350           | FM2759          | BRONZE    | SUNBURST          | 47              | INT TH  | 152.5 | x | 90.5      | x | 3.0 | 6.0   | x | 3.56  | x | 0.118 |
| 34C-15-11360           | FM3204MP        | STEEL     | -----             | 8               | EXT LG  | 162.0 | x | 100.0     | x | 1.6 | 6.38  | x | 3.94  | x | 0.063 |
| 362-15-12720           | FM4384MP        | STEEL     | -----             | 5               | EXT LG  | 228.0 | x | 148.0     | x | 3.2 | 8.98  | x | 5.83  | x | 0.126 |
| 362-15-12730           | FM4386MP        | STEEL     | -----             | 5               | EXT LG  | 228.0 | x | 148.0     | x | 3.2 | 8.98  | x | 5.83  | x | 0.126 |
| 363-15-22750           | FM4624MP        | STEEL     | -----             | 51              | EXT TH  | 131.5 | x | 80.0      | x | 1.8 | 5.18  | x | 3.15  | x | 0.071 |
| 380-125504H1           | FM2273          | BRONZE    | SPR/WAG           | 32              | INT TH  | 146.0 | x | 78.6      | x | 1.6 | 5.75  | x | 3.09  | x | 0.063 |
| 380-125505H1           | FM2276MP        | STEEL     | -----             | 12              | EXT SL  | 174.6 | x | 85.7      | x | 1.8 | 6.87  | x | 3.37  | x | 0.071 |
| 380-129529-1           | FM2330MP        | STEEL     | -----             | 12              | EXT SL  | 174.5 | x | 85.6      | x | 1.8 | 6.87  | x | 3.37  | x | 0.071 |
| 380-176345-2           | FM2379          | BRONZE    | SUNBURST          | 29              | INT TH  | 168.1 | x | 119.1     | x | 2.5 | 6.62  | x | 4.69  | x | 0.1   |
| 380-215737-1           | FM2332MP        | STEEL     | -----             | 12              | EXT SL  | 174.5 | x | 112.8     | x | 1.8 | 6.87  | x | 4.44  | x | 0.071 |
| 380-219179-1           | FM2295          | BRONZE    | SPR/WAG           | 34              | INT TH  | 146.1 | x | 104.9     | x | 1.7 | 5.75  | x | 4.13  | x | 0.066 |
| 380-220025H1           | FM1690MP        | STEEL     | -----             | 12              | EXT SL  | 174.6 | x | 112.8     | x | 1.8 | 6.87  | x | 4.44  | x | 0.071 |
| 381-114622-1           | FM1765          | RED PAPER | 2 PASS            | 15              | INT TH  | 259.1 | x | 51.1      | x | 7.6 | 10.2  | x | 2.01  | x | 0.3   |
| 381-114622-1           | FM3807          | YELLOW PA | 2 PASS            | 15              | INT TH  | 259.1 | x | 51.1      | x | 7.6 | 10.2  | x | 2.01  | x | 0.3   |
| 381-619200-1           | FM4525OE        | BRONZE    | SUNBURST          | 39              | INT TH  | 228.9 | x | 162.0     | x | 2.9 | 9.01  | x | 6.38  | x | 0.112 |
| 381-893515-1           | FM1690MP        | STEEL     | -----             | 12              | EXT SL  | 174.6 | x | 112.8     | x | 1.8 | 6.87  | x | 4.44  | x | 0.071 |
| 381-922539-1           | FM1560MP        | STEEL     | -----             | 85              | EXT TH  | 181.6 | x | 85.6      | x | 1.7 | 7.15  | x | 3.37  | x | 0.066 |
| 381-922540-1           | FM4420MP        | STEEL     | END PLATE         | 85              | EXT TH  | 181.4 | x | 85.6      | x | 4.8 | 7.14  | x | 3.37  | x | 0.189 |
| 381-922541-1           | FM1565          | PAPER     | 2 PASS            | 32              | INT TH  | 167.6 | x | 78.7      | x | 1.8 | 6.6   | x | 3.1   | x | 0.07  |
| 381-922549-1           | FM1562MP        | STEEL     | -----             | 85              | EXT TH  | 181.4 | x | 112.8     | x | 1.7 | 7.14  | x | 4.44  | x | 0.066 |
| 381-922551-1           | FM1567          | PAPER     | 2 PASS            | 34              | INT TH  | 167.6 | x | 104.6     | x | 1.8 | 6.6   | x | 4.12  | x | 0.07  |
| 381-922913-1           | FM2068MP        | STEEL     | -----             |                 | SPRING  | 179.8 | x | 173.5     | x | 0.4 | 7.08  | x | 6.83  | x | 0.016 |
| 381-924109-1           | FM4528MP        | STEEL     | RUBBER PINS       | 8               | EXT LG  | 244.0 | x | 173.0     | x | 3.2 | 9.61  | x | 6.81  | x | 0.126 |
| 381-970697-2           | FM1690MP        | STEEL     | -----             | 12              | EXT SL  | 174.5 | x | 112.8     | x | 1.8 | 6.87  | x | 4.44  | x | 0.071 |
| 381-984439-1           | FM1836MP        | STEEL     | -----             | 3               | INT LG  | 259.0 | x | 185.7     | x | 6.7 | 10.19 | x | 7.31  | x | 0.262 |
| 382-327174-1           | FM2382MP        | STEEL     | -----             | 8               | EXT LG  | 180.1 | x | 129.5     | x | 2.1 | 7.09  | x | 5.1   | x | 0.083 |
| 382-399734-1           | FM1765          | RED PAPER | 2 PASS            | 15              | INT TH  | 259.0 | x | 51.0      | x | 7.6 | 10.2  | x | 2.01  | x | 0.3   |
| 382-399734-1           | FM3807          | YELLOW PA | 2 PASS            | 15              | INT TH  | 259.1 | x | 51.1      | x | 7.6 | 10.2  | x | 2.01  | x | 0.3   |

| REPLACES<br>OEM PT.NO. | FMC<br>PART NO. | MATERIAL  | GROOVE<br>DETAILS | TEETH/<br>TANGS | SIZE MM |       |   | SIZE INCH |   |     |       |   |      |   |       |
|------------------------|-----------------|-----------|-------------------|-----------------|---------|-------|---|-----------|---|-----|-------|---|------|---|-------|
| 385-10235131           | FM4462MP        | STEEL     | END PLATE         | 85              | EXT TH  | 181.4 | x | 85.6      | x | 5.5 | 7.14  | x | 3.37 | x | 0.217 |
| 385-10272561-4         | FM1765          | RED PAPER | 2 PASS            | 15              | INT TH  | 259.1 | x | 51.1      | x | 7.6 | 10.2  | x | 2.01 | x | 0.3   |
| 385-10272561-4         | FM3807          | YELLOW PA | 2 PASS            | 15              | INT TH  | 259.1 | x | 51.1      | x | 7.6 | 10.2  | x | 2.01 | x | 0.3   |
| 385-11121301           | FM6169          | PAPER     | 2 PASS            | 34              | INT TH  | 228.5 | x | 140.7     | x | 3.0 | 9.0   | x | 5.53 | x | 0.118 |
| 385-11132371           | FM5317          | PAPER     | WAFFLE            | 34              | INT TH  | 201.1 | x | 104.9     | x | 2.6 | 7.92  | x | 4.13 | x | 0.102 |
| 385-11132451           | FM5320MP        | STEEL     | -----             | 85              | EXT TH  | 217.4 | x | 112.8     | x | 1.9 | 8.56  | x | 4.44 | x | 0.075 |
| 3EA-15-11170           | FM2063          | PAPER     | WAFFLE            | 41              | INT TH  | 125.0 | x | 68.6      | x | 2.9 | 4.92  | x | 2.7  | x | 0.114 |
| 3EA-15-11171           | FM2063          | PAPER     | WAFFLE            | 41              | INT TH  | 125.0 | x | 68.6      | x | 2.9 | 4.92  | x | 2.7  | x | 0.114 |
| 3EA-15-11172           | FM2063          | PAPER     | WAFFLE            | 41              | INT TH  | 125.0 | x | 68.6      | x | 2.9 | 4.92  | x | 2.7  | x | 0.114 |
| 3EA-15-11173           | FM2063          | PAPER     | WAFFLE            | 41              | INT TH  | 125.0 | x | 68.6      | x | 2.9 | 4.92  | x | 2.7  | x | 0.114 |
| 3EA-15-11180           | FM2440MP        | STEEL     | -----             | 4               | EXT LG  | 137.8 | x | 80.0      | x | 3.2 | 5.42  | x | 3.15 | x | 0.125 |
| 3EA-15-11340           | FM2063          | PAPER     | WAFFLE            | 41              | INT TH  | 125.0 | x | 68.6      | x | 2.9 | 4.92  | x | 2.7  | x | 0.114 |
| 3EA-15-12721           | FM2063          | PAPER     | WAFFLE            | 41              | INT TH  | 125.0 | x | 68.6      | x | 2.9 | 4.92  | x | 2.7  | x | 0.114 |
| 3EA-15-14270           | FM2449          | BRONZE    | SUNBURST          | 41              | INT TH  | 125.0 | x | 68.5      | x | 3.0 | 4.92  | x | 2.7  | x | 0.118 |
| 3EA-15-31170           | FM2063          | PAPER     | WAFFLE            | 41              | INT TH  | 125.0 | x | 68.6      | x | 2.9 | 4.92  | x | 2.7  | x | 0.114 |
| 3EB-15-51170           | FM6797          | PAPER     | WAFFLE            | 41              | INT TH  | 125.0 | x | 68.6      | x | 3.1 | 4.92  | x | 2.7  | x | 0.122 |
| 3EC-15-19270           | FM2721          | BRONZE    | SUNBURST          | 47              | INT TH  | 147.0 | x | 90.5      | x | 3.0 | 5.79  | x | 3.56 | x | 0.118 |
| 3EC-15-19280           | FM2724MP        | STEEL     | -----             | 8               | EXT LG  | 157.0 | x | 100.0     | x | 1.4 | 6.18  | x | 3.94 | x | 0.055 |
| 3EC-15-29270           | FM2721          | BRONZE    | SUNBURST          | 47              | INT TH  | 147.0 | x | 90.5      | x | 3.0 | 5.79  | x | 3.56 | x | 0.118 |
| 3EC-15-29270           | FM3713          | BRONZE    | SUN/RAD           | 47              | INT TH  | 147.0 | x | 90.5      | x | 3.0 | 5.79  | x | 3.56 | x | 0.118 |
| 3EC-15-29280           | FM2724MP        | STEEL     | -----             | 8               | EXT LG  | 157.0 | x | 100.0     | x | 1.4 | 6.18  | x | 3.94 | x | 0.055 |
| 3EC-15-31270           | FM3515          | PAPER     | WAFFLE            | 37              | INT TH  | 155.7 | x | 87.9      | x | 2.6 | 6.13  | x | 3.46 | x | 0.102 |
| 3EC-15-31280           | FM3518MP        | STEEL     | -----             | 8               | EXT LG  | 168.0 | x | 100.0     | x | 2.0 | 6.61  | x | 3.94 | x | 0.078 |
| 3EC-15-31290           | FM4484MP        | STEEL     | END PLATE         | 8               | EXT LG  | 167.0 | x | 100.0     | x | 4.6 | 6.57  | x | 3.94 | x | 0.179 |
| 3EC-30-51110           | FM7663          | PAPER     | WAFFLE            | 18              | INT TH  | 208.0 | x | 51.4      | x | 4.4 | 8.19  | x | 2.02 | x | 0.173 |
| 3EC-30-51220           | FM7666MP        | STEEL     | -----             | 4               | EXT LG  | 254.6 | x | 148.0     | x | 3.7 | 10.02 | x | 5.83 | x | 0.146 |
| 3EE-15-11510           | FM2937          | BRONZE    | SUNBURST          | 60              | INT TH  | 174.0 | x | 116.1     | x | 3.0 | 6.85  | x | 4.57 | x | 0.118 |
| 3EE-15-12950           | FM2937          | BRONZE    | SUNBURST          | 60              | INT TH  | 174.0 | x | 116.1     | x | 3.0 | 6.85  | x | 4.57 | x | 0.118 |
| 3EE-15-12960           | FM3366MP        | STEEL     | -----             | 8               | EXT LG  | 190.0 | x | 128.5     | x | 1.9 | 7.48  | x | 5.06 | x | 0.075 |
| 3EE-15-21230           | FM2936MP        | STEEL     | -----             | 4               | EXT LG  | 162.0 | x | 100.3     | x | 2.0 | 6.38  | x | 3.95 | x | 0.079 |
| 3FD-15-21570           | FM3515          | PAPER     | WAFFLE            | 37              | INT TH  | 155.7 | x | 87.9      | x | 2.6 | 6.13  | x | 3.46 | x | 0.102 |
| 415-33-11240           | FM3065          | PAPER     | 2 PASS            | 16              | INT TH  | 208.0 | x | 44.0      | x | 5.3 | 8.19  | x | 1.34 | x | 0.209 |
| 415-33-11241           | FM7613          | PAPER     | 2 PASS            | 16              | INT TH  | 208.0 | x | 44.0      | x | 6.7 | 8.19  | x | 1.34 | x | 0.264 |
| 415-33-11250           | FM4692MP        | STEEL     | -----             | 3               | INT LG  | 207.5 | x | 150.0     | x | 3.8 | 8.17  | x | 5.91 | x | 0.15  |
| 415-33-21240           | FM7613          | PAPER     | 2 PASS            | 16              | INT TH  | 208.0 | x | 44.0      | x | 6.7 | 8.19  | x | 1.34 | x | 0.264 |
| 417-33-11243           | FM3463          | PAPER     | 2 PASS            | 15              | INT TH  | 264.0 | x | 50.0      | x | 8.6 | 10.39 | x | 1.97 | x | 0.339 |
| 417-33-11252           | FM3244MP        | STEEL     | -----             | 3               | INT LG  | 264.0 | x | 172.4     | x | 6.5 | 10.39 | x | 6.79 | x | 0.255 |
| 417-33-11253           | FM3244MP        | STEEL     | -----             | 3               | INT LG  | 264.0 | x | 172.4     | x | 6.5 | 10.39 | x | 6.79 | x | 0.255 |
| 417-33-11290           | FM3463          | PAPER     | 2 PASS            | 15              | INT TH  | 264.0 | x | 50.0      | x | 8.6 | 10.39 | x | 1.97 | x | 0.339 |
| 418-17-39710           | FM4831          | PAPER     | 2 PASS            | 26              | INT TH  | 160.0 | x | 97.5      | x | 2.2 | 6.3   | x | 3.84 | x | 0.087 |
| 418-33-11240           | FM3015          | PAPER     | 2 PASS            | 15              | INT TH  | 276.0 | x | 50.3      | x | 8.7 | 10.87 | x | 1.98 | x | 0.343 |
| 418-33-11241           | FM3015          | PAPER     | 2 PASS            | 15              | INT TH  | 276.0 | x | 50.3      | x | 8.7 | 10.87 | x | 1.98 | x | 0.343 |
| 418-33-11250           | FM5366MP        | STEEL     | -----             | 3               | INT LG  | 277.0 | x | 174.0     | x | 6.6 | 10.91 | x | 6.85 | x | 0.26  |
| 418-33-11251           | FM3246MP        | STEEL     | -----             | 3               | INT LG  | 276.8 | x | 173.8     | x | 9.3 | 10.9  | x | 6.84 | x | 0.364 |
| 418-33-21340           | FM3527          | PAPER     | 2 PASS            | 15              | INT TH  | 303.0 | x | 58.0      | x | 8.7 | 11.93 | x | 2.28 | x | 0.344 |
| 419-15-12132           | FM2916MP        | STEEL     | -----             |                 | SPRING  | 174.7 | x | 166.2     | x | 0.7 | 6.88  | x | 6.54 | x | 0.028 |
| 419-15-12133           | FM2916MP        | STEEL     | -----             |                 | SPRING  | 174.7 | x | 166.2     | x | 0.7 | 6.88  | x | 6.54 | x | 0.028 |
| 419-15-12290           | FM3177          | PAPER     | WAFFLE            | 26              | INT TH  | 160.0 | x | 97.5      | x | 2.2 | 6.3   | x | 3.84 | x | 0.087 |

| REPLACES<br>OEM PT.NO. | FMC<br>PART NO. | MATERIAL  | GROOVE<br>DETAILS | TEETH/<br>TANGS | SIZE MM   |       |   | SIZE INCH |   |     |       |   |       |   |       |
|------------------------|-----------------|-----------|-------------------|-----------------|-----------|-------|---|-----------|---|-----|-------|---|-------|---|-------|
| 419-15-12290C          | FM4837          | RED PAPER | WAFFLE            | 26              | INT TH    | 160.0 | x | 97.5      | x | 2.2 | 6.3   | x | 3.84  | x | 0.087 |
| 419-15-12290L          | FM4837          | RED PAPER | WAFFLE            | 26              | INT TH    | 160.0 | x | 97.5      | x | 2.2 | 6.3   | x | 3.84  | x | 0.087 |
| 419-15-12310           | FM2914MP        | STEEL     | -----             | 68              | EXT TH    | 174.1 | x | 110.0     | x | 1.7 | 6.85  | x | 4.33  | x | 0.066 |
| 419-15-12920           | FM2914MP        | STEEL     | -----             | 68              | EXT TH    | 174.1 | x | 110.0     | x | 1.7 | 6.85  | x | 4.33  | x | 0.066 |
| 419-15-31750           | FM7452MP        | STEEL     | -----             | 5               | EXT LG    | 349.9 | x | 218.0     | x | 6.6 | 13.78 | x | 8.58  | x | 0.258 |
| 419-33-11243           | FM2907          | PAPER     | 2 PASS            | 15              | INT TH    | 320.0 | x | 67.5      | x | 8.2 | 12.6  | x | 2.66  | x | 0.322 |
| 419-33-11250           | FM2910MP        | STEEL     | -----             | 3               | INT LG    | 322.0 | x | 215       | x | 6.6 | 12.68 | x | 8.46  | x | 0.259 |
| 419-33-11252           | FM3248MP        | STEEL     | -----             | 3               | INT LG    | 322.0 | x | 215.0     | x | 9.2 | 12.68 | x | 8.46  | x | 0.362 |
| 419-33-21240           | FM2907          | PAPER     | 2 PASS            | 15              | INT TH    | 320.0 | x | 67.5      | x | 8.2 | 12.6  | x | 2.66  | x | 0.322 |
| 419-33-21250           | FM6792MP        | STEEL     | -----             | 68              | EXT TH    | 347.8 | x | 237.6     | x | 6.0 | 13.69 | x | 9.35  | x | 0.236 |
| 419-33-21750           | FM6086MP        | STEEL     | -----             | 5               | EXT LG    | 350.0 | x | 218.0     | x | 6.5 | 13.78 | x | 8.58  | x | 0.256 |
| 419-33-21751           | FM6086MP        | STEEL     | -----             | 5               | EXT LG    | 350.0 | x | 218.0     | x | 6.5 | 13.78 | x | 8.58  | x | 0.256 |
| 421-22-27410           | FM6235          | Mo        | SPR/RAD           | 32              | (38)IN TH | 198.0 | x | 103.0     | x | 3.6 | 7.8   | x | 4.06  | x | 0.142 |
| 421-22-27411           | FM6235          | Mo        | SPR/RAD           | 32              | (38)IN TH | 198.0 | x | 103.0     | x | 3.6 | 7.8   | x | 4.06  | x | 0.142 |
| 421-22-27450           | FM6238-3.4      | STEEL     | HARDENED          | 6               | EXT LG    | 229.9 | x | 114.2     | x | 3.4 | 9.05  | x | 4.5   | x | 0.134 |
| 421-22-27451           | FM6238-3.4      | STEEL     | HARDENED          | 6               | EXT LG    | 229.9 | x | 114.2     | x | 3.4 | 9.05  | x | 4.5   | x | 0.134 |
| 421-22-27460           | FM6238-3.5      | STEEL     | HARDENED          | 6               | EXT LG    | 229.9 | x | 114.2     | x | 3.5 | 9.05  | x | 4.5   | x | 0.138 |
| 421-22-27461           | FM6238-3.5      | STEEL     | HARDENED          | 6               | EXT LG    | 229.9 | x | 114.2     | x | 3.5 | 9.05  | x | 4.5   | x | 0.138 |
| 421-33-31241           | FM7531          | PAPER     | 2 PASS            | 15              | INT TH    | 374.0 | x | 72.8      | x | 6.5 | 14.72 | x | 2.87  | x | 0.256 |
| 421-33-31242           | FM7531          | PAPER     | 2 PASS            | 15              | INT TH    | 374.0 | x | 72.8      | x | 6.5 | 14.72 | x | 2.87  | x | 0.256 |
| 421-33-31250           | FM7454MP        | STEEL     | -----             | 3               | EXT LG    | 417.8 | x | 297.0     | x | 6.0 | 16.45 | x | 11.69 | x | 0.236 |
| 421-33-31340           | FM7536MP        | STEEL     | -----             | 4               | EXT LG    | 428.8 | x | 297.0     | x | 3.3 | 16.88 | x | 11.69 | x | 0.128 |
| 421-33-31350           | FM7534MP        | STEEL     | -----             | 3               | EXT LG    | 428.8 | x | 297.0     | x | 6.0 | 16.88 | x | 11.69 | x | 0.236 |
| 421-33-32240           | FM7537          | PAPER     | 2 PASS            | 15              | INT TH    | 352.0 | x | 69.0      | x | 6.5 | 13.86 | x | 2.72  | x | 0.256 |
| 421-33-32241           | FM7537          | PAPER     | 2 PASS            | 15              | INT TH    | 352.0 | x | 69.0      | x | 6.5 | 13.86 | x | 2.72  | x | 0.256 |
| 421-33-32250           | FM7456MP        | STEEL     | -----             | 3               | EXT LG    | 395.6 | x | 280.3     | x | 6.0 | 15.57 | x | 11.04 | x | 0.236 |
| 421-33-32251           | FM7456MP        | STEEL     | -----             | 3               | EXT LG    | 395.6 | x | 280.3     | x | 6.0 | 15.57 | x | 11.04 | x | 0.236 |
| 421-33-32340           | FM7542MP        | STEEL     | -----             | 4               | EXT LG    | 406.8 | x | 279.7     | x | 3.3 | 16.02 | x | 11.01 | x | 0.128 |
| 421-33-32350           | FM7540MP        | STEEL     | -----             | 3               | EXT LG    | 406.8 | x | 279.7     | x | 6.0 | 16.02 | x | 11.01 | x | 0.236 |
| 423-33-21240           | FM3829          | PAPER     | 2 PASS            | 18              | INT TH    | 350.0 | x | 77.6      | x | 8.1 | 13.78 | x | 3.06  | x | 0.319 |
| 423-33-21250           | FM6618MP        | STEEL     | -----             | 75              | EXT TH    | 383.0 | x | 276.0     | x | 6.0 | 15.08 | x | 10.87 | x | 0.236 |
| 423-33-21251           | FM6618MP        | STEEL     | -----             | 75              | EXT TH    | 383.0 | x | 276.0     | x | 6.0 | 15.08 | x | 10.87 | x | 0.236 |
| 423-33-31250           | FM7480MP        | STEEL     | -----             | 3               | EXT LG    | 374.6 | x | 266.1     | x | 6.0 | 14.75 | x | 10.48 | x | 0.236 |
| 423-33-31251           | FM7480MP        | STEEL     | -----             | 3               | EXT LG    | 374.6 | x | 266.1     | x | 6.0 | 14.75 | x | 10.48 | x | 0.236 |
| 423-33-31330           | FM7458MP        | STEEL     | -----             | 4               | EXT LG    | 387.6 | x | 266.0     | x | 3.2 | 15.26 | x | 10.47 | x | 0.126 |
| 423-33-31331           | FM7458MP        | STEEL     | -----             | 4               | EXT LG    | 387.6 | x | 266.0     | x | 3.2 | 15.26 | x | 10.47 | x | 0.126 |
| 423-33-31350           | FM7460MP        | STEEL     | -----             | 3               | EXT LG    | 387.9 | x | 266.0     | x | 6.0 | 15.27 | x | 10.47 | x | 0.236 |
| 423-33-31351           | FM7460MP        | STEEL     | -----             | 3               | EXT LG    | 387.9 | x | 266.0     | x | 6.0 | 15.27 | x | 10.47 | x | 0.236 |
| 424-15-12710           | FM4009          | BRONZE    | SPR/WAG           | 90              | INT TH    | 335.0 | x | 264.0     | x | 5.0 | 13.19 | x | 10.39 | x | 0.197 |
| 424-15-12711           | FM4009          | BRONZE    | SPR/WAG           | 90              | INT TH    | 335.0 | x | 264.0     | x | 5.0 | 13.19 | x | 10.39 | x | 0.197 |
| 424-15-12720           | FM4196MP        | STEEL     | -----             | 5               | EXT LG    | 396.5 | x | 280.0     | x | 5.0 | 15.61 | x | 11.02 | x | 0.197 |
| 425-07-3018C1          | FM1836MP        | STEEL     | -----             | 3               | INT LG    | 259.0 | x | 185.7     | x | 6.7 | 10.19 | x | 7.31  | x | 0.262 |
| 425-15-12740           | FM7330MP        | STEEL     | -----             | 6               | EXT LG    | 465.5 | x | 323.1     | x | 5.8 | 18.33 | x | 12.72 | x | 0.228 |
| 425-32-22670           | FM8433          | PAPER     | WAFFLE            | 38              | INT TH    | 250.0 | x | 161.3     | x | 3.2 | 9.84  | x | 6.35  | x | 0.126 |
| 425-32-22680           | FM8436MP        | STEEL     | -----             | 91              | EXT TH    | 277.2 | x | 179.4     | x | 4.0 | 10.91 | x | 7.06  | x | 0.157 |
| 425-33-11510           | FM1787          | PAPER     | 3 PASS            | 112             | INT TH    | 480.1 | x | 329.9     | x | 5.1 | 18.9  | x | 12.99 | x | 0.2   |
| 426-15-12720           | FM8454MP        | STEEL     | -----             | 6               | EXT LG    | 497.5 | x | 344.5     | x | 5.8 | 19.6  | x | 13.6  | x | 0.228 |

| REPLACES<br>OEM PT.NO. | FMC<br>PART NO. | MATERIAL | GROOVE<br>DETAILS | TEETH/<br>TANGS | SIZE MM   |       |   | SIZE INCH |   |     |       |   |       |   |       |
|------------------------|-----------------|----------|-------------------|-----------------|-----------|-------|---|-----------|---|-----|-------|---|-------|---|-------|
| 426-15-22740           | FM7114MP        | STEEL    | -----             | 6               | EXT LG    | 466.9 | x | 323.4     | x | 3.2 | 18.38 | x | 12.73 | x | 0.126 |
| 426-33-31240           | FM7345          | PAPER    | 3 PASS            | 68              | INT TH    | 540.0 | x | 330.0     | x | 5.1 | 21.26 | x | 12.99 | x | 0.2   |
| 426-33-31250           | FM7350MP        | STEEL    | -----             | 112             | EXT TH    | 565.0 | x | 365.0     | x | 2.4 | 22.24 | x | 14.37 | x | 0.094 |
| 42Y-23-H0R10           | FM2811          | PAPER    | 4 PASS            | 34              | INT TH    | 277.0 | x | 167.0     | x | 4.5 | 10.91 | x | 6.57  | x | 0.177 |
| 42Y-23-H0R46           | FM3606MP        | STEEL    | -----             | 88              | (91)EX TH | 293.0 | x | 185.0     | x | 4.0 | 11.54 | x | 7.28  | x | 0.157 |
|                        |                 |          |                   |                 |           |       |   |           |   |     |       |   |       |   |       |
| 42Y-23-H0R47           | FM3608MP        | STEEL    | -----             | 88              | (91)EX TH | 293.0 | x | 185.0     | x | 4.5 | 11.54 | x | 7.28  | x | 0.177 |
| 561-15-42710           | FM3057          | GRAPHITE | SPR/RAD           | 131             | INT TH    | 475.0 | x | 389.0     | x | 5.4 | 18.7  | x | 15.31 | x | 0.213 |
| 561-15-42711           | FM3057          | GRAPHITE | SPR/RAD           | 131             | INT TH    | 475.0 | x | 389.0     | x | 5.4 | 18.7  | x | 15.31 | x | 0.213 |
| 561-15-42720           | FM3061          | GRAPHITE | SPR/RAD           | 120             | INT TH    | 435.0 | x | 356.0     | x | 5.4 | 17.13 | x | 14.02 | x | 0.213 |
| 561-15-42721           | FM3061          | GRAPHITE | SPR/RAD           | 120             | INT TH    | 435.0 | x | 356.0     | x | 5.4 | 17.13 | x | 14.02 | x | 0.213 |
|                        |                 |          |                   |                 |           |       |   |           |   |     |       |   |       |   |       |
| 561-15-42730           | FM3056MP        | STEEL    | -----             | 6               | EXT LG    | 545.0 | x | 401.0     | x | 5.8 | 21.46 | x | 15.79 | x | 0.228 |
| 561-15-42740           | FM3052MP        | STEEL    | -----             | 150             | EXT TH    | 456.0 | x | 367.0     | x | 5.8 | 17.95 | x | 14.45 | x | 0.228 |
| 561-15-42810           | FM3059          | GRAPHITE | SPR/RAD           | 133             | INT TH    | 475.0 | x | 395.0     | x | 5.4 | 18.7  | x | 15.55 | x | 0.213 |
| 561-15-42811           | FM3059          | GRAPHITE | SPR/RAD           | 133             | INT TH    | 475.0 | x | 395.0     | x | 5.4 | 18.7  | x | 15.55 | x | 0.213 |
| 561-15-42820           | FM3054MP        | STEEL    | -----             | 6               | EXT LG    | 545.0 | x | 407.0     | x | 5.8 | 21.46 | x | 16.02 | x | 0.228 |
|                        |                 |          |                   |                 |           |       |   |           |   |     |       |   |       |   |       |
| 561-15-52560           | FM3274MP        | STEEL    | -----             | 6               | EXT LG    | 545.0 | x | 413.0     | x | 4.3 | 21.46 | x | 16.26 | x | 0.169 |
| 561-15-52570           | FM3275          | BRONZE   | OBSOLETE          | 135             | INT TH    | 478.0 | x | 400.0     | x | 5.2 | 18.82 | x | 15.75 | x | 0.205 |
| 561-15-52571           | FM3275          | BRONZE   | OBSOLETE          | 135             | INT TH    | 478.0 | x | 400.0     | x | 5.2 | 18.82 | x | 15.75 | x | 0.205 |
| 561-15-52811           | FM6441          | CARBON   | WAFFLE            | 133             | INT TH    | 475.0 | x | 395.0     | x | 5.4 | 18.7  | x | 15.55 | x | 0.213 |
| 561-15-52930           | FM3054MP        | STEEL    | -----             | 6               | EXT LG    | 545.0 | x | 407.0     | x | 5.8 | 21.46 | x | 16.02 | x | 0.228 |
|                        |                 |          |                   |                 |           |       |   |           |   |     |       |   |       |   |       |
| 561-15-52931           | FM3054MP        | STEEL    | -----             | 6               | EXT LG    | 545.0 | x | 407.0     | x | 5.8 | 21.46 | x | 16.02 | x | 0.228 |
| 561-15-52940           | FM3050MP        | STEEL    | -----             | 6               | EXT LG    | 498.0 | x | 367.0     | x | 5.8 | 19.61 | x | 14.45 | x | 0.228 |
| 561-15-52941           | FM3050MP        | STEEL    | -----             | 6               | EXT LG    | 498.0 | x | 367.0     | x | 5.8 | 19.61 | x | 14.45 | x | 0.228 |
| 561-15-52950           | FM3056MP        | STEEL    | -----             | 6               | EXT LG    | 545.0 | x | 401.0     | x | 5.8 | 21.46 | x | 15.79 | x | 0.228 |
| 561-15-52951           | FM3056MP        | STEEL    | -----             | 6               | EXT LG    | 545.0 | x | 401.0     | x | 5.8 | 21.46 | x | 15.79 | x | 0.228 |
|                        |                 |          |                   |                 |           |       |   |           |   |     |       |   |       |   |       |
| 561-15-52960           | FM3052MP        | STEEL    | -----             | 150             | EXT TH    | 456.0 | x | 367.0     | x | 5.8 | 17.95 | x | 14.45 | x | 0.228 |
| 561-15-52961           | FM3052MP        | STEEL    | -----             | 150             | EXT TH    | 456.0 | x | 367.0     | x | 5.8 | 17.95 | x | 14.45 | x | 0.228 |
| 561-32-71260           | FM6933          | PAPER    | 3 PASS            | 226             | EXT TH    | 680.3 | x | 510.0     | x | 4.4 | 26.78 | x | 20.08 | x | 0.173 |
| 561-33-61230           | FM2674MP        | STEEL    | -----             | 226             | EXT TH    | 681.0 | x | 509.8     | x | 2.4 | 26.81 | x | 20.07 | x | 0.094 |
| 561-33-62260           | FM2675          | CORK     | -----             | 226             | EXT TH    | 681.0 | x | 509.8     | x | 6.9 | 26.81 | x | 20.07 | x | 0.27  |
|                        |                 |          |                   |                 |           |       |   |           |   |     |       |   |       |   |       |
| 561-33-71230           | FM6658MP        | STEEL    | -----             | 157             | EXT TH    | 789.0 | x | 562.0     | x | 2.4 | 31.06 | x | 22.13 | x | 0.094 |
| 561-33-71240           | FM6655          | PAPER    | 3 PASS            | 109             | INT TH    | 760.0 | x | 535.0     | x | 6.5 | 29.92 | x | 21.06 | x | 0.256 |
| 561-33-71260           | FM6937          | PAPER    | DAMPER            | 157             | EXT TH    | 789.0 | x | 562.0     | x | 3.4 | 31.06 | x | 22.13 | x | 0.134 |
| 561-33-71261           | FM6937          | PAPER    | DAMPER            | 157             | EXT TH    | 789.0 | x | 562.0     | x | 3.4 | 31.06 | x | 22.13 | x | 0.134 |
| 561-33-71270           | FM6659          | CORK     | -----             | 157             | EXT TH    | 789.0 | x | 562.0     | x | 6.9 | 31.06 | x | 22.13 | x | 0.272 |
|                        |                 |          |                   |                 |           |       |   |           |   |     |       |   |       |   |       |
| 561-33-71271           | FM6659          | CORK     | -----             | 157             | EXT TH    | 789.0 | x | 562.0     | x | 6.9 | 31.06 | x | 22.13 | x | 0.272 |
| 562-15-12860           | FM2743          | BRONZE   | SPR/WAG           | 146             | INT TH    | 530.2 | x | 434.1     | x | 5.2 | 20.88 | x | 17.09 | x | 0.205 |
| 562-15-22711           | FM2898MP        | STEEL    | -----             | 6               | EXT LG    | 555.0 | x | 386.5     | x | 7.0 | 21.85 | x | 15.22 | x | 0.276 |
| 562-15-22720           | FM6558MP        | STEEL    | -----             | 5               | EXT LG    | 405.7 | x | 278.3     | x | 5.0 | 15.97 | x | 10.96 | x | 0.197 |
| 562-15-22810           | FM8374MP        | STEEL    | -----             | 164             | EXT TH    | 495.3 | x | 402.0     | x | 5.2 | 19.5  | x | 15.83 | x | 0.205 |
|                        |                 |          |                   |                 |           |       |   |           |   |     |       |   |       |   |       |
| 562-15-22820           | FM7426MP        | STEEL    | -----             | 6               | EXT LG    | 615.0 | x | 461.0     | x | 5.8 | 24.21 | x | 18.15 | x | 0.228 |
| 562-15-22830           | FM8372MP        | STEEL    | STEPPED           | 164             | EXT TH    | 495.4 | x | 386.3     | x | 20  | 19.5  | x | 15.21 | x | 0.787 |
| 562-15-22870           | FM7423          | CARBON   | WAFFLE            | 151             | INT TH    | 540.0 | x | 449.0     | x | 5.3 | 21.26 | x | 17.68 | x | 0.207 |
| 562-15-22740           | FM8378MP        | STEEL    | END PLATE         | 6               | EXT LG    | 617.0 | x | 461.2     | x | 8.0 | 24.29 | x | 18.16 | x | 0.315 |
| 562-15-22850           | FM8370MP        | STEEL    | -----             | 164             | EXT TH    | 496.3 | x | 386.1     | x | 5.2 | 19.54 | x | 15.2  | x | 0.205 |
|                        |                 |          |                   |                 |           |       |   |           |   |     |       |   |       |   |       |
| 562-15-22860           | FM8363          | CARBON   | WAFFLE            | 126             | INT TH    | 474.2 | x | 372.7     | x | 5.4 | 18.67 | x | 14.67 | x | 2.13  |
| 562-15-22880           | FM8362MP        | STEEL    | -----             | 5               | EXT LG    | 407.6 | x | 279.7     | x | 5.0 | 16.05 | x | 11.01 | x | 0.197 |
| 562-15-22890           | FM7197          | CARBON   | WAFFLE            | 131             | INT TH    | 475.0 | x | 389.0     | x | 5.4 | 18.7  | x | 15.31 | x | 0.213 |

| REPLACES<br>OEM PT.NO. | FMC<br>PART NO. | MATERIAL | GROOVE<br>DETAILS | TEETH/<br>TANGS | SIZE MM    | SIZE INCH           |                       |
|------------------------|-----------------|----------|-------------------|-----------------|------------|---------------------|-----------------------|
| 562-33-21230           | FM5998MP        | STEEL    | -----             | 182             | (196)EX TH | 984.7 x 695.4 x 3.1 | 38.77 x 27.38 x 0.122 |
| 562-33-21231           | FM5998MP        | STEEL    | -----             | 182             | (196)EX TH | 984.7 x 695.4 x 3.1 | 38.77 x 27.38 x 0.122 |
| 562-33-21240           | FM5995          | PAPER    | 3 PASS            | 136             | INT TH     | 959.5 x 670.6 x 6.7 | 37.78 x 26.4 x 0.264  |
| 562-33-21241           | FM5995          | PAPER    | 3 PASS            | 136             | INT TH     | 959.5 x 670.6 x 6.7 | 37.78 x 26.4 x 0.264  |
| 562-33-21242           | FM5995          | PAPER    | 3 PASS            | 136             | INT TH     | 959.5 x 670.6 x 6.7 | 37.78 x 26.4 x 0.264  |
| 562-33-21260           | FM5999          | CORK     | -----             | 182             | (196)EX TH | 984.7 x 695.4 x 7.8 | 38.77 x 27.38 x 0.307 |
| 562-33-21261           | FM5999          | CORK     | -----             | 182             | (196)EX TH | 984.7 x 695.4 x 7.8 | 38.77 x 27.38 x 0.307 |
| 562-33-21262           | FM5999          | CORK     | -----             | 182             | (196)EX TH | 984.7 x 695.4 x 7.8 | 38.77 x 27.38 x 0.307 |
| 562-33-31240           | FM5995          | PAPER    | 3 PASS            | 136             | INT TH     | 959.5 x 670.6 x 6.7 | 37.78 x 26.4 x 0.264  |
| 562-33-33240           | FM5995          | PAPER    | 3 PASS            | 136             | INT TH     | 959.5 x 670.6 x 6.7 | 37.78 x 26.4 x 0.264  |
| 566-15-12721           | FM2900MP        | STEEL    | -----             | 5               | EXT LG     | 480.0 x 323.5 x 5.0 | 18.9 x 12.74 x 0.197  |
| 566-15-62720           | FM3281          | GRAPHITE | SPR/RAD           | 105             | INT TH     | 375.0 x 311.0 x 5.0 | 14.76 x 12.24 x 0.197 |
| 566-15-62721           | FM3281          | GRAPHITE | SPR/RAD           | 105             | INT TH     | 375.0 x 311.0 x 5.0 | 14.76 x 12.24 x 0.197 |
| 566-15-62731           | FM3288MP        | STEEL    | -----             | 6               | EXT LG     | 448.0 x 322.0 x 5.0 | 17.64 x 12.68 x 0.197 |
| 566-15-62732           | FM3288MP        | STEEL    | -----             | 6               | EXT LG     | 448.0 x 322.0 x 5.0 | 17.64 x 12.68 x 0.197 |
| 566-15-72710           | FM7047          | GRAPHITE | SPR/RAD           | 105             | INT TH     | 383.0 x 310.5 x 5.0 | 15.08 x 12.22 x 0.197 |
| 566-15-72710           | FM6835          | CARBON   | WAFFLE            | 105             | INT TH     | 383.0 x 310.5 x 5.0 | 15.08 x 12.22 x 0.197 |
| 566-33-41230           | FM1790MP        | STEEL    | -----             | 146             | (164)EX TH | 494.8 x 345.9 x 2.4 | 19.48 x 13.62 x 0.094 |
| 566-33-41240           | FM1787          | PAPER    | 3 PASS            | 112             | INT TH     | 480.1 x 329.9 x 5.1 | 18.9 x 12.99 x 0.2    |
| 566-33-41241           | FM1787          | PAPER    | 3 PASS            | 112             | INT TH     | 480.0 x 330.0 x 5.1 | 18.9 x 12.99 x 0.2    |
| 566-33-41242           | FM1787          | PAPER    | 3 PASS            | 112             | INT TH     | 480.0 x 330.0 x 5.1 | 18.9 x 12.99 x 0.2    |
| 566-33-41260           | FM3827          | CORK     | -----             | 146             | EXT TH     | 494.8 x 345.9 x 7.2 | 19.48 x 13.62 x 0.283 |
| 566-33-41261           | FM3827          | CORK     | -----             | 146             | EXT TH     | 494.8 x 345.9 x 7.2 | 19.48 x 13.62 x 0.283 |
| 56D-33-11251           | FM9242MP        | STEEL    | -----             | 148             | EXT TH     | 447.0 x 297.5 x 2.4 | 17.6 x 11.71 x 0.094  |
| 56D-33-11261           | FM9239          | CORK     | -----             | 148             | EXT TH     | 447.0 x 297.5 x 6.9 | 17.6 x 11.71 x 0.272  |
| 56D-33-11271           | FM9237          | PAPER    | 3 PASS            | 148             | EXT TH     | 447.0 x 297.5 x 3.5 | 17.6 x 11.71 x 0.136  |
| 56D-33-11510           | FM9235          | PAPER    | 3 PASS            | 96              | INT TH     | 432.0 x 282.7 x 5.2 | 17.0 x 11.13 x 0.204  |
| 568-15-12721           | FM2898MP        | STEEL    | -----             | 6               | EXT LG     | 555.0 x 386.5 x 7.0 | 21.85 x 15.22 x 0.276 |
| 569-15-32720           | FM3277          | GRAPHITE | SPR/RAD           | 103             | INT TH     | 375.0 x 305.0 x 5.0 | 14.76 x 12.01 x 0.197 |
| 569-15-32721           | FM3277          | GRAPHITE | SPR/RAD           | 103             | INT TH     | 375.0 x 305.0 x 5.0 | 14.76 x 12.01 x 0.197 |
| 569-15-32720           | FM6829          | CARBON   | WAFFLE            | 103             | INT TH     | 375.0 x 305.0 x 5.0 | 14.76 x 12.01 x 0.197 |
| 569-15-32721           | FM6829          | CARBON   | WAFFLE            | 103             | INT TH     | 375.0 x 305.0 x 5.0 | 14.76 x 12.01 x 0.197 |
| 569-15-32730           | FM3050MP        | STEEL    | -----             | 6               | EXT LG     | 498.0 x 367.0 x 5.8 | 19.61 x 14.45 x 0.228 |
| 569-15-32740           | FM3284MP        | STEEL    | -----             | 130             | EXT TH     | 396.0 x 320.0 x 5.0 | 15.59 x 12.6 x 0.197  |
| 569-15-32741           | FM3284MP        | STEEL    | -----             | 130             | EXT TH     | 396.0 x 320.0 x 5.0 | 15.59 x 12.6 x 0.197  |
| 569-15-32810           | FM3279          | GRAPHITE | SPR/RAD           | 124             | INT TH     | 435.0 x 368.0 x 5.5 | 17.13 x 14.49 x 0.197 |
| 569-15-32811           | FM3279          | GRAPHITE | SPR/RAD           | 124             | INT TH     | 435.0 x 368.0 x 5.5 | 17.13 x 14.49 x 0.197 |
| 569-15-32810           | FM6831          | CARBON   | WAFFLE            | 124             | INT TH     | 435.0 x 368.0 x 5.5 | 17.13 x 14.49 x 0.197 |
| 569-15-32811           | FM6831          | CARBON   | WAFFLE            | 124             | INT TH     | 435.0 x 368.0 x 5.5 | 17.13 x 14.49 x 0.197 |
| 569-15-32820           | FM3286MP        | STEEL    | -----             | 6               | EXT LG     | 498.0 x 381.0 x 5.8 | 19.6 x 15.0 x 0.228   |
| 569-15-32821           | FM3286MP        | STEEL    | -----             | 6               | EXT LG     | 498.0 x 381.0 x 5.8 | 19.6 x 15.0 x 0.228   |
| 569-15-32830           | FM7438MP        | STEEL    | -----             | 6               | EXT LG     | 497.4 x 381.5 x 7.3 | 19.58 x 15.02 x 0.287 |
| 569-15-52810           | FM6831          | CARBON   | WAFFLE            | 124             | INT TH     | 435.0 x 368.0 x 5.5 | 17.13 x 14.49 x 0.197 |
| 569-15-52820           | FM7440MP        | STEEL    | -----             | 6               | EXT LG     | 497.0 x 381.0 x 5.0 | 19.57 x 15.0 x 0.197  |
| 569-15-52821           | FM7440MP        | STEEL    | -----             | 6               | EXT LG     | 497.0 x 381.0 x 5.0 | 19.57 x 15.0 x 0.197  |
| 569-15-52830           | FM7199          | CARBON   | WAFFLE            | 120             | INT TH     | 435.0 x 356.0 x 5.4 | 17.13 x 14.02 x 0.213 |
| 569-15-52840           | FM7436MP        | STEEL    | -----             | 6               | EXT LG     | 497.4 x 367.0 x 7.0 | 19.58 x 14.45 x 0.274 |

| REPLACES<br>OEM PT.NO. | FMC<br>PART NO. | MATERIAL             | GROOVE<br>DETAILS | TEETH/<br>TANGS | SIZE MM    | SIZE INCH                                  |
|------------------------|-----------------|----------------------|-------------------|-----------------|------------|--|
| 569-15-52841           | FM7436MP        | STEEL                | -----             | 6               | EXT LG     | 497.4 x 367.0 x 7.0 19.58 x 14.45 x 0.274  |
| 569-15-52850           | FM6829          | CARBON               | WAFFLE            | 103             | INT TH     | 375.0 x 305.0 x 5.0 14.76 x 12.01 x 0.197  |
| 569-15-52860           | FM3284MP        | STEEL                | -----             | 130             | EXT TH     | 396.0 x 320.0 x 5.0 15.59 x 12.6 x 0.197   |
| 569-15-52870           | FM7438MP        | STEEL                | -----             | 6               | EXT LG     | 497.4 x 381.5 x 7.3 19.58 x 15.02 x 0.287  |
| 569-15-52910           | FM6831          | CARBON               | WAFFLE            | 124             | INT TH     | 435.0 x 368.0 x 5.5 17.13 x 14.49 x 0.197  |
| 569-15-52930           | FM7199          | CARBON               | WAFFLE            | 120             | INT TH     | 435.0 x 356.0 x 5.4 17.13 x 14.02 x 0.213  |
| 569-15-52950           | FM6829          | CARBON               | WAFFLE            | 103             | INT TH     | 375.0 x 305.0 x 5.0 14.76 x 12.01 x 0.197  |
| 569-33-41230           | FM2664MP        | STEEL                | -----             | 208             | (226)EX TH | 681.0 x 509.8 x 2.4 26.81 x 20.07 x 0.094  |
| 569-33-41240           | FM2661          | PAPER                | 3 PASS            | 166             | INT TH     | 659.9 x 492.0 x 5.1 25.98 x 19.37 x 0.2    |
| 569-33-41241           | FM2661          | PAPER                | 3 PASS            | 166             | INT TH     | 659.9 x 492.0 x 5.1 25.98 x 19.37 x 0.2    |
| 569-33-41242           | FM2661          | PAPER                | 3 PASS            | 166             | INT TH     | 659.9 x 492.0 x 5.1 25.98 x 19.37 x 0.2    |
| 569-33-41260           | FM2671          | CORK                 | -----             | 208             | (226)EX TH | 681.0 x 509.8 x 6.9 26.81 x 20.07 x 0.27   |
| 569-33-41261           | FM2671          | CORK                 | -----             | 208             | (226)EX TH | 681.0 x 509.8 x 6.9 26.81 x 20.07 x 0.27   |
| 569-33-61240           | FM2661          | PAPER                | 3 PASS            | 166             | INT TH     | 659.9 x 492.0 x 5.1 25.98 x 19.37 x 0.2    |
| 569-33-61241           | FM2661          | PAPER                | 3 PASS            | 166             | INT TH     | 659.9 x 492.0 x 5.1 25.98 x 19.37 x 0.2    |
| 569-33-71260           | FM6975          | PAPER                | DAMPER            | 226             | EXT TH     | 680.6 x 510.0 x 3.5 26.78 x 20.08 x 0.138  |
| 569-33-71280           | FM6936MP        | STEEL                | -----             |                 | RING       | 671.6 x 512.4 x 10.0 26.44 x 20.17 x 0.394 |
| 585-33-21240           | FM5867          | PAPER                | 3 PASS            | 99              | INT TH     | 659.9 x 484.0 x 5.1 25.98 x 19.06 x 0.2    |
| 706-73-91440           | FM5058MP        | STEEL                | -----             | 32              | (34)EX TH  | 134.0 x 97.3 x 1.5 5.27 x 3.85 x 0.059     |
| 706-73-92350           | FM4529          | PAPER                | 2 PASS            | 20              | (23)IN TH  | 120.0 x 88.0 x 3.3 4.72 x 3.46 x 0.13      |
| 706-75-90050           | FM4529          | PAPER                | 2 PASS            | 20              | (23)IN TH  | 120.0 x 88.0 x 3.3 4.72 x 3.46 x 0.13      |
| 706-75-91340           | FM4504MP        | OBSOLETE AFTER STOCK |                   | 38              | (40)EX TH  | 157.0 x 118.0 x 1.5 6.18 x 4.65 x 0.059    |
| 706-75-91350           | FM4501          | OBSOLETE AFTER STOCK |                   | 26              | (29)IN TH  | 144.0 x 109.0 x 3.0 5.67 x 4.29 x 0.118    |
| 706-75-92140           | FM9128MP        | STEEL                | -----             | 6               | EXT LG     | 161.0 x 118.0 x 1.8 6.34 x 4.65 x 0.071    |
| 706-75-92141           | FM9128MP        | STEEL                | -----             | 6               | EXT LG     | 161.0 x 118.0 x 1.8 6.34 x 4.65 x 0.071    |
| 706-75-92150           | FM4679          | PAPER                | 1 PASS            | 26              | (29)IN TH  | 144.0 x 109.0 x 2.5 5.67 x 4.29 x 0.098    |
| 706-75-92350           | FM4679          | PAPER                | 1 PASS            | 26              | (29)IN TH  | 144.0 x 109.0 x 2.5 5.67 x 4.29 x 0.098    |
| 706-77-91540           | FM4690MP        | STEEL                | -----             | 6               | EXT LG     | 187.0 x 137.0 x 3.1 7.36 x 5.39 x 0.122    |
| 706-77-91550           | FM4687          | PAPER                | 2 PASS            | 7               | INT LG     | 176.0 x 135.0 x 4.1 6.93 x 5.31 x 0.161    |
| 706-7G-91340           | FM7582MP        | STEEL                | -----             | 6               | EXT LG     | 170.6 x 129.2 x 2.0 6.72 x 5.09 x 0.079    |
| 706-7G-91350           | FM7579          | PAPER                | 1 PASS            | 29              | INT TH     | 155.0 x 120.0 x 2.5 6.1 x 4.72 x 0.098     |
| 706-7G-91441           | FM9130MP        | STEEL                | -----             | 6               | EXT LG     | 167.5 x 124.0 x 2.0 6.59 x 4.88 x 0.079    |
| 706-7G-91450           | FM9131          | PAPER                | 1 PASS            | 14              | INT LG     | 150.0 x 111.0 x 2.5 5.91 x 4.37 x 0.098    |
| 706-8H-15121           | FM9133          | PAPER                | 2 PASS            | 39              | INT TH     | 183.0 x 158.0 x 1.5 7.2 x 6.22 x 0.059     |
| 706-8H-15130           | FM9136MP        | STEEL                | -----             | 6               | EXT LG     | 196.0 x 157.0 x 2.0 7.72 x 6.18 x 0.079    |
| 708-8F-35120           | FM9137          | PAPER                | 1 PASS            | 6               | INT LG     | 152.0 x 117.0 x 3.0 5.98 x 4.61 x 0.118    |
| 708-85-35230           | FM9140MP        | STEEL                | -----             | 6               | EXT LG     | 171.5 x 131.5 x 2.0 6.75 x 5.18 x 0.079    |
| 708-8H-35120           | FM4671          | PAPER                | 2 PASS            | 6               | INT LG     | 173.0 x 133.0 x 3.0 6.81 x 5.24 x 0.118    |
| 708-8H-35130           | FM5518MP        | STEEL                | -----             | 6               | EXT LG     | 182.0 x 145.5 x 2.6 7.17 x 5.73 x 0.102    |
| 708-8H-35180           | FM4671          | PAPER                | 2 PASS            | 6               | INT LG     | 173.0 x 133.0 x 3.0 6.81 x 5.24 x 0.118    |
| 711-47-11770           | FM5474MP        | STEEL                | -----             |                 | RING       | 85.0 x 70.6 x 3.0 3.45 x 2.78 x 0.118      |
| 712-82-12710           | FM7111          | CARBON               | WAFFLE            | 105             | INT TH     | 400.0 x 309.0 x 5.5 15.75 x 12.17 x 0.215  |
| 712-85-12710           | FM7081          | CARBON               | WAFFLE            | 90              | INT TH     | 335.0 x 265.0 x 5.0 13.19 x 10.43 x 0.197  |
| 712-85-12711           | FM7081          | CARBON               | WAFFLE            | 90              | INT TH     | 335.0 x 265.0 x 5.0 13.19 x 10.43 x 0.197  |
| 712-85-12720           | FM4196MP        | STEEL                | -----             | 5               | EXT LG     | 396.5 x 280.0 x 5.0 15.61 x 11.02 x 0.197  |
| 714-01-11410           | FM4621          | PAPER                | WAFFLE            | 26              | INT TH     | 125.0 x 69.5 x 3.0 4.92 x 2.74 x 0.118     |
| 714-07-12670           | FM3159          | PAPER                | WAFFLE            | 26              | INT TH     | 180.0 x 110.5 x 3.2 7.09 x 4.35 x 0.126    |
| 714-07-12680           | FM3180MP        | STEEL                | -----             | 70              | EXT TH     | 197.9 x 128.0 x 2.0 7.79 x 5.04 x 0.079    |



| REPLACES<br>OEM PT.NO. | FMC<br>PART NO. | MATERIAL  | GROOVE<br>DETAILS | TEETH/<br>TANGS | SIZE MM              | SIZE INCH             |
|------------------------|-----------------|-----------|-------------------|-----------------|----------------------|-----------------------|
| 714-07-12690           | FM3224MP        | STEEL     | -----             | SPRING          | 195.5 x 188.3 x 1.7  | 7.7 x 7.41 x 0.067    |
| 714-07-19710           | FM3159          | PAPER     | WAFFLE            | 26 INT TH       | 180.0 x 110.5 x 3.2  | 7.09 x 4.35 x 0.126   |
| 714-07-19720           | FM3159          | PAPER     | WAFFLE            | 26 INT TH       | 180.0 x 110.5 x 3.2  | 7.09 x 4.35 x 0.126   |
| 714-07-29710           | FM4831          | PAPER     | 2 PASS            | 26 INT TH       | 160.0 x 97.5 x 2.2   | 6.3 x 3.84 x 0.087    |
| 714-07-29720           | FM4831          | PAPER     | 2 PASS            | 26 INT TH       | 160.0 x 97.5 x 2.2   | 6.3 x 3.84 x 0.087    |
| 714-08-19710           | FM4673          | PAPER     | WAFFLE            | 26 INT TH       | 140.0 x 87.0 x 3.0   | 5.51 x 3.43 x 0.118   |
| 714-08-19711           | FM4673          | PAPER     | WAFFLE            | 26 INT TH       | 140.0 x 87.0 x 3.0   | 5.51 x 3.43 x 0.118   |
| 714-08-19730           | FM4676MP        | STEEL     | -----             | 60 EXT TH       | 156.0 x 99.0 x 1.8   | 6.14 x 3.9 x 0.071    |
| 714-10-19730           | FM4624MP        | STEEL     | -----             | 51 EXT TH       | 131.5 x 80.0 x 1.8   | 5.18 x 3.15 x 0.071   |
| 714-12-19710           | FM4831          | PAPER     | 2 PASS            | 26 INT TH       | 160.0 x 97.5 x 2.2   | 6.3 x 3.84 x 0.087    |
| 714-12-19711           | FM4831          | PAPER     | 2 PASS            | 26 INT TH       | 160.0 x 97.5 x 2.2   | 6.3 x 3.84 x 0.087    |
| 714-12-19730           | FM3716MP        | STEEL     | -----             | 70 EXT TH       | 197.9 x 128.0 x 4.0  | 7.79 x 5.04 x 0.157   |
| 714-16-19730           | FM2914MP        | STEEL     | -----             | 68 EXT TH       | 174.1 x 110.0 x 1.7  | 6.85 x 4.33 x 0.066   |
| 772-05-02570           | FM3177          | PAPER     | WAFFLE            | 26 INT TH       | 160.0 x 97.5 x 2.2   | 6.3 x 3.84 x 0.087    |
| 772-05-02590           | FM3177          | PAPER     | WAFFLE            | 26 INT TH       | 160.0 x 97.5 x 2.2   | 6.3 x 3.84 x 0.087    |
| 772-10-12590           | FM2911          | PAPER     | WAFFLE            | 26 INT TH       | 160.0 x 97.5 x 2.2   | 6.3 x 3.84 x 0.087    |
| 772-10-12720           | FM2914MP        | STEEL     | -----             | 68 EXT TH       | 174.1 x 110.0 x 1.7  | 6.85 x 4.33 x 0.066   |
| AS35157213010          | FM5856MP        | STEEL     | END PLATE         | 6 EXT LG        | 143.3 x 88.4 x 7.6   | 5.64 x 3.48 x 0.3     |
| AS35633-3400           | FM3358MP        | STEEL     | -----             | 6 EXT LG        | 143.5 x 88.5 x 2.0   | 5.65 x 3.48 x 0.079   |
| AS35634-3400           | FM3561          | PAPER     | WAFFLE            | 30 INT TH       | 131.0 x 79.2 x 2.6   | 5.16 x 3.12 x 0.102   |
| EH5306                 | FM6502MP        | STEEL     | -----             | 237 EXT TH      | 1189.0 x 865.0 x 3.7 | 46.81 x 34.06 x 0.146 |
| EH5307                 | FM6499          | CARBON PA | 3 PASS            | 168 INT TH      | 1164.0 x 830.0 x 7.7 | 45.83 x 32.68 x 0.301 |
| EH5308                 | FM6501          | CORK      | -----             | 237 EXT TH      | 1189.0 x 865.0 x 8.4 | 46.81 x 34.06 x 0.331 |
| EM8365                 | FM6502MP        | STEEL     | -----             | 237 EXT TH      | 1189.0 x 865.0 x 3.7 | 46.81 x 34.06 x 0.146 |
| EM8366                 | FM6499          | CARBON PA | 3 PASS            | 168 INT TH      | 1164.0 x 830.0 x 7.7 | 45.83 x 32.68 x 0.301 |
| EM8367                 | FM6501          | CORK      | -----             | 237 EXT TH      | 1189.0 x 865.0 x 8.4 | 46.81 x 34.06 x 0.331 |
| VE1304                 | FM8805          | CARBON PA | 2 PASS            | 45 INT TH       | 266.5 x 187.2 x 2.8  | 10.49 x 7.37 x 0.11   |
| VE1305                 | FM8808MP        | STEEL     | -----             | 8 EXT TH        | 281.9 x 200.1 x 3.1  | 11.1 x 7.88 x 0.122   |
| <b>KRAMER</b>          |                 |           |                   |                 |                      |                       |
| 803770                 | FM4844MP        | STEEL     | -----             | 67 (70)EX TH    | 191.0 x 130.0 x 2.0  | 7.52 x 5.12 x 0.079   |
| 803773                 | FM3575          | PAPER     | 3 PASS            | 35 INT TH       | 179.0 x 103.0 x 3.5  | 7.05 x 4.05 x 0.138   |
| 212120215              | FM6901          | BRONZE    | WAFFLE            | 6 EXT LG        | 136.4 x 92.0 x 2.4   | 5.37 x 3.62 x 0.094   |
| 212120315              | FM6904MP        | STEEL     | -----             | 21 INT TH       | 122.6 x 82.1 x 1.5   | 4.83 x 3.23 x 0.059   |
| 1000035878             | FM6901          | BRONZE    | WAFFLE            | 6 EXT LG        | 136.4 x 92.0 x 2.4   | 5.37 x 3.62 x 0.094   |
| 1000035880             | FM6904MP        | STEEL     | -----             | 21 INT TH       | 122.6 x 82.1 x 1.5   | 4.83 x 3.23 x 0.059   |
| 1000089319             | FM2823          | PAPER     | 2 PASS            | 36 INT TH       | 223.0 x 71.0 x 4.9   | 8.78 x 2.8 x 0.191    |
| 1000089320             | FM3912MP        | END PLATE | -----             | 64 EXT TH       | 230.0 x 152.5 x 5.0  | 9.06 x 6.0 x 0.197    |
| 1000098261             | FM3474MP        | STEEL     | -----             | 4 EXT LG        | 85.0 x 49.2 x 1.5    | 3.35 x 1.94 x 0.059   |
| 1000098262             | FM2969          | BRONZE    | WAFFLE            | 22 INT TH       | 71.7 x 44.0 x 1.6    | 2.82 x 1.73 x 0.063   |
| 1000108546             | FM9485          | GRAPHITE  | SUNBURST          | 12 INT TH       | 170.0 x 32.7 x 4.8   | 6.69 x 1.29 x 0.189   |
| 1000150552             | FM4625          | PAPER     | SUNBURST          | 16 INT TH       | 201.0 x 40.5 x 4.9   | 7.91 x 1.59 x 0.192   |
| 1000150553             | FM4606MP        | STEEL     | -----             | 3 EXT LG        | 216.9 x 144.0 x 2.7  | 8.54 x 5.67 x 0.106   |

| REPLACES<br>OEM PT.NO. | FMC<br>PART NO. | MATERIAL | GROOVE<br>DETAILS | TEETH/<br>TANGS |        | SIZE MM |   |       | SIZE INCH |     |       |   |      |   |       |
|------------------------|-----------------|----------|-------------------|-----------------|--------|---------|---|-------|-----------|-----|-------|---|------|---|-------|
| <b>KUBOTA</b>          |                 |          |                   |                 |        |         |   |       |           |     |       |   |      |   |       |
| 3C081-65180            | FM6711          | PAPER    | WAFFLE            | 20              | INT TH | 244.0   | x | 50.3  | x         | 4.3 | 9.61  | x | 1.98 | x | 0.167 |
| 3G700-4012-1           | FM4274MP        | STEEL    | -----             | 61              | EXT TH | 131.2   | x | 99.0  | x         | 1.8 | 5.17  | x | 3.9  | x | 0.071 |
| 6C090-22340            | FM5360MP        | STEEL    | -----             | 12              | EXT SL | 117.0   | x | 60.0  | x         | 2.0 | 4.61  | x | 2.36 | x | 0.079 |
| 6C090-22350            | FM5357          | PAPER    | -----             | 13              | INT TH | 109.5   | x | 26.0  | x         | 3.4 | 4.31  | x | 1.02 | x | 0.134 |
| 6C140-22340            | FM5360MP        | STEEL    | -----             | 12              | EXT SL | 117.0   | x | 60.0  | x         | 2.0 | 4.61  | x | 2.36 | x | 0.079 |
| 6C140-22350            | FM5357          | PAPER    | -----             | 13              | INT TH | 109.5   | x | 26.0  | x         | 3.4 | 4.31  | x | 1.02 | x | 0.134 |
| 32530-28280            | FM6711          | PAPER    | WAFFLE            | 20              | INT TH | 244.0   | x | 50.3  | x         | 4.3 | 9.61  | x | 1.98 | x | 0.167 |
| 32530-28281            | FM6711          | PAPER    | WAFFLE            | 20              | INT TH | 244.0   | x | 50.3  | x         | 4.3 | 9.61  | x | 1.98 | x | 0.167 |
| 36200-85131            | FM6714MP        | STEEL    | -----             | 6               | EXT SL | 268.0   | x | 170.0 | x         | 2.3 | 10.55 | x | 6.69 | x | 0.091 |
| 36330-65133            | FM6714MP        | STEEL    | -----             | 6               | EXT SL | 268.0   | x | 170.0 | x         | 2.3 | 10.55 | x | 6.69 | x | 0.091 |
| 36530-2713-1           | FM7755          | PAPER    | 2 PASS            | 33              | INT TH | 134.6   | x | 83.2  | x         | 2.2 | 5.3   | x | 3.28 | x | 0.087 |
| 36530-2714-1           | FM7758MP        | STEEL    | -----             | 6               | EXT LG | 147.8   | x | 94.1  | x         | 2.0 | 5.82  | x | 3.7  | x | 0.079 |
| 36602-23681            | FM3509          | BRONZE   | SPR/WAG           | 36              | INT TH | 133.5   | x | 90.0  | x         | 2.5 | 5.26  | x | 3.54 | x | 0.098 |
| 36602-23691            | FM2502B         | STEEL    | -----             | 54              | EXT TH | 139.5   | x | 98.5  | x         | 1.8 | 5.49  | x | 3.88 | x | 0.069 |
| 36602-23911            | FM3509          | BRONZE   | SPR/WAG           | 36              | INT TH | 133.5   | x | 90.0  | x         | 2.5 | 5.26  | x | 3.54 | x | 0.098 |
| 37720-28170            | FM5364MP        | STEEL    | -----             | 4               | EXT LG | 240.0   | x | 152.0 | x         | 2.6 | 9.45  | x | 5.98 | x | 0.1   |
| T1060-28200            | FM5361          | PAPER    | 2 PASS            | 16              | INT TH | 210.0   | x | 40.0  | x         | 4.7 | 8.27  | x | 1.57 | x | 0.185 |
| CARR-110642            | FM2971          | BRONZE   | WAFFLE            | 22              | INT TH | 71.7    | x | 44.0  | x         | 2.8 | 2.82  | x | 1.73 | x | 0.11  |
| CARR-110643            | FM3474MP        | STEEL    | -----             | 4               | EXT LG | 85.0    | x | 49.2  | x         | 1.5 | 3.35  | x | 1.94 | x | 0.059 |
| CARR-110644            | FM2969          | BRONZE   | WAFFLE            | 22              | INT TH | 71.7    | x | 44.0  | x         | 1.6 | 2.82  | x | 1.73 | x | 0.063 |

| REPLACES<br>OEM PT.NO.         | FMC<br>PART NO. | MATERIAL  | GROOVE<br>DETAILS | TEETH/<br>TANGS | SIZE MM |       |   |       | SIZE INCH |     |       |   |      |   |       |
|--------------------------------|-----------------|-----------|-------------------|-----------------|---------|-------|---|-------|-----------|-----|-------|---|------|---|-------|
| <b>LANCER BOSS (STEINBOCK)</b> |                 |           |                   |                 |         |       |   |       |           |     |       |   |      |   |       |
| 7176811                        | FM3382KIT       | STEEL     | FLEXI PLATE       |                 |         |       |   |       |           |     |       |   |      |   |       |
| 8534954                        | FM0177          | BRONZE    | SUNBURST          | 38              | INT TH  | 163.3 | x | 92.7  | x         | 2.4 | 6.43  | x | 3.65 | x | 0.095 |
| 8556301                        | FM2710MP        | STEEL     | -----             | 52              | INT TH  | 177.8 | x | 128.2 | x         | 2.3 | 7.0   | x | 5.05 | x | 0.091 |
| 8576361                        | FM1649          | PAPER     | 2 PASS            | 45              | INT TH  | 133.1 | x | 92.7  | x         | 1.6 | 5.24  | x | 3.65 | x | 0.063 |
| 8556563                        | FM2704MP        | STEEL     | -----             | 64              | INT TH  | 228.6 | x | 158.7 | x         | 2.6 | 9.0   | x | 6.25 | x | 0.102 |
| 8657891                        | FM2705B         | BRONZE    | SUNBURST          | 93              | EXT TH  | 239.8 | x | 171.6 | x         | 3.5 | 9.44  | x | 6.76 | x | 0.138 |
| 8665904                        | FM1279          | PAPER     | 2 PASS            | 52              | INT TH  | 148.6 | x | 107.7 | x         | 1.8 | 5.85  | x | 4.24 | x | 0.07  |
| 8665912                        | FM1216MP        | STEEL     | -----             | 60              | EXT TH  | 154.2 | x | 113.8 | x         | 1.8 | 6.07  | x | 4.48 | x | 0.07  |
| 8668988                        | FM3650MP        | STEEL     | -----             | 54              | EXT TH  | 139.2 | x | 98.6  | x         | 3.0 | 5.48  | x | 3.88 | x | 0.118 |
| 8668996                        | FM2829          | PAPER     | 2 PASS            | 45              | INT TH  | 133.1 | x | 92.7  | x         | 2.1 | 5.24  | x | 3.65 | x | 0.083 |
| 8699119                        | FM1381OE        | BRONZE    | RADIAL            | 52              | INT TH  | 148.6 | x | 107.7 | x         | 2.9 | 5.85  | x | 4.24 | x | 0.114 |
| 8699199                        | FM1381OE        | BRONZE    | RADIAL            | 52              | INT TH  | 148.6 | x | 107.7 | x         | 2.9 | 5.85  | x | 4.24 | x | 0.114 |
| 8755951                        | FM2829          | PAPER     | 2 PASS            | 45              | INT TH  | 133.1 | x | 92.7  | x         | 2.1 | 5.24  | x | 3.65 | x | 0.083 |
| 8755978                        | FM3650MP        | STEEL     | -----             | 54              | EXT TH  | 139.2 | x | 98.6  | x         | 3.0 | 5.48  | x | 3.88 | x | 0.118 |
| 8827661                        | FM1324MP        | STEEL     | -----             | 54              | EXT TH  | 139.2 | x | 98.6  | x         | 1.8 | 5.48  | x | 3.88 | x | 0.07  |
| 8827688                        | FM3615          | PAPER     | WAFFLE            | 45              | INT TH  | 133.1 | x | 92.7  | x         | 2.4 | 5.24  | x | 3.65 | x | 0.096 |
| 9104452                        | FM1801          | BRONZE    | WAFFLE            | 76              | EXT TH  | 164.1 | x | 103.1 | x         | 2.8 | 6.46  | x | 4.06 | x | 0.11  |
| 9104559                        | FM1220MP        | STEEL     | -----             | 40              | INT TH  | 152.4 | x | 82.3  | x         | 1.6 | 6.0   | x | 3.24 | x | 0.063 |
| 9104727                        | FM1302MP        | STEEL     | -----             | 64              | EXT TH  | 137.2 | x | 96.3  | x         | 1.5 | 5.4   | x | 3.79 | x | 0.059 |
| 9105615                        | FM1288MP        | STEEL     | -----             | 79              | EXT TH  | 168.7 | x | 104.1 | x         | 1.5 | 6.64  | x | 4.1  | x | 0.059 |
| 9107565                        | FM2707          | BRONZE    | WAFFLE            | 88              | EXT TH  | 189.4 | x | 141.7 | x         | 3.1 | 7.46  | x | 5.58 | x | 0.122 |
| 9107960                        | FM2705B         | BRONZE    | SUNBURST          | 93              | EXT TH  | 239.8 | x | 171.6 | x         | 3.5 | 9.44  | x | 6.76 | x | 0.138 |
| 9167453                        | FM4442FP        | STEEL     | REINF PLATE       | 6               | HOLE    | 186.5 | x | 132.0 | x         | 2.1 | 7.34  | x | 5.2  | x | 0.83  |
| 9167456                        | FM4442FP        | STEEL     | REINF PLATE       | 6               | HOLE    | 186.5 | x | 132.0 | x         | 2.1 | 7.34  | x | 5.2  | x | 0.83  |
| 9167461                        | FM3382FP        | STEEL     | FLEXI PLATE       | 6               | HOLE    | 339.7 | x | 133.4 | x         | 1.5 | 13.37 | x | 5.25 | x | 0.059 |
| 9403519                        | FM2858MP        | STEEL     | -----             | 6               | EXT TH  | 274.3 | x | 201.9 | x         | 2.7 | 10.8  | x | 7.95 | x | 0.107 |
| 9403527                        | FM1965          | BRONZE    | SPR/WAG           | 60              | INT TH  | 253.5 | x | 187.7 | x         | 3.9 | 9.98  | x | 7.39 | x | 0.153 |
| 9425283                        | FM1389          | BRONZE    | SPIRAL            | 57              | INT TH  | 128.3 | x | 87.9  | x         | 2.5 | 5.05  | x | 3.46 | x | 0.098 |
| <b>LANDINI</b>                 |                 |           |                   |                 |         |       |   |       |           |     |       |   |      |   |       |
| 514754M91                      | OBSOLETE        | BRONZE    | -----             | 27              | INT TH  | 241.0 | x | 110.0 | x         | 3.0 | 9.49  | x | 4.33 | x | 0.118 |
| 975743M1                       | FM5862MP        | STEEL     | HARD/BLACK        | 21              | INT TH  | 229.0 | x | 171.0 | x         | 2.0 | 9.01  | x | 6.73 | x | 0.078 |
| 3300184M1                      | FM7508MP        | STEEL     | -----             | 65              | INT TH  | 259.8 | x | 190.0 | x         | 2.0 | 10.23 | x | 7.48 | x | 0.079 |
| 3302840M1                      | OBSOLETE        | STEEL     | -----             | 14              | INT TH  | 152.0 | x | 41.0  | x         | 2.5 | 5.98  | x | 1.61 | x | 0.098 |
| 3304635M2                      | FM2023          | BRONZE    | SPR/WAG           | 23              | INT TH  | 177.8 | x | 43.9  | x         | 4.8 | 7.0   | x | 1.73 | x | 0.19  |
| 3304636M1                      | FM1284MP        | STEEL     | -----             | 1               | EXT LG  | 182.9 | x | 82.6  | x         | 2.7 | 7.2   | x | 3.25 | x | 0.106 |
| 3308295M2                      | FM3841          | PAPER     | 2 PASS            | 23              | INT TH  | 178.0 | x | 44.0  | x         | 4.8 | 7.01  | x | 1.73 | x | 0.189 |
| 3308296M2                      | FM3844MP        | STEEL     | -----             | 1               | EXT LG  | 184.0 | x | 114.0 | x         | 2.6 | 7.24  | x | 4.49 | x | 0.102 |
| 3535759M1                      | FM5862MP        | STEEL     | HARD/BLACK        | 21              | INT TH  | 229.0 | x | 171.0 | x         | 2.0 | 9.01  | x | 6.73 | x | 0.078 |
| 3535760M91                     | OBSOLETE        | GRAPHITE  | -----             | 28              | EXT TH  | 239.0 | x | 180.0 | x         | 4.0 | 9.41  | x | 7.09 | x | 0.157 |
| 3538837M1                      | FM7601          | GRAPHITE  | -----             | 27              | INT TH  | 224.0 | x | 55.0  | x         | 4.8 | 8.82  | x | 2.17 | x | 0.189 |
| 3538838M1                      | FM7604MP        | OBSOLETE  | -----             | 1               | EXT LG  | 228.0 | x | 150.0 | x         | 2.7 | 8.98  | x | 5.91 | x | 0.104 |
| 3550896M1                      | FM3841          | PAPER     | 2 PASS            | 23              | INT TH  | 178.0 | x | 44.0  | x         | 4.8 | 7.01  | x | 1.73 | x | 0.189 |
| 3558371M1                      | FM9455          | CARBON PA | WAFFLE            | 58              | INT TH  | 199.9 | x | 139.0 | x         | 2.5 | 7.87  | x | 5.47 | x | 0.098 |
| 3558372M1                      | FM9455          | CARBON PA | WAFFLE            | 58              | INT TH  | 199.9 | x | 139.0 | x         | 2.5 | 7.87  | x | 5.47 | x | 0.098 |
| 3558408M1                      | FM9458MP        | STEEL     | -----             | 6               | EXT LG  | 218.0 | x | 147.5 | x         | 4.0 | 8.58  | x | 5.81 | x | 0.157 |

| REPLACES OEM PT.NO.     |          | FMC PART NO. | MATERIAL | GROOVE DETAILS | TEETH/TANGS |       | SIZE MM |       |   | SIZE INCH |       |   |      |   |       |
|-------------------------|----------|--------------|----------|----------------|-------------|-------|---------|-------|---|-----------|-------|---|------|---|-------|
| 3693937M1               | FM3095   | GRAPHITE     | SUNBURST | 13             | INT TH      | 215.0 | x       | 36.5  | x | 10.0      | 8.46  | x | 1.44 | x | 0.394 |
| 3694567M1               | FM2971   | BRONZE       | WAFFLE   | 22             | INT TH      | 71.7  | x       | 44.0  | x | 2.8       | 2.82  | x | 1.73 | x | 0.11  |
| <b>LANSING</b>          |          |              |          |                |             |       |         |       |   |           |       |   |      |   |       |
| T004-001-127            | FM1389   | BRONZE       | SPIRAL   | 57             | INT TH      | 128.3 | x       | 87.9  | x | 2.5       | 5.05  | x | 3.46 | x | 0.098 |
| T005-001-128            | FM1302MP | STEEL        | -----    | 64             | EXT TH      | 137.2 | x       | 96.3  | x | 1.5       | 5.4   | x | 3.79 | x | 0.059 |
| T012-001-166            | FM1801   | BRONZE       | WAFFLE   | 76             | EXT TH      | 164.1 | x       | 103.1 | x | 2.8       | 6.46  | x | 4.06 | x | 0.11  |
| T012-001-170            | FM1220MP | STEEL        | -----    | 40             | INT TH      | 152.4 | x       | 82.3  | x | 1.6       | 6.0   | x | 3.24 | x | 0.063 |
| T719-001-170            | FM1220MP | STEEL        | -----    | 40             | INT TH      | 152.4 | x       | 82.3  | x | 1.6       | 6.0   | x | 3.24 | x | 0.063 |
| T735-001-039            | FM3650MP | STEEL        | -----    | 54             | EXT TH      | 139.2 | x       | 98.6  | x | 3.0       | 5.48  | x | 3.88 | x | 0.118 |
| T735-001-040            | FM2829   | PAPER        | 2 PASS   | 45             | INT TH      | 133.1 | x       | 92.7  | x | 2.1       | 5.24  | x | 3.65 | x | 0.083 |
| 1036-328-001            | FM1900MP | STEEL        | -----    | 64             | EXT TH      | 205.5 | x       | 145.3 | x | 1.7       | 8.09  | x | 5.72 | x | 0.067 |
| 1036-329-001            | FM1247OE | BRONZE       | SUNBURST | 43             | (44)INT TH  | 196.9 | x       | 137.7 | x | 2.8       | 7.75  | x | 5.42 | x | 0.109 |
| <b>LE TOURNEAU</b>      |          |              |          |                |             |       |         |       |   |           |       |   |      |   |       |
| DC 9047                 | FM0191   | BRONZE       | -----    | 39             | EXT TH      | 171.0 | x       | 114.0 | x | 4.3       | 6.73  | x | 4.49 | x | 0.169 |
| DC 9049                 | TBA      | OBSOLETE     | -----    | 55             | EXT TH      | 239.0 | x       | 163.1 | x | 4.3       | 9.41  | x | 6.42 | x | 0.169 |
| TC 6397                 | TBA      | OBSOLETE     | -----    | 55             | EXT TH      | 239.0 | x       | 163.1 | x | 4.3       | 9.41  | x | 6.42 | x | 0.169 |
| <b>LEYLAND (WILSON)</b> |          |              |          |                |             |       |         |       |   |           |       |   |      |   |       |
| 500049                  | FM1222MP | STEEL        | -----    | 44             | INT TH      | 198.1 | x       | 125.7 | x | 3.0       | 7.8   | x | 4.95 | x | 0.118 |
| 500050                  | FM1113   | BRONZE       | SPIRAL   | 69             | EXT TH      | 210.8 | x       | 142.2 | x | 3.2       | 8.3   | x | 5.6  | x | 0.125 |
| 577242/3                | FM1113   | BRONZE       | SPIRAL   | 69             | EXT TH      | 210.8 | x       | 142.2 | x | 3.2       | 8.3   | x | 5.6  | x | 0.125 |
| 599516                  | FM1113   | BRONZE       | SPIRAL   | 69             | EXT TH      | 210.8 | x       | 142.2 | x | 3.2       | 8.3   | x | 5.6  | x | 0.125 |
| 817803                  | FM1113   | BRONZE       | SPIRAL   | 69             | EXT TH      | 210.8 | x       | 142.2 | x | 3.2       | 8.3   | x | 5.6  | x | 0.125 |
| 820746                  | FM1113   | BRONZE       | SPIRAL   | 69             | EXT TH      | 210.8 | x       | 142.2 | x | 3.2       | 8.3   | x | 5.6  | x | 0.125 |
| 821516                  | FM1113   | BRONZE       | SPIRAL   | 69             | EXT TH      | 210.8 | x       | 142.2 | x | 3.2       | 8.3   | x | 5.6  | x | 0.125 |
| 842452                  | FM1222MP | STEEL        | -----    | 44             | INT TH      | 198.1 | x       | 125.7 | x | 3.0       | 7.8   | x | 4.95 | x | 0.118 |
| 842458                  | FM1113   | BRONZE       | SPIRAL   | 69             | EXT TH      | 210.8 | x       | 142.2 | x | 3.2       | 8.3   | x | 5.6  | x | 0.125 |
| 50357317                | FM1113   | BRONZE       | SPIRAL   | 69             | EXT TH      | 210.8 | x       | 142.2 | x | 3.2       | 8.3   | x | 5.6  | x | 0.125 |
| CBL2433                 | FM1113   | BRONZE       | SPIRAL   | 69             | EXT TH      | 210.8 | x       | 142.2 | x | 3.2       | 8.3   | x | 5.6  | x | 0.125 |
| CBL3861                 | FM1071   | OBSOLETE     | SUNBURST | 69             | EXT TH      | 210.8 | x       | 142.2 | x | 3.2       | 8.3   | x | 5.6  | x | 0.125 |
| NAK2746                 | FM1343   | OBSOLETE     | WAFFLE   | 12             | INT LG      | 273.1 | x       | 230.9 | x | 5.6       | 10.75 | x | 9.09 | x | 0.22  |
| NLK8637                 | FM1343   | OBSOLETE     | WAFFLE   | 12             | INT LG      | 273.1 | x       | 230.9 | x | 5.6       | 10.75 | x | 9.09 | x | 0.22  |
| RLK2012                 | FM1343   | OBSOLETE     | WAFFLE   | 12             | INT LG      | 273.1 | x       | 230.9 | x | 5.6       | 10.75 | x | 9.09 | x | 0.22  |
| 37H8181                 | FM1204MP | STEEL        | -----    | 1              | EXT LG      | 228.6 | x       | 127.0 | x | 2.7       | 9     | x | 5    | x | 0.106 |
| 37H8457                 | FM1591   | BRONZE       | SPR/WAG  | 22             | INT TH      | 224.0 | x       | 53.3  | x | 4.8       | 8.82  | x | 2.1  | x | 0.19  |
| NTT32                   | FM1202MP | STEEL        | -----    | 1              | EXT LG      | 209.3 | x       | 114.3 | x | 2.7       | 8.24  | x | 4.5  | x | 0.106 |
| NTT33                   | FM1705   | BRONZE       | SPR/WAG  | 22             | INT TH      | 204.5 | x       | 53.3  | x | 4.8       | 8.05  | x | 2.1  | x | 0.19  |
| <b>LIEBHERR</b>         |          |              |          |                |             |       |         |       |   |           |       |   |      |   |       |
| 50 04 457               | FM3998MP | STEEL        | "M"      | 45             | EXT TH      | 281.0 | x       | 221.0 | x | 3.0       | 11.05 | x | 8.7  | x | 0.118 |
| 50 04 469               | FM3992MP | STEEL        | HOLES    | 24             | (32)EX TH   | 306.0 | x       | 237.0 | x | 3.0       | 12.03 | x | 9.3  | x | 0.118 |
| 50 04 485               | FM3892MP | STEEL        | 8 HOLES  | 24             | (32)EX TH   | 306.0 | x       | 247.0 | x | 2.0       | 12.03 | x | 9.72 | x | 0.079 |
| 50 05 784               | FM3602MP | STEEL        | -----    | 35             | INT TH      | 170.9 | x       | 102.9 | x | 2.0       | 6.73  | x | 4.05 | x | 0.079 |
| 50 06 242               | FM3988MP | STEEL        | HOLES    | 24             | (32)EX TH   | 306.0 | x       | 237.0 | x | 2.0       | 12.03 | x | 9.3  | x | 0.079 |
| 50 07 177               | FM2279   | BRONZE       | SUNBURST | 35             | EXT TH      | 177.5 | x       | 109.0 | x | 2.0       | 6.99  | x | 4.29 | x | 0.079 |

| REPLACES<br>OEM PT.NO. | FMC<br>PART NO. | MATERIAL   | GROOVE<br>DETAILS | TEETH/<br>TANGS | SIZE MM   |       |   | SIZE INCH |   |     |       |   |       |   |       |
|------------------------|-----------------|------------|-------------------|-----------------|-----------|-------|---|-----------|---|-----|-------|---|-------|---|-------|
| 50 07 178              | FM3604MP        | STEEL      | -----             | 35              | INT TH    | 170.9 | x | 102.9     | x | 2.5 | 6.73  | x | 4.05  | x | 0.098 |
| 57 02 743              | FM3592MP        | STEEL      | -----             | 29              | INT TH    | 131.1 | x | 85.1      | x | 1.5 | 5.16  | x | 3.35  | x | 0.059 |
| 57 11 042              | FM4125          | BRONZE     | SUN-PLAIN         | 35              | EXT TH    | 177.5 | x | 109.0     | x | 1.6 | 6.99  | x | 4.29  | x | 0.063 |
| 57 14 441              | FM4397          | BRONZE     | SUNBURST          | 64              | EXT TH    | 196.0 | x | 142.0     | x | 2.5 | 7.72  | x | 5.59  | x | 0.096 |
| 57 14 442              | FM4399          | BRNZ/PLN   | SUNBURST          | 64              | EXT TH    | 196.0 | x | 142.0     | x | 2.0 | 7.72  | x | 5.59  | x | 0.077 |
| 70 08 345              | FM4650MP        | STEEL      | -----             | 24              | EXT TH    | 108.2 | x | 76.2      | x | 1.2 | 4.26  | x | 3.0   | x | 0.045 |
| 70 08 346              | FM4646MP        | STEEL      | -----             | 12              | EXT TH    | 156.0 | x | 119.2     | x | 1.2 | 6.14  | x | 4.69  | x | 0.045 |
| 70 09 149              | FM4451          | MOLYBDENUM | SPR/WAG           | 46              | (50)IN TH | 117.5 | x | 62.6      | x | 2.6 | 4.63  | x | 2.46  | x | 0.102 |
| 70 09 153              | FM4666-2.2      | STEEL      | HARDENED          | 6               | EXT SL    | 130.0 | x | 66.8      | x | 2.2 | 5.12  | x | 2.63  | x | 0.087 |
| 70 09 255              | FM3606MP        | STEEL      | -----             | 88              | (91)EX TH | 293.0 | x | 185.0     | x | 4.0 | 11.54 | x | 7.28  | x | 0.157 |
| 70 09 642              | FM3594MP        | STEEL      | -----             | 29              | INT TH    | 131.1 | x | 85.1      | x | 2.0 | 5.16  | x | 3.35  | x | 0.079 |
| 70 11 448              | FM3596MP        | STEEL      | -----             | 29              | INT TH    | 131.1 | x | 85.1      | x | 2.5 | 5.16  | x | 3.35  | x | 0.098 |
| 70 11 449              | FM2277          | BRONZE     | SUNBURST          | 27              | EXT TH    | 137.4 | x | 90.9      | x | 2.0 | 5.41  | x | 3.58  | x | 0.079 |
| 70 12 018              | FM6644MP        | STEEL      | HARDENED          | 10              | EXT SL    | 212.4 | x | 178.2     | x | 1.8 | 8.36  | x | 7.02  | x | 0.069 |
| 70 12 047              | FM6645          | BRONZE     | SPR/RAD           | 32              | INT TH    | 196.0 | x | 157.0     | x | 2.2 | 7.72  | x | 6.18  | x | 0.087 |
| 70 12 048              | FM6648MP        | STEEL      | HARDENED          | 10              | EXT SL    | 212.4 | x | 164.2     | x | 1.8 | 8.36  | x | 6.46  | x | 0.069 |
| 70 13 332              | FM4647          | BRONZE     | SPR/RAD           | 34              | INT TH    | 100.0 | x | 68.2      | x | 1.6 | 3.94  | x | 2.69  | x | 0.061 |
| 70 13 335              | FM4643          | BRONZE     | SPR/RAD           | 24              | INT TH    | 143.0 | x | 109.8     | x | 1.6 | 5.63  | x | 4.32  | x | 0.061 |
| 70 15 912              | FM7038MP        | STEEL      | HARD/BLACK        | 64              | EXT TH    | 196.4 | x | 140.0     | x | 2.9 | 7.73  | x | 5.51  | x | 0.114 |
| 70 15 914              | FM7038-3.5      | STEEL      | HARD/BLACK        | 64              | EXT TH    | 196.4 | x | 140.0     | x | 3.5 | 7.73  | x | 5.51  | x | 0.138 |
| 70 15 915              | FM4933          | BRONZE     | WAF/WAG           | 45              | INT TH    | 187.0 | x | 132.6     | x | 3.0 | 7.36  | x | 5.22  | x | 0.118 |
| 70 18 050              | FM7038MP        | STEEL      | HARD/BLACK        | 64              | EXT TH    | 196.4 | x | 140.0     | x | 2.9 | 7.73  | x | 5.51  | x | 0.114 |
| 70 19 278              | FM3006MP        | STEEL      | -----             | 70              | EXT TH    | 358.0 | x | 229.0     | x | 5.0 | 14.09 | x | 9.02  | x | 0.197 |
| 70 19 639              | FM4844MP        | STEEL      | -----             | 67              | (70)EX TH | 191.0 | x | 130.0     | x | 2.0 | 7.52  | x | 5.12  | x | 0.079 |
| 70 19 640              | FM3948MP        | STEEL      | -----             | 67              | (70)EX TH | 191.0 | x | 130.0     | x | 2.5 | 7.52  | x | 5.12  | x | 0.098 |
| 70 19 641              | FM3946MP        | STEEL      | -----             | 67              | (70)EX TH | 191.0 | x | 130.0     | x | 3.0 | 7.52  | x | 5.12  | x | 0.118 |
| 70 19 642              | FM3575          | PAPER      | 3 PASS            | 35              | INT TH    | 179.0 | x | 103.0     | x | 3.5 | 7.05  | x | 4.05  | x | 0.138 |
| 70 20 592              | FM4089          | PAPER      | 3 PASS            | 48              | INT TH    | 232.7 | x | 142.0     | x | 4.0 | 9.16  | x | 5.59  | x | 0.157 |
| 70 20 650              | FM4686MP        | STEEL      | -----             | 81              | EXT TH    | 243.6 | x | 152.1     | x | 2.5 | 9.59  | x | 5.99  | x | 0.098 |
| 70 20 651              | FM6896MP        | STEEL      | -----             | 81              | EXT TH    | 243.6 | x | 152.1     | x | 2.0 | 9.59  | x | 5.99  | x | 0.079 |
| 70 20 652              | FM6120-3.0      | STEEL      | -----             | 81              | EXT TH    | 243.5 | x | 153.0     | x | 3.0 | 9.59  | x | 6.02  | x | 0.118 |
| 70 20 814              | FM4451          | MOLYBDENUM | SPR/WAG           | 46              | (50)IN TH | 117.5 | x | 62.6      | x | 2.6 | 4.63  | x | 2.46  | x | 0.102 |
| 70 21 116              | FM2718MP        | STEEL      | -----             | 4               | EXT LG    | 129.0 | x | 76.0      | x | 1.5 | 5.08  | x | 2.99  | x | 0.059 |
| 70 21 117              | FM2719          | PAPER      | 2 PASS            | 33              | INT TH    | 117.9 | x | 68.1      | x | 2.2 | 4.64  | x | 2.68  | x | 0.087 |
| 70 21 171              | FM1324MP        | STEEL      | -----             | 54              | EXT TH    | 139.2 | x | 98.6      | x | 1.8 | 5.48  | x | 3.88  | x | 0.07  |
| 70 21 172              | FM1375OE        | BRONZE     | RADIAL            | 45              | INT TH    | 133.1 | x | 92.7      | x | 2.4 | 5.24  | x | 3.65  | x | 0.093 |
| 70 25 468              | FM4349          | PAPER      | WAFFLE            | 42              | INT TH    | 340.0 | x | 206.0     | x | 5.5 | 13.39 | x | 8.11  | x | 0.217 |
| 70 25 537              | FM2815          | PAPER      | 4 PASS            | 42              | INT TH    | 340.0 | x | 206.0     | x | 5.5 | 13.39 | x | 8.11  | x | 0.217 |
| 70 25 574              | FM2181          | BRONZE     | SPR/WAG           | 19              | INT TH    | 177.8 | x | 34.3      | x | 4.8 | 7.0   | x | 1.35  | x | 0.189 |
| 70 28 451              | FM3007          | PAPER      | 3 PASS            | 60              | INT TH    | 466.0 | x | 284.0     | x | 5.6 | 18.35 | x | 11.18 | x | 0.22  |
| 70 28 452              | FM3010MP        | STEEL      | -----             | 96              | EXT TH    | 488.0 | x | 310.0     | x | 6.0 | 19.21 | x | 12.2  | x | 0.236 |
| 70 28 641              | FM6130MP        | STEEL      | -----             | 3               | EXT LG    | 268.0 | x | 176.0     | x | 4.5 | 10.55 | x | 6.93  | x | 0.177 |
| 76 15 103              | FM3612MP        | STEEL      | -----             | 91              | EXT TH    | 355.0 | x | 217.0     | x | 5.0 | 13.98 | x | 8.54  | x | 0.197 |
| 76 15 184              | FM3024MP        | STEEL      | -----             | 12              | EXT LG    | 317.7 | x | 268.0     | x | 3.0 | 12.51 | x | 10.55 | x | 0.118 |
| 76 15 800              | FM2184MP        | STEEL      | -----             | 3               | EXT SL    | 201.7 | x | 129.5     | x | 2.7 | 7.94  | x | 5.1   | x | 0.106 |
| 76 17 718              | FM2890MP        | STEEL      | -----             | 3               | EXT LG    | 180.0 | x | 111.0     | x | 2.7 | 7.09  | x | 4.37  | x | 0.105 |
| 76 17 719              | FM2715          | PAPER      | 2 PASS            | 19              | INT TH    | 152.0 | x | 34.0      | x | 4.8 | 5.98  | x | 1.34  | x | 0.189 |
| 76 17 849              | FM3021          | BRONZE     | SUNBURST          | 87              | INT TH    | 306.0 | x | 258.0     | x | 3.0 | 12.05 | x | 10.16 | x | 0.118 |

| REPLACES<br>OEM PT.NO. | FMC<br>PART NO. | MATERIAL         | GROOVE<br>DETAILS | TEETH/<br>TANGS | SIZE MM   | SIZE INCH                                 |
|------------------------|-----------------|------------------|-------------------|-----------------|-----------|---|
| 76 18 237              | FM3608MP        | STEEL            | -----             | 88              | (91)EX TH | 293.0 x 185.0 x 4.5 11.54 x 7.28 x 0.177  |
| 76 18 492              | FM4625          | PAPER            | SUNBURST          | 16              | INT TH    | 201.0 x 40.5 x 4.9 7.91 x 1.59 x 0.192    |
| 76 18 493              | FM2344MP        | STEEL            | -----             | 6               | EXT LG    | 220.0 x 145.5 x 2.7 8.66 x 5.73 x 0.105   |
| 76 18 951              | FM2647          | PAPER            | 2 PASS            | 19              | INT TH    | 178.0 x 34.0 x 4.8 7.01 x 1.34 x 0.189    |
| 76 18 952              | FM2632MP        | STEEL            | -----             | 6               | EXT LG    | 199.0 x 130.0 x 2.6 7.83 x 5.12 x 0.102   |
| 76 18 958              | FM2811          | PAPER            | 4 PASS            | 34              | INT TH    | 277.0 x 167.0 x 4.5 10.91 x 6.57 x 0.177  |
| 76 18 977              | FM2815          | PAPER            | 4 PASS            | 42              | INT TH    | 340.0 x 206.0 x 5.5 13.39 x 8.11 x 0.217  |
| 76 19 323              | FM5407          | MOLYBDENUM       | RADIAL            | 34              | INT TH    | 109.8 x 66.0 x 1.3 4.32 x 2.6 x 0.052     |
| 76 19 324              | FM6922MP        | STEEL            | HARDENED          | 4               | EXT LG    | 122.6 x 72.2 x 1.8 4.83 x 2.84 x 0.071    |
| 76 19 325              | FM5409          | MOLYBDENUM/STEEL | RADIAL            | 34              | INT TH    | 109.8 x 66.0 x 2.9 4.32 x 2.6 x 0.112     |
| 76 19 478              | FM3608MP        | STEEL            | -----             | 88              | (91)EX TH | 293.0 x 185.0 x 4.5 11.54 x 7.28 x 0.177  |
| 76 19 479              | FM3606MP        | STEEL            | -----             | 88              | (91)EX TH | 293.0 x 185.0 x 4.0 11.54 x 7.28 x 0.157  |
| 76 19 839              | FM4766TW        | STEEL            | HARDENED          |                 | WASHER    | 46.0 x 26.2 x 1.0 1.81 x 1.03 x 0.039     |
| 76 20 194              | FM6641          | BRONZE           | SPR/RAD           | 34              | INT TH    | 196.0 x 170.0 x 2.2 7.72 x 6.69 x 0.087   |
| 76 21 789              | FM3612MP        | STEEL            | -----             | 91              | EXT TH    | 355.0 x 217.0 x 5.0 13.98 x 8.54 x 0.197  |
| 76 22 078              | FM5250-2.9      | STEEL            | HARDENED          | 4               | EXT LG    | 189.8 x 92.1 x 2.9 7.47 x 3.63 x 0.114    |
| 76 22 082              | FM5247          | MOLYBDENUM       | SPR/WAG           | 40              | INT TH    | 172.0 x 84.1 x 3.0 6.77 x 3.31 x 0.118    |
| 76 22 088              | FM3610MP        | STEEL            | -----             | 91              | EXT TH    | 355.0 x 217.0 x 4.5 13.98 x 8.54 x 0.177  |
| 76 22 089              | FM3614MP        | STEEL            | -----             | 91              | EXT TH    | 355.0 x 217.0 x 5.5 13.98 x 8.54 x 0.217  |
| 76 22 487              | FM4666MP        | STEEL            | HARDENED          | 6               | EXT SL    | 130.0 x 66.8 x 2.3 5.12 x 2.63 x 0.091    |
| 76 22 488              | FM4666-2.4      | STEEL            | HARDENED          | 6               | EXT SL    | 130.0 x 66.8 x 2.4 5.12 x 2.63 x 0.094    |
| 76 22 489              | FM4666-2.5      | STEEL            | HARDENED          | 6               | EXT SL    | 130.0 x 66.8 x 2.5 5.12 x 2.63 x 0.098    |
| 76 23 281              | FM2341          | BRONZE           | SUNBURST          | 16              | INT TH    | 202.9 x 40.4 x 4.9 7.99 x 1.59 x 0.192    |
| 76 23 461              | FM2344MP        | STEEL            | -----             | 6               | EXT LG    | 220.0 x 145.5 x 2.7 8.66 x 5.73 x 0.105   |
| 76 23 490              | FM2341          | BRONZE           | SUNBURST          | 16              | INT TH    | 202.9 x 40.4 x 4.9 7.99 x 1.59 x 0.192    |
| 76 23 491              | FM2344MP        | STEEL            | -----             | 6               | EXT LG    | 220.0 x 145.5 x 2.7 8.66 x 5.73 x 0.105   |
| 76 24 123              | FM7126-2.9      | STEEL            | HARDENED          | 4               | EXT LG    | 164.8 x 82.4 x 2.9 6.49 x 4.24 x 0.114    |
| 76 24 134              | FM4449          | MOLYBDENUM       | SPR/WAG           | 26              | INT TH    | 147.8 x 75.4 x 3.0 5.82 x 2.97 x 0.118    |
| 76 24 163              | FM4183          | PAPER            | WAF/WAG           | 64              | INT TH    | 345.0 x 252.1 x 4.7 13.58 x 9.93 x 0.185  |
| 76 24 164              | FM4186MP        | STEEL            | -----             | 20              | EXT LG    | 372.5 x 262.5 x 4.0 14.67 x 10.33 x 0.157 |
| 10029552               | FM4625          | PAPER            | SUNBURST          | 16              | INT TH    | 201.0 x 40.5 x 4.9 7.91 x 1.59 x 0.192    |
| 10029561               | FM4606MP        | STEEL            | -----             | 3               | EXT LG    | 216.9 x 144.0 x 2.7 8.54 x 5.67 x 0.106   |
| 10032805               | FM4183          | PAPER            | WAF/WAG           | 64              | INT TH    | 345.0 x 252.1 x 4.7 13.58 x 9.93 x 0.185  |
| 10032806               | FM5572MP        | STEEL            | -----             | 20              | EXT LG    | 372.5 x 262.5 x 2.0 14.67 x 10.33 x 0.079 |
| 10032844               | FM5250-3.0      | STEEL            | HARDENED          | 4               | EXT LG    | 189.8 x 92.1 x 3.0 7.47 x 3.63 x 0.118    |
| 10032845               | FM5250-2.9      | STEEL            | HARDENED          | 4               | EXT LG    | 189.8 x 92.1 x 2.9 7.47 x 3.63 x 0.114    |
| 10046873               | FM8153          | PAPER            | WAFFLE            | 27              | INT TH    | 81.5 x 53.0 x 1.6 3.21 x 2.09 x 0.063     |
| 10046889               | FM6977          | PAPER            | WAFFLE            | 54              | INT TH    | 178.0 x 105.6 x 3.8 7.01 x 4.16 x 0.148   |
| 10046890               | FM6980MP        | STEEL            | -----             | 4               | EXT LG    | 199.7 x 114.0 x 3.7 7.86 x 4.49 x 0.146   |
| 10100649               | FM3417          | BRONZE           | SPR/RAD           | 78              | EXT TH    | 236.0 x 155.0 x 4.0 9.29 x 6.1 x 0.157    |
| 10100650               | FM5004MP        | STEEL            | -----             | 46              | INT HT    | 225.0 x 132.0 x 2.5 8.86 x 5.2 x 0.098    |
| 10216943               | FM7255          | CARBON PA        | WAFFLE            | 36              | INT TH    | 305.0 x 56.5 x 5.4 12.01 x 2.22 x 0.211   |
| 10216944               | FM7258MP        | STEEL            | -----             | 8               | EXT LG    | 327.5 x 198.3 x 4.8 12.89 x 7.81 x 0.189  |
| 10219212               | FM8188MP        | STEEL            | HARDENED          | 45              | EXT TH    | 111.2 x 84.2 x 1.4 4.38 x 3.31 x 0.055    |
| 10330560               | FM4183          | PAPER            | WAF/WAG           | 64              | INT TH    | 345.0 x 252.1 x 4.7 13.58 x 9.93 x 0.185  |
| 10410834               | FM6130MP        | STEEL            | -----             | 3               | EXT LG    | 268.0 x 176.0 x 4.5 10.55 x 6.93 x 0.177  |
| 10410839               | FM6127          | PAPER            | WAFFLE            | 24              | INT TH    | 253.0 x 69.0 x 6.1 9.96 x 2.72 x 0.24     |

| REPLACES<br>OEM PT.NO.           | FMC<br>PART NO. | MATERIAL  | GROOVE<br>DETAILS | TEETH/<br>TANGS | SIZE MM   |       |   | SIZE INCH |   |     |       |   |       |   |       |
|----------------------------------|-----------------|-----------|-------------------|-----------------|-----------|-------|---|-----------|---|-----|-------|---|-------|---|-------|
| 10411155                         | FM4845-2.3      | BRONZE    | SPR/RAD           | 6               | EXT LG    | 157.0 | x | 102.0     | x | 2.3 | 6.18  | x | 4.02  | x | 0.091 |
| 10413413                         | FM7982MP        | STEEL     | SUNBURST          | 16              | EXT TH    | 176.2 | x | 103.5     | x | 3.9 | 6.94  | x | 4.07  | x | 0.155 |
| 10413414                         | FM7980MP        | STEEL     | SUNBURST          | 32              | (36)IN TH | 156.8 | x | 89.0      | x | 6.4 | 6.17  | x | 3.5   | x | 0.25  |
| 10423488                         | FM1782MP        | STEEL     | -----             | 9               | EXT LG    | 477.8 | x | 338.6     | x | 4.7 | 18.81 | x | 13.33 | x | 0.185 |
| 10423489                         | FM5159          | CARBON PA | 3 PASS            | 34              | (38)IN TH | 456.7 | x | 313.7     | x | 6.8 | 17.98 | x | 12.35 | x | 0.268 |
| 10492451                         | FM8172MP        | STEEL     | -----             | 24              | EXT LG    | 485.9 | x | 310.1     | x | 4.0 | 19.13 | x | 12.21 | x | 0.157 |
| 10663168                         | FM4625          | PAPER     | SUNBURST          | 16              | INT TH    | 201.0 | x | 40.5      | x | 4.9 | 7.91  | x | 1.59  | x | 0.192 |
| 11114932                         | FM4993          | PAPER     | 2 PASS            | 54              | EXT TH    | 139.0 | x | 99.0      | x | 2.7 | 5.47  | x | 3.9   | x | 0.104 |
| 11492097                         | FM6417          | BRONZE    | WAF/WAG           | 64              | INT TH    | 345.0 | x | 252.0     | x | 3.8 | 13.58 | x | 9.92  | x | 0.15  |
| 500499308                        | FM3982MP        | STEEL     | -----             | 24              | (32)EX TH | 306.0 | x | 237.0     | x | 2.0 | 12.03 | x | 9.3   | x | 0.079 |
| 501540414                        | FM2679          | BRONZE    | SPR/RAD           | 62              | EXT TH    | 188.0 | x | 132.0     | x | 2.4 | 7.4   | x | 5.2   | x | 0.094 |
| 501540514                        | FM5070MP        | STEEL     | -----             | 39              | INT TH    | 178.0 | x | 112.0     | x | 2.2 | 7.01  | x | 4.41  | x | 0.086 |
| 570272508                        | FM2279          | BRONZE    | SUNBURST          | 35              | EXT TH    | 177.5 | x | 109.0     | x | 2.0 | 6.99  | x | 4.29  | x | 0.079 |
| 570267608                        | FM3801          | PAPER     | RADIAL            | 30              | INT LG    | 329.0 | x | 285.0     | x | 3.0 | 12.96 | x | 11.24 | x | 0.117 |
| 571104408                        | FM4123          | BRONZE    | SUN-PLAIN         | 27              | EXT TH    | 137.4 | x | 90.9      | x | 1.6 | 5.41  | x | 3.58  | x | 0.063 |
| 571617908                        | FM4783          | CARBON PA | RADIAL            | 34              | EXT TH    | 177.4 | x | 111.5     | x | 2.5 | 6.98  | x | 4.39  | x | 0.098 |
| 571618008                        | FM4786MP        | STEEL     | -----             | 42              | INT TH    | 167.8 | x | 102.5     | x | 2.5 | 6.61  | x | 4.04  | x | 0.098 |
| 571622608                        | FM4787          | CARBON PA | RADIAL            | 44              | EXT TH    | 158.8 | x | 111.5     | x | 2.5 | 6.25  | x | 4.39  | x | 0.098 |
| 571622708                        | FM4790MP        | STEEL     | -----             | 42              | INT TH    | 150.9 | x | 102.5     | x | 2.5 | 5.94  | x | 4.04  | x | 0.098 |
| 571665308                        | FM6781          | CARBON PA | RADIAL            | 64              | EXT TH    | 196.0 | x | 142.0     | x | 2.6 | 7.72  | x | 5.59  | x | 0.1   |
| 571665408                        | FM6783          | CARBON PA | RADIAL/PLAIN      | 64              | EXT TH    | 196.0 | x | 142.0     | x | 2.0 | 7.72  | x | 5.59  | x | 0.079 |
| 571665808                        | FM8597          | CARBON PA | RADIAL/PLAIN      | 35              | EXT TH    | 176.5 | x | 142.0     | x | 1.9 | 6.95  | x | 5.51  | x | 0.073 |
| ?                                | FM4411          | BRONZE    | SPR/RAD/WAG       | 35              | INT TH    | 140.0 | x | 102.5     | x | 2.1 | 5.51  | x | 4.04  | x | 0.083 |
| ?                                | FM4414MP        | STEEL     | SPIRAL            | 36              | EXT TH    | 150.1 | x | 109.2     | x | 1.5 | 5.91  | x | 4.3   | x | 0.059 |
| <b>LIMB</b>                      |                 |           |                   |                 |           |       |   |           |   |     |       |   |       |   |       |
| 3A20636                          | FM3474MP        | STEEL     | -----             | 4               | EXT LG    | 85.0  | x | 49.2      | x | 1.5 | 3.35  | x | 1.94  | x | 0.059 |
| <b>LINDE</b>                     |                 |           |                   |                 |           |       |   |           |   |     |       |   |       |   |       |
| T033002170                       | FM2710MP        | STEEL     | -----             | 52              | INT TH    | 177.8 | x | 128.2     | x | 2.3 | 7.0   | x | 5.05  | x | 0.091 |
| T068002013                       | FM2707          | BRONZE    | WAFFLE            | 88              | EXT TH    | 189.4 | x | 141.7     | x | 3.1 | 7.46  | x | 5.58  | x | 0.122 |
| 1275040101                       | FM4817          | GRAPH/STL | SUN/PLAIN         | 36              | (73)EX TH | 151.5 | x | 101.5     | x | 2.8 | 5.96  | x | 4.0   | x | 0.108 |
| 1275043001                       | FM2969          | BRONZE    | WAFFLE            | 22              | INT TH    | 71.7  | x | 44.0      | x | 1.6 | 2.82  | x | 1.73  | x | 0.063 |
| 3563320600                       | FM3007          | PAPER     | 3 PASS            | 60              | INT TH    | 466.0 | x | 284.0     | x | 5.6 | 18.35 | x | 11.18 | x | 0.22  |
| 3573240700                       | FM6435          | CARBON PA | WAFFLE            | 52              | INT TH    | 193.0 | x | 107.5     | x | 2.6 | 7.6   | x | 4.23  | x | 0.102 |
| 3573240701                       | FM6018MP        | STEEL     | -----             | 78              | EXT TH    | 200.0 | x | 114.0     | x | 3.0 | 7.87  | x | 4.49  | x | 0.118 |
| 3573240702                       | FM5376MP        | STEEL     | -----             | 45              | INT TH    | 148.3 | x | 92.7      | x | 2.3 | 5.84  | x | 33.65 | x | 0.089 |
| 3573240703                       | FM6437          | CARBON PA | WAFFLE            | 60              | EXT TH    | 154.0 | x | 99.0      | x | 2.7 | 6.06  | x | 3.9   | x | 0.104 |
| 3573240704                       | FM6439          | CARBON PA | WAFFLE/PLAIN      | 60              | EXT TH    | 154.0 | x | 99.0      | x | 1.9 | 6.06  | x | 3.9   | x | 0.075 |
| 3573240705                       | FM6016MP        | STEEL     | -----             | 78              | EXT TH    | 200.0 | x | 114.0     | x | 2.3 | 7.87  | x | 4.49  | x | 0.089 |
| 5075041301                       | FM4231          | PAPER     | 2 PASS            | 24              | INT TH    | 114.0 | x | 46.0      | x | 2.2 | 4.49  | x | 1.81  | x | 0.087 |
| ?                                | FM8925          | PAPER     | 2 PASS            | 44              | INT TH    | 162.0 | x | 105.8     | x | 2.1 | 6.38  | x | 4.17  | x | 0.083 |
| ?                                | FM9399          | PAPER     | 2 PASS            | 51              | INT TH    | 134.8 | x | 95.0      | x | 2.1 | 5.31  | x | 3.74  | x | 0.087 |
| <b>LINK BELT SPEEDER SHOVELS</b> |                 |           |                   |                 |           |       |   |           |   |     |       |   |       |   |       |
| 3A-4859                          | OBSOLETE        | GRAPHITE  | SUNBURST          | 36              | INT TH    | 177.8 | x | 111.0     | x | 3.2 | 7.0   | x | 4.37  | x | 0.126 |

| REPLACES<br>OEM PT.NO. | FMC<br>PART NO. | MATERIAL | GROOVE<br>DETAILS | TEETH/<br>TANGS | SIZE MM   |       |   |       | SIZE INCH |      |       |   |      |   |       |
|------------------------|-----------------|----------|-------------------|-----------------|-----------|-------|---|-------|-----------|------|-------|---|------|---|-------|
| <b>LIUGONG</b>         |                 |          |                   |                 |           |       |   |       |           |      |       |   |      |   |       |
| ?                      | FM6779          | BRONZE   | SPR/RAD           | 50              | INT TH    | 198.1 | x | 122.8 | x         | 3.0  | 7.8   | x | 4.83 | x | 0.118 |
| ?                      | FM6782MP        | STEEL    | -----             | 73              | EXT TH    | 221.7 | x | 130.1 | x         | 2.0  | 8.73  | x | 5.12 | x | 0.079 |
| ?                      | FM7965          | BRONZE   | SPR/RAD           | 40              | INT TH    | 168.0 | x | 97.5  | x         | 2.5  | 6.61  | x | 3.84 | x | 0.098 |
| ?                      | FM7968MP        | STEEL    | -----             | 73              | EXT TH    | 185.0 | x | 105.0 | x         | 1.5  | 7.28  | x | 4.13 | x | 0.059 |
| MIR-55C.40B.013        | FM6973          | BRONZE   | SUNBURST          | 43              | INT TH    | 146.0 | x | 105.2 | x         | 2.6  | 5.75  | x | 4.14 | x | 0.102 |
| MIR-55C.40B.014        | FM7306MP        | STEEL    | -----             | 56              | (60)IN TH | 152.5 | x | 113.0 | x         | 1.7  | 6.0   | x | 4.45 | x | 0.067 |
| SP100007               | FM2279          | BRONZE   | SUNBURST          | 35              | EXT TH    | 177.5 | x | 109.0 | x         | 2.0  | 6.99  | x | 4.29 | x | 0.079 |
| SP100461               | FM3602MP        | STEEL    | -----             | 35              | INT TH    | 170.9 | x | 102.9 | x         | 2.0  | 6.73  | x | 4.05 | x | 0.079 |
| SP110783               | FM6088MP        | STEEL    | -----             | 35              | INT TH    | 170.9 | x | 102.9 | x         | 3.0  | 6.73  | x | 4.05 | x | 0.118 |
| <b>LONGKING</b>        |                 |          |                   |                 |           |       |   |       |           |      |       |   |      |   |       |
| ZL30E.5.1-12           | FM6973          | BRONZE   | SUNBURST          | 43              | INT TH    | 146.0 | x | 105.2 | x         | 2.6  | 5.75  | x | 4.14 | x | 0.102 |
| ZL30E.5.1-13           | FM7306MP        | STEEL    | -----             | 56              | (60)IN TH | 152.5 | x | 113.0 | x         | 1.7  | 6.0   | x | 4.45 | x | 0.067 |
| <b>LUNDBERG HYMAS</b>  |                 |          |                   |                 |           |       |   |       |           |      |       |   |      |   |       |
| 8300952                | FM4015          | GRAPHITE | SUNBURST          | 27              | INT TH    | 303.8 | x | 66.1  | x         | 10.0 | 11.96 | x | 2.6  | x | 0.393 |



| REPLACES<br>OEM PT.NO.         | FMC<br>PART NO. | MATERIAL  | GROOVE<br>DETAILS | TEETH/<br>TANGS | SIZE MM   |       |   | SIZE INCH |   |     |       |   |       |   |       |
|--------------------------------|-----------------|-----------|-------------------|-----------------|-----------|-------|---|-----------|---|-----|-------|---|-------|---|-------|
| <b>MACK TRUCK</b>              |                 |           |                   |                 |           |       |   |           |   |     |       |   |       |   |       |
| 62SC-2551.18                   | FM3011          | PAPER     | 2 PASS            | 53              | INT TH    | 342.9 | x | 220.5     | x | 5.2 | 13.5  | x | 8.68  | x | 0.204 |
| 62SC-2551.18                   | OBSOLETE        | PAPER     | 2 PASS            | 53              | INT TH    | 342.9 | x | 220.5     | x | 5.4 | 13.5  | x | 8.68  | x | 0.212 |
| 62SC-26                        | FM3014MP        | STEEL     | -----             | 83              | EXT TH    | 355.0 | x | 238.4     | x | 6.3 | 13.98 | x | 9.38  | x | 0.247 |
| 6770590                        | FM2667          | BRONZE    | SPIRAL            | 100             | INT TH    | 409.4 | x | 314.2     | x | 4.5 | 16.12 | x | 12.37 | x | 0.178 |
| 308SH79                        | FM1311          | GRAPHITE  | SUNBURST          | 73              | INT TH    | 371.3 | x | 303.0     | x | 5.2 | 14.62 | x | 11.93 | x | 0.205 |
| 308SH82                        | FM3347          | BRONZE    | SUNBURST          | 72              | INT TH    | 246.1 | x | 178.1     | x | 4.9 | 9.69  | x | 7.01  | x | 0.193 |
| 308SH87                        | FM5827          | BRONZE    | SUNBURST          | 52              | INT TH    | 292.1 | x | 213.9     | x | 5.1 | 11.5  | x | 8.42  | x | 0.201 |
| 308SH108                       | FM1177          | GRAPHITE  | SUNBURST          | 72              | INT TH    | 371.3 | x | 303.0     | x | 5.2 | 14.62 | x | 11.93 | x | 0.205 |
| 308SH133                       | FM1177          | GRAPHITE  | SUNBURST          | 72              | INT TH    | 371.3 | x | 303.0     | x | 5.2 | 14.62 | x | 11.93 | x | 0.205 |
| 308SH135                       | FM1177          | GRAPHITE  | SUNBURST          | 72              | INT TH    | 371.3 | x | 303.0     | x | 5.2 | 14.62 | x | 11.93 | x | 0.205 |
| <b>MAFI</b>                    |                 |           |                   |                 |           |       |   |           |   |     |       |   |       |   |       |
| 000.602.5095                   | FM4817          | GRAPH/STL | SUN/PLAIN         | 36              | (73)EX TH | 151.5 | x | 101.5     | x | 2.8 | 5.96  | x | 4.0   | x | 0.108 |
| 000.602.5102                   | FM2969          | BRONZE    | WAFFLE            | 22              | INT TH    | 71.7  | x | 44.0      | x | 1.6 | 2.82  | x | 1.73  | x | 0.063 |
| 000.902.0421                   | FM3592MP        | STEEL     | -----             | 29              | INT TH    | 131.1 | x | 85.1      | x | 1.5 | 5.16  | x | 3.35  | x | 0.059 |
| 000.902.0422                   | FM3596MP        | STEEL     | -----             | 29              | INT TH    | 131.1 | x | 85.1      | x | 2.5 | 5.16  | x | 3.35  | x | 0.098 |
| 000.902.0423                   | FM3594MP        | STEEL     | -----             | 29              | INT TH    | 131.1 | x | 85.1      | x | 2.0 | 5.16  | x | 3.35  | x | 0.079 |
| 000.902.0426                   | FM3602MP        | STEEL     | -----             | 35              | INT TH    | 170.9 | x | 102.9     | x | 2.0 | 6.73  | x | 4.05  | x | 0.079 |
| 000.902.0427                   | FM3604MP        | STEEL     | -----             | 35              | INT TH    | 170.9 | x | 102.9     | x | 2.5 | 6.73  | x | 4.05  | x | 0.098 |
| <b>MAHINDRA &amp; MAHINDRA</b> |                 |           |                   |                 |           |       |   |           |   |     |       |   |       |   |       |
| 006500423C1                    | FM2971          | BRONZE    | WAFFLE            | 22              | INT TH    | 71.7  | x | 44.0      | x | 2.8 | 2.82  | x | 1.73  | x | 0.11  |
| 006500424C1                    | FM3474MP        | STEEL     | -----             | 4               | EXT LG    | 85.0  | x | 49.2      | x | 1.5 | 3.35  | x | 1.94  | x | 0.059 |
| 006500425C1                    | FM2969          | BRONZE    | WAFFLE            | 22              | INT TH    | 71.7  | x | 44.0      | x | 1.6 | 2.82  | x | 1.73  | x | 0.063 |
| <b>MAN</b>                     |                 |           |                   |                 |           |       |   |           |   |     |       |   |       |   |       |
| 81332140070                    | FM9351          | CARBON PA | 2 PASS            | 34              | INT TH    | 146.7 | x | 99.7      | x | 2.1 | 5.78  | x | 3.93  | x | 0.083 |
| 81332140071                    | FM9354MP        | STEEL     | -----             | 8               | EXT LG    | 161.6 | x | 107.0     | x | 1.8 | 6.36  | x | 4.21  | x | 0.071 |
| <b>MANITOU</b>                 |                 |           |                   |                 |           |       |   |           |   |     |       |   |       |   |       |
| 106375                         | FM1276MP        | STEEL     | DISHED            | 50              | (54)EX TH | 139.2 | x | 98.6      | x | 1.8 | 5.48  | x | 3.88  | x | 0.07  |
| 106376                         | FM3819          | BRONZE    | SPIRAL            | 45              | INT TH    | 133.1 | x | 92.7      | x | 2.4 | 5.24  | x | 3.65  | x | 0.096 |
| 106603                         | FM2181          | BRONZE    | SPR/WAG           | 19              | INT TH    | 177.8 | x | 34.3      | x | 4.8 | 7.0   | x | 1.35  | x | 0.189 |
| 106604                         | FM2184MP        | STEEL     | -----             | 3               | EXT SL    | 201.7 | x | 129.5     | x | 2.7 | 7.94  | x | 5.1   | x | 0.105 |
| 109594                         | FM1324MP        | STEEL     | -----             | 54              | EXT TH    | 139.2 | x | 98.6      | x | 1.8 | 5.48  | x | 3.88  | x | 0.07  |
| 109604                         | FM1649          | PAPER     | 2 PASS            | 45              | INT TH    | 133.1 | x | 92.7      | x | 1.6 | 5.24  | x | 3.65  | x | 0.063 |
| 109604                         | FM1359          | BRONZE    | SPIRAL            | 45              | INT TH    | 133.1 | x | 92.7      | x | 1.6 | 5.24  | x | 3.65  | x | 0.063 |
| 128947                         | FM6420MP        | STEEL     | -----             | 22              | INT TH    | 155.6 | x | 79.4      | x | 2.0 | 6.13  | x | 3.13  | x | 0.079 |
| 129068                         | FM3499          | BRONZE    | SPR/RAD           | 12              | EXT SL    | 181.5 | x | 120.3     | x | 2.5 | 7.15  | x | 4.74  | x | 0.098 |
| 129074                         | FM4900MP        | STEEL     | HARDENED          | 20              | INT TH    | 155.0 | x | 73.7      | x | 2.0 | 6.1   | x | 2.9   | x | 0.079 |
| 133987                         | FM1705          | BRONZE    | SPR/WAG           | 22              | INT TH    | 204.5 | x | 53.3      | x | 4.8 | 8.05  | x | 2.1   | x | 0.19  |
| 133989                         | FM1202MP        | STEEL     | -----             | 1               | EXT LG    | 209.3 | x | 114.3     | x | 2.7 | 8.24  | x | 4.5   | x | 0.106 |
| 136083                         | FM1359          | BRONZE    | SPIRAL            | 45              | INT TH    | 133.1 | x | 92.7      | x | 1.6 | 5.24  | x | 3.65  | x | 0.063 |
| 136103                         | FM1276MP        | STEEL     | DISHED            | 50              | (54)EX TH | 138.9 | x | 98.0      | x | 1.8 | 5.47  | x | 3.86  | x | 0.07  |
| 209373                         | FM3382FP        | STEEL     | FLEXI PLATE       | 6               | HOLE      | 339.7 | x | 133.4     | x | 1.5 | 13.37 | x | 5.25  | x | 0.059 |
| 209374                         | FM4442FP        | STEEL     | REINF PLATE       | 6               | HOLE      | 186.5 | x | 132.0     | x | 2.1 | 7.34  | x | 5.2   | x | 0.83  |
| 209574                         | FM3382KIT       | STEEL     | FLEXI PLATE       |                 |           |       |   |           |   |     |       |   |       |   |       |

| REPLACES<br>OEM PT.NO. | FMC<br>PART NO. | MATERIAL   | GROOVE<br>DETAILS | TEETH/<br>TANGS | SIZE MM    | SIZE INCH                                |
|------------------------|-----------------|------------|-------------------|-----------------|------------|--|
| 449273                 | FM1324MP        | STEEL      | -----             | 54              | EXT TH     | 139.2 x 98.6 x 1.8 5.48 x 3.88 x 0.07    |
| 449301                 | FM1375OE        | BRONZE     | RADIAL            | 45              | INT TH     | 133.1 x 92.7 x 2.4 5.24 x 3.65 x 0.093   |
| 449375                 | FM2718MP        | STEEL      | -----             | 4               | EXT LG     | 129.0 x 76.0 x 1.5 5.08 x 2.99 x 0.059   |
| 449376                 | FM2719          | PAPER      | 2 PASS            | 33              | INT TH     | 117.9 x 68.1 x 2.2 4.64 x 2.68 x 0.087   |
| 449384                 | FM4036MP        | END PLATE  | STEPPED           | 4               | EXT LG     | 129.0 x 74.0 x 5.0 5.08 x 2.91 x 0.197   |
| 449461                 | FM1337OE        | BRONZE     | RADIAL            | 45              | INT TH     | 133.1 x 92.7 x 2.3 5.24 x 3.65 x 0.09    |
| 473725                 | FM2629          | BRONZE     | 2 x RAD           | 45              | INT TH     | 133.1 x 92.7 x 2.0 5.24 x 3.65 x 0.079   |
| 473832                 | FM2781          | GRAPHITE   | SUNBURST          | 15              | INT TH     | 213.0 x 44.0 x 10.0 8.38 x 1.73 x 0.394  |
| 475312                 | FM2971          | BRONZE     | WAFFLE            | 22              | INT TH     | 71.7 x 44.0 x 2.8 2.82 x 1.73 x 0.11     |
| 475313                 | FM3474MP        | STEEL      | -----             | 4               | EXT LG     | 85.0 x 49.2 x 1.5 3.35 x 1.94 x 0.059    |
| 475314                 | FM2969          | BRONZE     | WAFFLE            | 22              | INT TH     | 71.7 x 44.0 x 1.6 2.82 x 1.73 x 0.063    |
| 475796                 | FM2647          | PAPER      | 2 PASS            | 19              | INT TH     | 178.0 x 34.0 x 4.8 7.01 x 1.34 x 0.189   |
| 477279                 | FM2184MP        | STEEL      | -----             | 3               | EXT SL     | 201.7 x 129.5 x 2.7 7.94 x 5.1 x 0.106   |
| 477709                 | FM2632MP        | STEEL      | -----             | 6               | EXT LG     | 199.0 x 130.0 x 2.6 7.83 x 5.12 x 0.102  |
| 478128                 | FM2783          | GRAPHITE   | SUNBURST          | 19              | INT TH     | 143.0 x 34.0 x 4.8 5.63 x 1.34 x 0.189   |
| 501266                 | FM4742MP        | STEEL      | -----             | 1               | EXT SL     | 149.0 x 80.0 x 2.7 5.87 x 3.15 x 0.105   |
| 508331                 | FM3419          | BRONZE     | WAFFLE            | 32              | INT TH     | 90.0 x 64.3 x 1.6 3.54 x 2.53 x 0.063    |
| 508332                 | FM4912MP        | STEEL      | -----             | 36              | EXT TH     | 93.3 x 71.8 x 1.0 3.67 x 2.8 x 0.039     |
| 508333                 | FM6038MP        | STEEL      | -----             | 36              | EXT TH     | 93.3 x 71.8 x 3.0 3.67 x 2.83 x 0.118    |
| 547511                 | FM3261          | PAPER      | 2 PASS            | 40              | INT TH     | 127.1 x 82.2 x 2.5 5.0 x 3.24 x 0.098    |
| 549313                 | FM3824MP        | STEEL      | -----             | 2               | EXT LG     | 195.0 x 110.0 x 2.6 7.68 x 4.33 x 0.102  |
| 549314                 | FM3103          | GRAPHITE   | WAFFLE            | 28              | INT TH     | 169.0 x 56.0 x 4.8 6.65 x 2.21 x 0.189   |
| 551717                 | FM2181          | BRONZE     | SUNBURST          | 19              | INT TH     | 177.8 x 34.2 x 4.8 7.0 x 1.35 x 0.189    |
| 561797                 | FM3264MP        | STEEL      | -----             | 26              | EXT TH     | 143.5 x 89.5 x 2.2 5.65 x 3.52 x 0.084   |
| 561798                 | FM3261          | PAPER      | 2 PASS            | 40              | INT TH     | 127.1 x 82.2 x 2.5 5.0 x 3.24 x 0.98     |
| 562259                 | FM2341          | BRONZE     | SUNBURST          | 16              | INT TH     | 202.9 x 40.4 x 4.9 7.99 x 1.59 x 0.192   |
| 562516                 | FM4625          | PAPER      | SUNBURST          | 16              | INT TH     | 201.0 x 40.5 x 4.9 7.91 x 1.59 x 0.192   |
| 562525                 | FM4606MP        | STEEL      | -----             | 3               | EXT LG     | 216.9 x 144.0 x 2.7 8.54 x 5.67 x 0.106  |
| 564439                 | FM1324MP        | STEEL      | -----             | 54              | EXT TH     | 139.2 x 98.6 x 1.8 5.48 x 3.88 x 0.07    |
| 564440                 | FM2829          | PAPER      | 2 PASS            | 45              | INT TH     | 133.1 x 92.7 x 2.1 5.24 x 3.65 x 0.083   |
| 582476                 | FM6823          | BRONZE     | WAFFLE            | 24              | (27) IN TH | 88.0 x 53.2 x 1.6 3.46 x 2.09 x 0.063    |
| 600482                 | FM2823          | PAPER      | 2 PASS            | 36              | INT TH     | 223.0 x 71.0 x 4.9 8.78 x 2.8 x 0.191    |
| 600483                 | FM3912MP        | END PLATE  | -----             | 64              | EXT TH     | 230.0 x 152.5 x 5.0 9.06 x 6.0 x 0.197   |
| 602074                 | FM7337          | PAPER      | 2 PASS            | 36              | INT TH     | 223.0 x 71.0 x 4.9 8.78 x 2.8 x 0.191    |
| 602438                 | FM3414MP        | END PLATE  | -----             | 32              | (64)EX TH  | 230.0 x 152.5 x 10.8 9.06 x 6.0 x 0.397  |
| 656123                 | FM5459          | GRAPHITE   | SUNBURST          | 25              | INT TH     | 223.5 x 62.0 x 5.7 8.8 x 2.44 x 0.224    |
| 703134                 | FM6977          | PAPER      | WAFFLE            | 54              | INT TH     | 178.0 x 105.6 x 3.8 7.01 x 4.16 x 0.148  |
| 703135                 | FM6980MP        | STEEL      | -----             | 4               | EXT LG     | 199.7 x 114.0 x 3.7 7.86 x 4.49 x 0.146  |
| 717529                 | FM6130MP        | STEEL      | -----             | 3               | EXT LG     | 268.0 x 176.0 x 4.5 10.55 x 6.93 x 0.177 |
| 737216                 | FM6125          | PAPER      | WAFFLE            | 28              | (32)IN TH  | 253.0 x 160.0 x 6.1 9.96 x 6.3 x 0.24    |
| 737219                 | FM6127          | PAPER      | WAFFLE            | 24              | INT TH     | 253.0 x 69.0 x 6.1 9.96 x 2.72 x 0.24    |
| 786594                 | FM4625          | PAPER      | SUNBURST          | 16              | INT TH     | 201.0 x 40.5 x 4.9 7.91 x 1.59 x 0.192   |
| 894790                 | FM8599          | CARBON PA  | SUNBURST          | 16              | INT TH     | 201.0 x 40.5 x 4.9 7.91 x 1.59 x 0.192   |
| 53017592               | FM4606MP        | STEEL      | -----             | 3               | EXT LG     | 216.9 x 144.0 x 2.7 8.54 x 5.67 x 0.106  |
| A4102837A              | FM3948MP        | STEEL      | -----             | 67              | (70)EX TH  | 191.0 x 130.0 x 2.5 7.52 x 5.12 x 0.098  |
| A4102839A              | FM3575          | PAPER      | 3 PASS            | 35              | INT TH     | 179.0 x 103.0 x 3.5 7.05 x 4.05 x 0.138  |
| A4108242A              | FM4089          | PAPER      | 3 PASS            | 48              | INT TH     | 232.7 x 142.0 x 4.0 9.16 x 5.59 x 0.157  |
| A4199742A              | FM4449          | MOLYBDENUM | SPR/WAG           | 26              | INT TH     | 147.8 x 75.4 x 3.0 5.82 x 2.97 x 0.118   |

| REPLACES OEM PT.NO. | FMC PART NO. | MATERIAL | GROOVE DETAILS | TEETH/TANGS | SIZE MM | SIZE INCH |
|---------------------|--------------|----------|----------------|-------------|---------|-----------|
|---------------------|--------------|----------|----------------|-------------|---------|-----------|

### MARATHON LE TOURNEAU

|         |          |          |       |    |        |                     |                     |
|---------|----------|----------|-------|----|--------|---------------------|---------------------|
| 4015420 | FM1286MP | OBSOLETE | ----- | 54 | INT TH | 330.2 x 224.0 x 4.6 | 13.0 x 8.82 x 0.18  |
| 4015420 | OBSOLETE | STEEL    | ----- | 54 | INT TH | 327.0 x 222.3 x 9.4 | 12.88 x 8.75 x 0.37 |
| 4039598 | FM1681   | OBSOLETE | ----- | 81 | EXT TH | 327.7 x 238.3 x 6.0 | 12.9 x 9.38 x 0.235 |

### MASSEY FERGUSON

|           |             |           |            |     |           |                     |                       |
|-----------|-------------|-----------|------------|-----|-----------|---------------------|-----------------------|
| 1089578   | FM1417      | CARBON PA | SUNBURST   | 57  | INT TH    | 303.8 x 235.2 x 3.9 | 11.96 x 9.26 x 0.153  |
| 185062M3  | FM1389      | BRONZE    | SPIRAL     | 57  | INT TH    | 128.3 x 87.9 x 2.5  | 5.05 x 3.46 x 0.098   |
| 185464M1  | FM1798MP    | STEEL     | -----      | 6   | (33)EX TH | 144.0 x 94.5 x 1.7  | 5.67 x 3.72 x 0.066   |
| 190177M1  | FM1389      | BRONZE    | SPIRAL     | 57  | INT TH    | 128.3 x 87.9 x 2.5  | 5.05 x 3.46 x 0.098   |
| 513242M1  | FM1544MP    | STEEL     | -----      | 33  | EXT TH    | 144.0 x 94.5 x 1.4  | 5.67 x 3.72 x 0.055   |
| 514276M1  | FM1389      | BRONZE    | SPIRAL     | 57  | INT TH    | 128.3 x 87.9 x 2.5  | 5.05 x 3.46 x 0.098   |
| 521282M1  | FM1389      | BRONZE    | SPIRAL     | 57  | INT TH    | 128.3 x 87.9 x 2.5  | 5.05 x 3.46 x 0.098   |
| 533326M2  | FM1389      | BRONZE    | SPIRAL     | 57  | INT TH    | 128.3 x 87.9 x 2.5  | 5.05 x 3.46 x 0.098   |
| 975743M1  | FM5862MP    | STEEL     | HARD/BLACK | 21  | INT TH    | 229.0 x 171.0 x 2.0 | 9.01 x 6.73 x 0.078   |
| 975744M1  | FM5055      | BRONZE    | -----      | 28  | EXT TH    | 239.0 x 180.1 x 4.0 | 9.41 x 7.09 x 0.157   |
| 980130M1  | FM1601      | BRONZE    | -----      | 95  | EXT TH    | 305.6 x 212.6 x 4.7 | 12.03 x 8.37 x 0.187  |
| 980131M1  | FM1882MP    | STEEL     | -----      | 63  | INT TH    | 289.1 x 193.8 x 2.3 | 11.38 x 7.63 x 0.09   |
| 1420482M1 | FM4336MP    | STEEL     | -----      | 28  | INT TH    | 127.0 x 79.0 x 1.8  | 5 x 3.11 x 0.071      |
| 1420484M1 | FM2865      | BRONZE    | SUNBURST   | 64  | EXT TH    | 138.8 x 95.2 x 2.8  | 5.46 x 3.75 x 0.11    |
| 1423483M1 | FM5055      | BRONZE    | -----      | 28  | EXT TH    | 239.0 x 180.1 x 4.0 | 9.41 x 7.09 x 0.157   |
| 1430064M1 | FM5123      | BRONZE    | WAFFLE     | 88  | EXT TH    | 189.5 x 117.6 x 3.1 | 7.46 x 4.63 x 0.122   |
| 1611165M1 | FM5536MP    | STEEL     | -----      | 54  | (81)EX TH | 174.8 x 137.0 x 1.5 | 6.88 x 5.39 x 0.059   |
| 1611284M1 | FM5538MP    | STEEL     | -----      | 81  | EXT TH    | 174.5 x 138.0 x 1.9 | 6.87 x 5.43 x 0.073   |
| 1618239M4 | FM5223      | BRONZE    | SPR/RAD    | 23  | INT TH    | 152.0 x 70.0 x 3.0  | 5.98 x 2.76 x 0.118   |
| 1669474M1 | FM1707      | BRONZE    | SPR/WAG    | 27  | INT TH    | 224.0 x 55.1 x 4.8  | 8.82 x 2.17 x 0.19    |
| 1669475M1 | FM1707      | BRONZE    | SPR/WAG    | 27  | INT TH    | 224.0 x 55.1 x 4.8  | 8.82 x 2.17 x 0.19    |
| 1672626M1 | FM1389      | BRONZE    | SPIRAL     | 57  | INT TH    | 128.3 x 87.9 x 2.5  | 5.05 x 3.46 x 0.098   |
| 1686359M1 | FM3717      | BRONZE    | SUNBURST   | 57  | INT TH    | 128.3 x 87.8 x 2.5  | 5.05 x 3.46 x 0.98    |
| 1688532M1 | FM5767      | BRONZE    | WAFFLE     | 57  | INT TH    | 128.5 x 87.9 x 1.5  | 5.06 x 3.46 x 0.059   |
| 1692155M1 | FM3486-0.5  | STEEL     | -----      | 27  | (33)EX TH | 144.2 x 94.4 x 0.5  | 5.68 x 3.72 x 0.02    |
| 1692156M1 | FM3486-0.75 | STEEL     | -----      | 27  | (33)EX TH | 144.2 x 94.4 x 0.8  | 5.68 x 3.72 x 0.03    |
| 1692157M1 | FM3486MP    | STEEL     | -----      | 27  | (33)EX TH | 144.2 x 94.4 x 1.4  | 5.68 x 3.72 x 0.055   |
| 1754344M1 | FM1276MP    | STEEL     | DISHED     | 50  | (54)EX TH | 138.9 x 98.0 x 1.8  | 5.47 x 3.86 x 0.07    |
| 1754345M1 | FM1359      | BRONZE    | SPIRAL     | 45  | INT TH    | 133.1 x 92.7 x 1.6  | 5.24 x 3.65 x 0.063   |
| 1804831M1 | FM1359      | BRONZE    | SPIRAL     | 45  | INT TH    | 133.1 x 92.7 x 1.6  | 5.24 x 3.65 x 0.063   |
| 1816240M1 | FM1617      | BRONZE    | SPR/WAG    | 95  | EXT TH    | 304.8 x 212.9 x 4.3 | 12.0 x 8.38 x 0.168   |
| 1860532M9 | FM0623      | OBSOLETE  | -----      |     | FACING    | 301.5 x 190.5 x 4.1 | 11.87 x 7.5 x 0.16    |
| 1860964M2 | FM1707      | BRONZE    | SPR/WAG    | 27  | INT TH    | 224.0 x 55.1 x 4.8  | 8.82 x 2.17 x 0.19    |
| 1860965M2 | FM1204MP    | STEEL     | -----      | 1   | EXT LG    | 228.6 x 127.0 x 2.7 | 9.0 x 5.0 x 0.106     |
| 1862289M2 | FM1389      | BRONZE    | SPIRAL     | 57  | INT TH    | 128.3 x 87.9 x 2.5  | 5.05 x 3.46 x 0.098   |
| 1867388M1 | FM1544MP    | STEEL     | -----      | 33  | EXT TH    | 144.0 x 94.5 x 1.4  | 5.67 x 3.72 x 0.055   |
| 1870074M1 | FM1389      | BRONZE    | SPIRAL     | 57  | INT TH    | 128.3 x 87.9 x 2.5  | 5.05 x 3.46 x 0.098   |
| 1870860M1 | FM1544MP    | STEEL     | -----      | 33  | EXT TH    | 144.0 x 94.5 x 1.4  | 5.67 x 3.72 x 0.055   |
| 1870879M1 | FM1389      | BRONZE    | SPIRAL     | 57  | INT TH    | 128.3 x 87.9 x 2.5  | 5.05 x 3.46 x 0.098   |
| 2527328M1 | FM1359      | BRONZE    | SPIRAL     | 45  | INT TH    | 133.1 x 92.7 x 1.6  | 5.24 x 3.65 x 0.063   |
| 2707456M1 | FM1644MP    | STEEL     | -----      | 88  | INT TH    | 365.8 x 273.1 x 2.3 | 14.4 x 10.75 x 0.09   |
| 2707457M1 | FM1613      | BRONZE    | SPR/WAG    | 120 | EXT TH    | 384.0 x 291.3 x 4.7 | 15.12 x 11.47 x 0.185 |

| REPLACES<br>OEM PT.NO. | FMC<br>PART NO. | MATERIAL | GROOVE<br>DETAILS | TEETH/<br>TANGS | SIZE MM   | SIZE INCH                                 |
|------------------------|-----------------|----------|-------------------|-----------------|-----------|---|
| 2718768M1              | FM1603          | BRONZE   | -----             | 120             | EXT TH    | 384.8 x 292.6 x 4.7 15.15 x 11.52 x 0.187 |
| 2737543M1              | OBSOLETE        | BRONZE   | -----             | 64              | INT TH    | 356.0 x 198.0 x 7.1 14.02 x 7.8 x 0.28    |
| 2757328M1              | FM1359          | BRONZE   | SPIRAL            | 45              | INT TH    | 133.1 x 92.7 x 1.6 5.24 x 3.65 x 0.063    |
| 2815281M1              | FM1613          | BRONZE   | SPR/WAG           | 120             | EXT TH    | 384.0 x 291.3 x 4.7 15.12 x 11.47 x 0.185 |
| 3045475M1              | FM4559          | BRONZE   | WAFFLE            | 29              | INT TH    | 135.5 x 44.0 x 3.3 5.33 x 1.73 x 0.128    |
| 3310959M1              | FM8579          | BRONZE   | WAF/RAD           | 32              | INT TH    | 140.2 x 100.0 x 2.1 5.52 x 3.94 x 0.08    |
| 3310963M1              | FM8582MP        | STEEL    | -----             | 6               | EXT LG    | 150.7 x 98.1 x 1.5 5.93 x 3.86 x 0.059    |
| 3380442M1              | FM5946MP        | STEEL    | -----             | 1               | EXT LG    | 136.0 x 82.5 x 4.8 5.35 x 3.25 x 0.189    |
| 3381495M1              | FM5203          | BRONZE   | WAF/RAD           | 57              | INT TH    | 128.5 x 87.7 x 2.5 5.06 x 3.45 x 0.098    |
| 3381567M1              | FM5533          | BRONZE   | WAFFLE            | 27              | (42)IN TH | 161.7 x 130.0 x 2.7 6.37 x 5.12 x 0.104   |
| 3382241M1              | FM5542MP        | STEEL    | -----             | 3               | EXT LG    | 136.2 x 95.0 x 2.0 5.36 x 3.74 x 0.079    |
| 3384488M1              | FM5540MP        | STEEL    | -----             | 34              | INT TH    | 142.0 x 66.0 x 1.8 5.59 x 2.6 x 0.069     |
| 3385987M1              | FM4543          | BRONZE   | WAFFLE            | 24              | INT TH    | 144.3 x 46.0 x 3.6 5.68 x 1.81 x 0.142    |
| 3386896M91             | FM2699          | PAPER    | 4 PASS            | 13              | INT TH    | 355.0 x 70.0 x 7.8 13.98 x 2.75 x 0.307   |
| 3386897M92             | FM2785          | PAPER    | 4 PASS            | 14              | INT TH    | 355.0 x 70.0 x 7.8 13.98 x 2.75 x 0.307   |
| 3387346M1              | FM7490MP        | STEEL    | -----             | 6               | EXT LG    | 164.7 x 95.8 x 2.5 6.48 x 3.77 x 0.098    |
| 3387347M1              | FM7487          | BRONZE   | WAF/RAD           | 57              | INT TH    | 134.8 x 87.9 x 3.5 5.31 x 3.46 x 0.138    |
| 3581334M2              | FM8461          | BRONZE   | SUNBURST          | 6               | INT LG    | 221.6 x 154.3 x 4.0 8.72 x 6.07 x 0.157   |
| 3583412M1              | FM8463          | BRONZE   | SUNBURST          | 42              | INT TH    | 221.6 x 164.3 x 4.0 8.72 x 6.47 x 0.157   |
| 3613538M1              | FM3222MP        | STEEL    | -----             | 1               | EXT LG    | 228.6 x 127.0 x 2.7 9.0 x 5.0 x 0.106     |
| 3616400M2              | FM5205          | BRONZE   | WAFFLE            | 6               | EXT LG    | 156.5 x 110.0 x 2.9 6.16 x 4.33 x 0.114   |
| 3616538M92             | FM2785          | PAPER    | 4 PASS            | 14              | INT TH    | 355.0 x 70.0 x 7.8 13.98 x 2.75 x 0.307   |
| 3616741M1              | FM7693          | BRONZE   | WAF/RAD           | 6               | EXT LG    | 234.7 x 177.8 x 2.5 9.24 x 7 x 0.098      |
| 3616742M1              | FM7696MP        | STEEL    | -----             | 6               | INT LG    | 212.0 x 149.0 x 2.5 8.35 x 5.87 x 0.98    |
| 3616745M1              | FM7697          | BRONZE   | WAFFLE            | 27              | INT TH    | 128.0 x 54.5 x 2.5 5.04 x 2.15 x 0.098    |
| 3616746M1              | FM7700MP        | STEEL    | -----             | 6               | EXT LG    | 145.5 x 84.5 x 2.5 5.73 x 3.33 x 0.098    |
| 3616749M1              | FM5300BR        | STEEL    | BRAKE ROTOR       | 6               | HOLES     | 212.0 x 84.5 x 6.0 8.45 x 3.33 x 0.236    |
| 3617344M1              | FM8034MP        | STEEL    | -----             | 6               | INT LG    | 174.3 x 124.3 x 3.5 6.86 x 4.89 x 0.136   |
| 3617346M1              | FM8031          | BRONZE   | WAF/RAD           | 6               | EXT LG    | 191.7 x 143.5 x 2.5 7.55 x 5.65 x 0.098   |
| 3617347M1              | FM7701          | BRONZE   | WAFFLE            | 27              | INT TH    | 99.7 x 54.5 x 2.5 3.93 x 2.15 x 0.098     |
| 3617348M1              | FM8030MP        | STEEL    | -----             | 6               | EXT LG    | 123.0 x 72.5 x 2.5 4.84 x 2.85 x 0.098    |
| 3617649M91             | FM7411          | PAPER    | 3 PASS            | 14              | INT TH    | 343.2 x 70.0 x 5.0 13.51 x 2.76 x 0.197   |
| 3617652M91             | FM3447          | PAPER    | 3 PASS            | 13              | INT TH    | 342.0 x 64.0 x 5.0 14.46 x 2.51 x 0.197   |
| 3617653M91             | FM3449          | PAPER    | 3 PASS            | 14              | INT TH    | 342.0 x 70.0 x 5.0 13.46 x 2.76 x 0.197   |
| 3619155M1              | FM5211          | PAPER    | WAFFLE            | 25              | (30)IN TH | 230.0 x 150.0 x 2.5 9.06 x 5.91 x 0.098   |
| 3619156M1              | FM5214MP        | STEEL    | -----             | 6               | EXT LG    | 260.0 x 162.5 x 4.0 10.24 x 6.4 x 0.157   |
| 3700134M1              | FM4071          | PAPER    | 2 PASS            | 27              | INT TH    | 223.5 x 55.0 x 4.8 8.8 x 2.17 x 0.189     |
| 3715250M2              | FM4559          | BRONZE   | WAFFLE            | 29              | INT TH    | 135.5 x 44.0 x 3.3 5.33 x 1.73 x 0.128    |
| 3761845M91 KIT         | FM8651          | PAPER    | 2 PASS            | 8               | EXT LG    | 184.8 x 155.3 x 2.0 7.28 x 6.11 x 0.079   |
| 3761845M91 KIT         | FM8696MP        | STEEL    | -----             | 6               | INT LG    | 175.9 x 146.7 x 1.5 6.93 x 5.78 x 0.059   |
| 3779323M1              | FM5926MP        | STEEL    | -----             | 69              | EXT TH    | 177.0 x 132.0 x 1.9 6.97 x 5.2 x 0.075    |
| 3779323M2              | FM5926MP        | STEEL    | -----             | 69              | EXT TH    | 177.0 x 132.0 x 1.9 6.97 x 5.2 x 0.075    |
| 3779324M1              | FM5923          | PAPER    | 2 PASS            | 60              | INT TH    | 169.0 x 124.6 x 2.8 6.65 x 4.91 x 0.11    |
| 3779324M2              | FM5923          | PAPER    | 2 PASS            | 60              | INT TH    | 169.0 x 124.6 x 2.8 6.65 x 4.91 x 0.11    |
| 3790270M1              | FM8743          | PAPER    | WAFFLE            | 6               | INT LG    | 286.0 x 201.8 x 3.5 11.26 x 7.94 x 0.138  |
| 3790271M1              | FM9062MP        | STEEL    | -----             | 6               | EXT LG    | 334.5 x 218.8 x 4.0 13.17 x 8.61 x 0.156  |
| 3790493M1              | FM4557          | BRONZE   | WAFFLE            | 24              | INT TH    | 164.5 x 41.0 x 3.6 6.48 x 1.61 x 0.142    |
| 3795093M1              | FM8857          | BRONZE   | WAF/RAD           | 34              | INT TH    | 165.2 x 66.2 x 4.3 6.5 x 2.61 x 0.169     |

| REPLACES<br>OEM PT.NO. | FMC<br>PART NO. | MATERIAL  | GROOVE<br>DETAILS | TEETH/<br>TANGS | SIZE MM   | SIZE INCH                                 |
|------------------------|-----------------|-----------|-------------------|-----------------|-----------|---|
| 3795094M1              | FM7414MP        | STEEL     | -----             | 1               | EXT SL    | 171.6 x 98.1 x 5.0 6.76 x 3.86 x 0.197    |
| 3795499M1              | FM7505          | PAPER     | 4 PASS            | 14              | INT TH    | 354.0 x 70.0 x 5.0 13.94 x 2.76 x 0.197   |
| 3795762M1              | FM7503          | PAPER     | 4 PASS            | 14              | INT TH    | 353.9 x 70.0 x 5.2 13.93 x 2.76 x 0.202   |
| 3798531M1              | FM8565          | PAPER     | 4 PASS            | 13              | INT TH    | 352.7 x 63.9 x 4.8 13.89 x 2.52 x 0.189   |
| 3811462M91             | FM8575          | PAPER     | WAFFLE            | 30              | (36)IN TH | 187.7 x 111.7 x 2.5 7.39 x 4.4 x 0.098    |
| 3811462M91 KIT         | FM8578MP        | STEEL     | -----             | 8               | EXT LG    | 201.0 x 122.0 x 3.5 7.91 x 4.8 x 0.138    |
| 3819877M91 KIT         | FM8575          | PAPER     | WAFFLE            | 30              | (36)IN TH | 187.7 x 111.7 x 2.5 7.39 x 4.4 x 0.098    |
| 3819877M91             | FM8578MP        | STEEL     | -----             | 8               | EXT LG    | 201.0 x 122.0 x 3.5 7.91 x 4.8 x 0.138    |
| 3823952M1              | FM4071          | PAPER     | 2 PASS            | 27              | INT TH    | 223.5 x 55.0 x 4.8 8.8 x 2.17 x 0.189     |
| 3825367M1              | FM8563          | CARBON PA | WAFFLE            | 27              | INT TH    | 223.5 x 54.9 x 4.8 8.8 x 2.16 x 0.189     |
| 3900247M91             | FM8031          | BRONZE    | WAF/RAD           | 6               | EXT LG    | 191.7 x 143.5 x 2.5 7.55 x 5.65 x 0.098   |
| 3900248M91             | FM7701          | BRONZE    | WAFFLE            | 27              | INT TH    | 99.7 x 54.5 x 2.5 3.93 x 2.15 x 0.098     |
| 3900258M91             | FM7693          | BRONZE    | WAF/RAD           | 6               | EXT LG    | 234.7 x 177.8 x 2.5 9.24 x 7.0 x 0.098    |
| 3900259M91             | FM7697          | BRONZE    | WAFFLE            | 27              | INT TH    | 128.0 x 54.5 x 2.5 5.04 x 2.15 x 0.098    |
| 4232319M1              | FM3824MP        | STEEL     | -----             | 2               | EXT LG    | 195.0 x 110.0 x 2.6 7.68 x 4.33 x 0.102   |
| 4232320M1              | FM3103          | GRAPHITE  | WAFFLE            | 28              | INT TH    | 169.0 x 56.0 x 4.8 6.65 x 2.21 x 0.189    |
| 6190039M1              | FM3701          | PAPER     | 2 PASS            | 43              | (45)IN TH | 133.1 x 92.7 x 2.1 5.24 x 3.65 x 0.084    |
| 6190042M1              | FM1324MP        | STEEL     | -----             | 54              | EXT TH    | 139.2 x 98.6 x 1.8 5.48 x 3.88 x 0.07     |
| 6190105M1              | FM3264MP        | STEEL     | -----             | 26              | EXT TH    | 143.5 x 89.5 x 2.2 5.65 x 3.52 x 0.084    |
| 6190106M1              | FM3261          | PAPER     | 2 PASS            | 40              | INT TH    | 127.1 x 82.2 x 2.5 5.0 x 3.24 x 0.98      |
| 6190295M1              | FM3095          | GRAPHITE  | SUNBURST          | 13              | INT TH    | 215.0 x 36.5 x 10.0 8.46 x 1.44 x 0.394   |
| 6193507M1              | FM4995          | PAPER     | 2 PASS/PLAIN      | 54              | EXT TH    | 139.0 x 99.0 x 2.0 5.47 x 3.9 x 0.077     |
| 6193508M1              | FM4998MP        | STEEL     | -----             | 45              | INT TH    | 133.0 x 92.7 x 2.0 5.24 x 3.65 x 0.079    |
| 6193509M1              | FM4993          | PAPER     | 2 PASS            | 54              | EXT TH    | 139.0 x 99.0 x 2.7 5.47 x 3.9 x 0.104     |
| 6523693M1              | FM5203          | BRONZE    | WAF/RAD           | 57              | INT TH    | 128.5 x 87.7 x 2.5 5.06 x 3.45 x 0.098    |
| 887890M91              | FM0623          | OBSOLETE  | -----             |                 | FACING    | 301.5 x 190.5 x 4.1 11.87 x 7.5 x 0.16    |
| 80104609               | FM1179          | GRAPHITE  | SUNBURST          | 60              | INT TH    | 253.5 x 187.5 x 3.9 9.98 x 7.38 x 0.153   |
| VA117167               | FM3356MP        | STEEL     | -----             | 1               | EXT LG    | 172.0 x 94.0 x 2.7 6.77 x 3.7 x 0.104     |
| VA143847               | FM5201          | PAPER     | WAFFLE            | 22              | INT TH    | 165.0 x 41.0 x 4.7 6.5 x 1.61 x 0.185     |
| <b>MATBRO</b>          |                 |           |                   |                 |           |   |
| 500919                 | FM2181          | BRONZE    | SUNBURST          | 19              | INT TH    | 177.8 x 34.3 x 4.8 7.0 x 1.35 x 0.189     |
| 500920                 | FM2184MP        | STEEL     | -----             | 3               | EXT SL    | 201.7 x 129.5 x 2.7 7.94 x 5.1 x 0.106    |
| 501544                 | FM2781          | GRAPHITE  | SUNBURST          | 15              | INT TH    | 213.0 x 44.0 x 10.0 8.38 x 1.73 x 0.394   |
| 502697                 | FM2777          | GRAPHITE  | SUNBURST          | 27              | INT TH    | 260.0 x 66.1 x 10.0 10.24 x 2.6 x 0.394   |
| 503259                 | FM2632MP        | STEEL     | -----             | 6               | EXT LG    | 199.0 x 130 x 2.6 7.83 x 5.12 x 0.102     |
| 503260                 | FM2647          | PAPER     | 2 PASS            | 19              | IN TH     | 178.0 x 34.0 x 4.8 7.01 x 1.34 x 0.189    |
| 503910                 | FM2715          | PAPER     | 2 PASS            | 19              | INT TH    | 152.0 x 34.0 x 4.8 5.98 x 1.34 x 0.189    |
| 504598                 | FM2647          | PAPER     | 2 PASS            | 19              | IN TH     | 178.0 x 34.0 x 4.8 7.01 x 1.34 x 0.189    |
| 4802056                | FM2215          | BRONZE    | SPR/WAG           | 22              | INT TH    | 204.5 x 53.3 x 4.8 8.05 x 2.1 x 0.19      |
| ALTERNATIVE            | FM3035          | PAPER     | WAFFLE            | 22              | INT TH    | 204.5 x 53.3 x 4.8 8.05 x 2.1 x 0.189     |
| <b>MERCEDES BUS</b>    |                 |           |                   |                 |           |   |
| 000 257 0047           | FM3962MP        | STEEL     | -----             | 64              | (76)EX TH | 362.0 x 308.0 x 4.0 14.25 x 12.12 x 0.158 |
| 000 272 0925           | FM3998MP        | STEEL     | "M"               | 45              | EXT TH    | 281.0 x 221.0 x 3.0 11.05 x 8.7 x 0.118   |
| 000 272 1025           | FM3965          | PAPER     | 2 PASS            | 43              | INT TH    | 257.0 x 212.0 x 3.0 10.11 x 8.34 x 0.117  |
| 000 272 1125           | FM3974MP        | STEEL     | -----             | 32              | INT TH    | 163.0 x 94.0 x 2.5 6.41 x 3.69 x 0.098    |

| REPLACES<br>OEM PT.NO.            | FMC<br>PART NO. | MATERIAL  | GROOVE<br>DETAILS | TEETH/<br>TANGS | SIZE MM   | SIZE INCH                                 |
|-----------------------------------|-----------------|-----------|-------------------|-----------------|-----------|---|
| 000 272 1225                      | FM3972MP        | STEEL     | -----             | 32              | INT TH    | 163.0 x 94.0 x 2.0 6.41 x 3.69 x 0.079    |
| 000 257 1747                      | FM5304-3.5      | STEEL     | -----             | 8               | EXT LG    | 417.6 x 354.0 x 3.5 16.44 x 14.33 x 0.138 |
| 000 272 2125                      | FM3889          | BRONZE    | SPR/RAD           | 48              | INT TH    | 278.0 x 238.0 x 3.0 10.94 x 9.37 x 0.117  |
| 000 272 3125                      | FM3967          | PAPER     | 2 PASS            | 46              | INT TH    | 278.0 x 228.0 x 2.7 10.84 x 8.98 x 0.106  |
| 000 272 3225                      | FM3965          | PAPER     | 2 PASS            | 43              | INT TH    | 257.0 x 212.0 x 3.0 10.11 x 8.34 x 0.117  |
| 000 272 3826                      | FM3978MP        | STEEL     | -----             | 34              | (45)EX TH | 281.0 x 221.0 x 2.5 11.05 x 8.7 x 0.098   |
| 000 272 3926                      | FM3976MP        | STEEL     | -----             | 34              | (45)EX TH | 281.0 x 221.0 x 2.0 11.05 x 8.7 x 0.079   |
| 000 272 4026                      | FM3992MP        | STEEL     | HOLES             | 24              | (32)EX TH | 306.0 x 237.0 x 3.0 12.03 x 9.3 x 0.118   |
| 000 272 4126                      | FM3990MP        | STEEL     | HOLES             | 24              | (32)EX TH | 306.0 x 237.0 x 2.5 12.03 x 9.3 x 0.098   |
| 000 272 4226                      | FM3988MP        | STEEL     | HOLES             | 24              | (32)EX TH | 306.0 x 237.0 x 2.0 12.03 x 9.3 x 0.079   |
| 000 272 4326                      | FM3986MP        | STEEL     | -----             | 24              | (32)EX TH | 306.0 x 237.0 x 3.0 12.03 x 9.3 x 0.118   |
| 000 272 4926                      | FM3892MP        | STEEL     | 8 HOLES           | 24              | (32)EX TH | 306.0 x 247.0 x 2.0 12.03 x 9.72 x 0.079  |
| 000 272 5426                      | FM3982MP        | STEEL     | -----             | 24              | (32)EX TH | 306.0 x 237.0 x 2.0 12.03 x 9.3 x 0.079   |
| 000 272 5626                      | FM4488MP        | STEEL     | -----             | 24              | (32)EX TH | 306.0 x 237.0 x 3.5 12.03 x 9.3 x 0.137   |
| 000 272 5726                      | FM5277          | PAPER     | RADIAL            | 36              | INT LG    | 390.0 x 345.0 x 3.1 15.35 x 13.58 x 0.122 |
| 000 272 8026                      | FM3963          | PAPER     | 2 PASS            | 10              | EXT LG    | 177.0 x 126.0 x 3.0 6.97 x 4.97 x 0.117   |
| 010 250 8103                      | FM3959          | BRONZE    | WAFFLE            | 60              | INT TH    | 353.0 x 295.0 x 3.3 13.9 x 11.61 x 0.13   |
| 301 272 0426                      | FM3958-4.0      | STEEL     | -----             | 6               | EXT LG    | 308.0 x 231.0 x 4.0 12.12 x 9.09 x 0.158  |
| 301 272 0526                      | FM3958-3.0      | STEEL     | -----             | 6               | EXT LG    | 308.0 x 231.0 x 3.0 12.12 x 9.09 x 0.118  |
| 301 272 0626                      | FM3958-3.5      | STEEL     | -----             | 6               | EXT LG    | 308.0 x 231.0 x 3.5 12.12 x 9.09 x 0.138  |
| 307 270 2338                      | FM3953          | TAN PAPER | 2 PASS            | 56              | INT TH    | 282.3 x 222.0 x 3.5 11.11 x 8.74 x 0.138  |
| 307 272 0426                      | FM3958-5.0      | STEEL     | -----             | 6               | EXT LG    | 308.0 x 231.0 x 5.0 12.12 x 9.09 x 0.197  |
| 307 272 1126                      | FM3958-4.5      | STEEL     | -----             | 6               | EXT LG    | 308.0 x 231.0 x 4.5 12.12 x 9.09 x 0.177  |
| 307 272 1426                      | FM3956-3.0      | STEEL     | -----             | 10              | EXT LG    | 308.0 x 231.0 x 3.0 12.12 x 9.09 x 0.118  |
| 307 272 1526                      | FM3956-4.0      | STEEL     | -----             | 10              | EXT LG    | 308.0 x 231.0 x 4.0 12.12 x 9.09 x 0.158  |
| 307 272 1626                      | FM3956-5.0      | STEEL     | -----             | 10              | EXT LG    | 308.0 x 231.0 x 5.0 12.12 x 9.09 x 0.197  |
| 307 272 2525                      | FM3952-2.5      | STEEL     | -----             | 8               | INT LG    | 197.5 x 151.0 x 2.5 7.78 x 5.94 x 0.098   |
| 307 272 2625                      | FM3952-3.0      | STEEL     | -----             | 8               | INT LG    | 197.5 x 151.0 x 3.0 7.78 x 5.94 x 0.118   |
| 307 272 2725                      | FM3952-3.5      | STEEL     | -----             | 8               | INT LG    | 197.5 x 151.0 x 3.5 7.78 x 5.94 x 0.138   |
| 307 272 2825                      | FM3952-5.0      | STEEL     | -----             | 8               | INT LG    | 197.5 x 151.0 x 5.0 7.78 x 5.94 x 0.197   |
| 307 272 3825                      | FM3952-4.0      | STEEL     | -----             | 8               | INT LG    | 197.5 x 151.0 x 4.0 7.78 x 5.94 x 0.158   |
| 307 272 3925                      | FM3952-4.5      | STEEL     | -----             | 8               | INT LG    | 197.5 x 151.0 x 4.5 7.78 x 5.94 x 0.177   |
| 357 270 0138                      | FM3949          | GREEN PA  | 2 PASS            | 12              | EXT LG    | 208.8 x 161.3 x 2.8 8.22 x 6.35 x 0.11    |
| 642 272 0026                      | FM5128MP        | OBSOLETE  | -----             | 27              | (36)EX TH | 308.0 x 231.0 x 3.0 12.13 x 9.09 x 0.118  |
| 642 272 0126                      | FM5126MP        | STEEL     | -----             | 18              | (36)EX TH | 308.0 x 231.0 x 4.0 12.13 x 9.09 x 0.157  |
| <b>MICHIGAN (also see Euclid)</b> |                 |           |                   |                 |           |   |
| 3944568                           | FM5187          | PAPER     | 2 PASS            | 23              | INT TH    | 308.0 x 87.5 x 6.2 12.13 x 3.44 x 0.244   |
| <b>MINNEAPOLIS MOLINE</b>         |                 |           |                   |                 |           |   |
| 20-3000390                        | OBSOLETE        | GRAPHITE  | SUNBURST          | 36              | INT TH    | 177.8 x 111.0 x 3.2 7 x 4.37 x 0.126      |

| REPLACES OEM PT.NO. | FMC PART NO. | MATERIAL | GROOVE DETAILS | TEETH/TANGS | SIZE MM | SIZE INCH |
|---------------------|--------------|----------|----------------|-------------|---------|-----------|
|---------------------|--------------|----------|----------------|-------------|---------|-----------|

**MITSUBISHI**

|             |          |           |                |     |        |                     |                      |
|-------------|----------|-----------|----------------|-----|--------|---------------------|----------------------|
| 134G-382121 | FM4966MP | STEEL     | -----          | 24  | EXT TH | 132.0 x 80.0 x 1.6  | 5.2 x 3.15 x 0.063   |
| 52201-06390 | FM3251   | PAPER     | WAFFLE         | 40  | INT TH | 191.9 x 124.1 x 3.3 | 7.55 x 4.88 x 0.129  |
| 58822-22500 | FM4176MP | STEEL     | END PLATE      | 5   | EXT LG | 264.0 x 177.0 x 3.1 | 10.4 x 6.97 x 0.122  |
| 58822-32300 | FM4173   | PAPER     | 2 PASS         | 54  | INT TH | 215.9 x 168.6 x 3.0 | 8.5 x 6.64 x 0.116   |
| 60325-01300 | FM8418MP | STEEL     | -----          | 20  | EXT TH | 229.0 x 177.1 x 3.2 | 9.02 x 4.61 x 0.126  |
| 60332-00800 | FM4241   | PAPER     | 2 PASS         | 48  | INT TH | 195.0 x 120.0 x 2.9 | 7.68 x 4.72 x 0.114  |
| 60332-00801 | FM4241   | PAPER     | 2 PASS         | 48  | INT TH | 195.0 x 120.0 x 2.9 | 7.68 x 4.72 x 0.114  |
| 60335-00200 | FM2763   | PAPER     | 2 PASS         | 71  | INT TH | 314.0 x 207.0 x 3.7 | 12.36 x 8.15 x 0.144 |
| 62625-05200 | FM4169   | PAPER     | 2 PASS         | 101 | INT TH | 311.0 x 253.0 x 4.6 | 12.24 x 9.96 x 0.181 |
| 62625-05201 | FM4169   | PAPER     | 2 PASS         | 101 | INT TH | 311.0 x 253.0 x 4.6 | 12.24 x 9.96 x 0.181 |
| 62635-00300 | FM2763   | PAPER     | 2 PASS         | 71  | INT TH | 314.0 x 207.0 x 3.7 | 12.36 x 8.15 x 0.144 |
| 62635-00400 | FM2774MP | STEEL     | -----          | 110 | EXT TH | 336.0 x 234.0 x 2.5 | 13.23 x 9.21 x 0.098 |
| 64323-45200 | FM2122MP | STEEL     | -----          | 4   | EXT LG | 137.7 x 80.0 x 2.2  | 5.42 x 3.15 x 0.087  |
| 64323-45300 | FM2133   | PAPER     | 2 PASS         | 41  | INT TH | 125.0 x 68.6 x 3.6  | 4.92 x 2.7 x 0.142   |
| 65425-13700 | FM2133   | PAPER     | 2 PASS         | 41  | INT TH | 125.0 x 68.6 x 3.6  | 4.92 x 2.7 x 0.142   |
| 65425-13800 | FM2122MP | STEEL     | -----          | 4   | EXT LG | 137.7 x 80.0 x 2.2  | 5.42 x 3.15 x 0.087  |
| 65425-23800 | FM2122MP | STEEL     | -----          | 4   | EXT LG | 137.7 x 80.0 x 2.2  | 5.42 x 3.15 x 0.087  |
| 65727-03200 | FM2061   | PAPER     | WAFFLE         | 41  | INT TH | 125.0 x 68.6 x 2.6  | 4.92 x 2.7 x 0.102   |
| 69241-00802 | FM4171   | PAPER     | 2 PASS         | 108 | INT TH | 280.0 x 212.0 x 3.8 | 11.02 x 8.35 x 0.15  |
| 69241-00901 | FM8426MP | STEEL     | SPRING POCKETS | 5   | EXT LG | 335.3 x 224.5 x 5.0 | 13.2 x 8.84 x 0.197  |
| 69241-01101 | FM8420MP | STEEL     | -----          | 5   | EXT LG | 322.2 x 224.5 x 5.0 | 12.69 x 8.84 x 0.197 |
| 69241-03400 | FM4430MP | STEEL     | -----          | 5   | EXT LG | 353.0 x 263.0 x 5.0 | 13.9 x 10.35 x 0.197 |
| 69241-03403 | FM4430MP | STEEL     | -----          | 5   | EXT LG | 353.0 x 263.0 x 5.0 | 13.9 x 10.35 x 0.197 |
| 69242-03800 | FM2124MP | STEEL     | -----          | 6   | EXT LG | 169.9 x 100.1 x 2.2 | 6.69 x 3.94 x 0.087  |
| 69242-13700 | FM2129   | PAPER     | 2 PASS         | 37  | INT TH | 156.0 x 88.0 x 2.9  | 6.14 x 3.46 x 0.114  |
| 69242-13800 | FM3720MP | STEEL     | -----          | 6   | EXT LG | 170.0 x 100.0 x 2.0 | 6.69 x 3.94 x 0.079  |
| 69271-23400 | FM7053   | PAPER     | 3 PASS         | 79  | INT TH | 468.0 x 310.0 x 4.8 | 18.43 x 12.2 x 0.189 |
| 69271-38600 | FM6511   | PAPER     | WAFFLE         | 79  | INT TH | 468.0 x 310.0 x 4.7 | 18.43 x 12.2 x 0.183 |
| 91224-06500 | FM2133   | PAPER     | 2 PASS         | 41  | INT TH | 125.0 x 68.6 x 3.6  | 4.92 x 2.7 x 0.142   |
| 91224-16500 | FM2133   | PAPER     | 2 PASS         | 41  | INT TH | 125.0 x 68.6 x 3.6  | 4.92 x 2.7 x 0.142   |
| 91324-02700 | FM2061   | PAPER     | WAFFLE         | 41  | INT TH | 125.0 x 68.6 x 2.6  | 4.92 x 2.7 x 0.102   |
| 91324-02701 | FM2061   | PAPER     | WAFFLE         | 41  | INT TH | 125.0 x 68.6 x 2.6  | 4.92 x 2.7 x 0.102   |
| 91324-02702 | FM2061   | PAPER     | WAFFLE         | 41  | INT TH | 125.0 x 68.6 x 2.6  | 4.92 x 2.7 x 0.102   |
| 91324-04700 | FM5130MP | STEEL     | END PLATE      | 24  | EXT TH | 132.0 x 80.0 x 3.9  | 5.2 x 3.15 x 0.152   |
| 91324-12600 | FM3368MP | STEEL     | -----          | 24  | EXT TH | 132.0 x 80.0 x 1.6  | 5.2 x 3.15 x 0.063   |
| 91324-12601 | FM3368MP | STEEL     | -----          | 24  | EXT TH | 132.0 x 80.0 x 1.6  | 5.2 x 3.15 x 0.063   |
| 91524-14300 | FM1805   | BRONZE    | SUNBURST       | 41  | INT TH | 125.0 x 68.6 x 2.6  | 4.92 x 2.7 x 0.102   |
| 91824-08100 | FM2131   | PAPER     | 2 PASS         | 37  | INT TH | 155.7 x 87.9 x 2.6  | 6.13 x 3.46 x 0.102  |
| 91824-08101 | FM2131   | PAPER     | 2 PASS         | 37  | INT TH | 155.7 x 87.9 x 2.6  | 6.13 x 3.46 x 0.102  |
| 91824-08200 | FM2124MP | STEEL     | -----          | 6   | EXT LG | 169.9 x 100.1 x 2.2 | 6.69 x 3.94 x 0.087  |
| 91824-12600 | FM2129   | PAPER     | 2 PASS         | 37  | INT TH | 155.7 x 87.9 x 2.9  | 6.13 x 3.46 x 0.114  |
| 91824-12700 | FM2018MP | STEEL     | -----          | 12  | EXT LG | 165.6 x 100.1 x 2.0 | 6.52 x 3.94 x 0.079  |
| 91B24-00800 | FM6349   | CARBON PA | 2 PASS         | 41  | INT TH | 125.0 x 68.6 x 2.6  | 4.92 x 2.7 x 0.102   |
| 91B24-02200 | FM2061   | PAPER     | WAFFLE         | 41  | INT TH | 125.0 x 68.6 x 2.6  | 4.92 x 2.7 x 0.102   |
| 91B24-02300 | FM3368MP | STEEL     | -----          | 24  | EXT TH | 132.0 x 80.0 x 1.6  | 5.2 x 3.15 x 0.063   |
| 91B24-02400 | FM5130MP | STEEL     | END PLATE      | 24  | EXT TH | 132.0 x 80.0 x 3.9  | 5.2 x 3.15 x 0.152   |
| 92226-08800 | FM2131   | PAPER     | 2 PASS         | 37  | INT TH | 155.7 x 87.9 x 2.6  | 6.13 x 3.46 x 0.102  |

| REPLACES<br>OEM PT.NO. | FMC<br>PART NO. | MATERIAL             | GROOVE<br>DETAILS | TEETH/<br>TANGS | SIZE MM   |       |   | SIZE INCH |   |     |       |   |       |   |       |
|------------------------|-----------------|----------------------|-------------------|-----------------|-----------|-------|---|-----------|---|-----|-------|---|-------|---|-------|
| 92226-09600            | FM2124MP        | STEEL                | -----             | 6               | EXT LG    | 169.9 | x | 100.1     | x | 2.2 | 6.69  | x | 3.94  | x | 0.087 |
| 92227-03600            | FM2131          | PAPER                | 2 PASS            | 37              | INT TH    | 155.7 | x | 87.9      | x | 2.6 | 6.13  | x | 3.46  | x | 0.102 |
| 92326-13100            | FM4731          | PAPER                | WAFFLE            | 78              | INT TH    | 248.0 | x | 195.0     | x | 3.6 | 9.76  | x | 7.68  | x | 0.14  |
| 92326-13200            | FM2444MP        | STEEL                | -----             | 5               | EXT LG    | 293.9 | x | 203.5     | x | 3.2 | 11.57 | x | 8.01  | x | 0.125 |
| 92326-13300            | FM2444MP        | STEEL                | -----             | 5               | EXT LG    | 293.9 | x | 203.5     | x | 3.2 | 11.57 | x | 8.01  | x | 0.125 |
| 92326-13300            | FM4734MP        | OBSOLETE AFTER STOCK |                   | 5               | EXT LG    | 293.9 | x | 203.5     | x | 3.2 | 11.57 | x | 8.01  | x | 0.126 |
| 92326-24701            | FM4731          | PAPER                | WAFFLE            | 78              | INT TH    | 248.0 | x | 195.0     | x | 3.6 | 9.76  | x | 7.68  | x | 0.14  |
| 92434-01500            | FM9109          | PAPER                | 3 PASS            | 63              | INT TH    | 381.0 | x | 246.0     | x | 4.7 | 15.0  | x | 9.69  | x | 0.183 |
| 92434-01600            | FM9112MP        | STEEL                | -----             | 78              | EXT TH    | 393.6 | x | 282.2     | x | 3.1 | 15.5  | x | 11.11 | x | 0.122 |
| 92525-02800            | FM4428MP        | STEEL                | -----             | 5               | EXT LG    | 320.0 | x | 224.0     | x | 3.5 | 12.6  | x | 8.82  | x | 0.138 |
| 92525-13100            | FM4171          | PAPER                | 2 PASS            | 108             | INT TH    | 280.0 | x | 212.0     | x | 3.8 | 11.02 | x | 8.35  | x | 0.15  |
| 92534-03600            | FM7053          | PAPER                | 3 PASS            | 79              | INT TH    | 468.0 | x | 310.0     | x | 4.8 | 18.43 | x | 12.2  | x | 0.189 |
| 92534-03700            | FM6514MP        | STEEL                | -----             | 120             | EXT TH    | 486.0 | x | 330.0     | x | 3.1 | 19.13 | x | 12.99 | x | 0.122 |
| 92534-03800            | FM6515          | CORK                 | -----             | 120             | EXT TH    | 486.0 | x | 330.0     | x | 6.0 | 19.13 | x | 12.99 | x | 0.236 |
| 93724-02600            | FM3370MP        | STEEL                | -----             | 52              | EXT TH    | 161.5 | x | 100.0     | x | 2.3 | 6.36  | x | 3.94  | x | 0.091 |
| 93724-02601            | FM3370MP        | STEEL                | -----             | 52              | EXT TH    | 161.5 | x | 100.0     | x | 2.3 | 6.36  | x | 3.94  | x | 0.091 |
| 93724-02700            | FM5848MP        | STEEL                | END PLATE         | 52              | EXT TH    | 161.5 | x | 100.0     | x | 6.0 | 6.36  | x | 3.94  | x | 0.236 |
| MC664574               | FM4173          | PAPER                | 2 PASS            | 54              | INT TH    | 215.9 | x | 168.6     | x | 3.0 | 8.5   | x | 6.64  | x | 0.116 |
| MC664582               | FM4171          | PAPER                | 2 PASS            | 108             | INT TH    | 280.0 | x | 212.0     | x | 3.8 | 11.02 | x | 8.35  | x | 0.15  |
| NL540012165            | FM7403          | BRONZE               | WAFFLE            | 20              | INT TH    | 105.1 | x | 50.2      | x | 2.0 | 4.14  | x | 1.98  | x | 0.079 |
| 50C2506200             | FM6293          | OBSOLETE AFTER STOCK |                   | 32              | (41)IN TH | 88.6  | x | 60.1      | x | 1.5 | 3.49  | x | 2.37  | x | 0.06  |
| <b>MITSUI TCM</b>      |                 |                      |                   |                 |           |       |   |           |   |     |       |   |       |   |       |
| 10433-40091            | FM0647          | BRONZE               | SUNBURST          | 19              | INT TH    | 165.1 | x | 74.2      | x | 4.0 | 6.5   | x | 2.92  | x | 0.156 |
| 10433-40916            | FM0647          | BRONZE               | SUNBURST          | 19              | INT TH    | 165.1 | x | 74.2      | x | 4.0 | 6.5   | x | 2.92  | x | 0.156 |
| 11243-82141            | FM2061          | PAPER                | WAFFLE            | 41              | INT TH    | 125.0 | x | 68.6      | x | 2.6 | 4.92  | x | 2.7   | x | 0.102 |
| 11243-82151            | FM1844MP        | STEEL                | -----             | 8               | EXT LG    | 134.4 | x | 81.0      | x | 1.6 | 5.29  | x | 3.19  | x | 0.063 |
| 112T2-52261            | FM3358MP        | STEEL                | -----             | 6               | EXT LG    | 143.5 | x | 88.5      | x | 2.0 | 5.65  | x | 3.48  | x | 0.079 |
| 112T2-52281            | FM3561          | PAPER                | WAFFLE            | 30              | INT TH    | 131.0 | x | 79.2      | x | 2.6 | 5.16  | x | 3.12  | x | 0.102 |
| 115G3-82751            | FM2061          | PAPER                | WAFFLE            | 41              | INT TH    | 125.0 | x | 68.6      | x | 2.6 | 4.92  | x | 2.7   | x | 0.102 |
| 115G3-82761            | FM2926MP        | STEEL                | -----             | 8               | EXT LG    | 136.7 | x | 81.0      | x | 1.8 | 5.38  | x | 3.19  | x | 0.071 |
| 123S-82111             | FM4736MP        | STEEL                | -----             | 8               | EXT LG    | 134.5 | x | 81.0      | x | 1.8 | 5.3   | x | 3.19  | x | 0.071 |
| 124U3-82351B           | FM6609          | CARBON PA            | WAFFLE            | 38              | INT TH    | 133.6 | x | 77.0      | x | 2.8 | 5.26  | x | 3.03  | x | 0.11  |
| 124U3-82361A           | FM3726MP        | STEEL                | -----             | 8               | EXT LG    | 152.6 | x | 87.0      | x | 3.0 | 6.0   | x | 3.43  | x | 0.118 |
| 134B3-82401            | FM2061          | PAPER                | WAFFLE            | 41              | INT TH    | 125.0 | x | 68.6      | x | 2.6 | 4.92  | x | 2.7   | x | 0.102 |
| 134B3-82411            | FM2926MP        | STEEL                | -----             | 8               | EXT LG    | 136.7 | x | 81.0      | x | 1.8 | 5.38  | x | 3.19  | x | 0.071 |
| 134G3-82121            | FM4966MP        | STEEL                | -----             | 24              | EXT TH    | 132.0 | x | 80.0      | x | 1.6 | 5.2   | x | 3.15  | x | 0.063 |
| 134G3-82131            | FM5130MP        | STEEL                | END PLATE         | 24              | EXT TH    | 132.0 | x | 80.0      | x | 3.9 | 5.2   | x | 3.15  | x | 0.152 |
| 15943-82451            | FM3724MP        | STEEL                | -----             | 8               | EXT LG    | 152.6 | x | 87.0      | x | 2.0 | 6.0   | x | 3.43  | x | 0.079 |
| 15943-82452            | FM3726MP        | STEEL                | -----             | 8               | EXT LG    | 152.6 | x | 87.0      | x | 3.0 | 6.0   | x | 3.43  | x | 0.118 |
| 15943-82462            | FM2927          | PAPER                | 2 PASS            | 38              | INT TH    | 133.6 | x | 77.0      | x | 2.6 | 5.26  | x | 3.03  | x | 0.102 |
| 15943-83141            | FM4754MP        | STEEL                | DISHED            | 8               | EXT LG    | 151.7 | x | 88.0      | x | 3.5 | 5.97  | x | 3.46  | x | 0.138 |
| 15943-83241A           | FM2930MP        | STEEL                | -----             | 8               | EXT LG    | 152.2 | x | 87.3      | x | 4.0 | 5.99  | x | 3.44  | x | 0.157 |
| 20802-51971            | FM4391          | PAPER                | 2 PASS            | 41              | INT TH    | 125.0 | x | 68.6      | x | 2.1 | 4.92  | x | 2.7   | x | 0.081 |
| 90208-77300            | FM1816MP        | STEEL                | DISHED            | 32              | (42)EX TH | 184.2 | x | 92.7      | x | 2.6 | 7.25  | x | 3.65  | x | 0.102 |
| 90208-77311A           | FM1816MP        | STEEL                | DISHED            | 32              | (42)EX TH | 184.2 | x | 92.7      | x | 2.6 | 7.25  | x | 3.65  | x | 0.102 |
| 90209-92800            | FM0647          | BRONZE               | SUNBURST          | 19              | INT TH    | 165.1 | x | 74.2      | x | 4.0 | 6.5   | x | 2.92  | x | 0.156 |



| REPLACES<br>OEM PT.NO. | FMC<br>PART NO. | MATERIAL | GROOVE<br>DETAILS | TEETH/<br>TANGS |           | SIZE MM |   |       | SIZE INCH |     |      |   |      |   |       |
|------------------------|-----------------|----------|-------------------|-----------------|-----------|---------|---|-------|-----------|-----|------|---|------|---|-------|
| 90217-16202            | FM1278MP        | STEEL    | -----             | 14              | (20)EX TH | 218.9   | x | 158.8 | x         | 2.7 | 8.62 | x | 6.25 | x | 0.106 |
| 90217-75700            | FM1195          | BRONZE   | SUNBURST          | 60              | INT TH    | 195.1   | x | 145.0 | x         | 4.0 | 7.68 | x | 5.71 | x | 0.156 |
| 90227-49500            | FM1191          | GRAPHITE | SUNBURST          | 60              | INT TH    | 195.1   | x | 145.0 | x         | 4.0 | 7.68 | x | 5.71 | x | 0.156 |
| AE-41080-2073          | FM2926MP        | STEEL    | -----             | 8               | EXT LG    | 136.7   | x | 81.0  | x         | 1.8 | 5.38 | x | 3.19 | x | 0.071 |
| AE-41080-2073A         | FM2926MP        | STEEL    | -----             | 8               | EXT LG    | 136.7   | x | 81.0  | x         | 1.8 | 5.38 | x | 3.19 | x | 0.071 |
| AE-41080-2074          | FM1805          | BRONZE   | SUNBURST          | 41              | INT TH    | 125.0   | x | 68.6  | x         | 2.6 | 4.92 | x | 2.7  | x | 0.102 |
| AE-41080-2074A         | FM1805          | BRONZE   | SUNBURST          | 41              | INT TH    | 125.0   | x | 68.6  | x         | 2.6 | 4.92 | x | 2.7  | x | 0.102 |
| AE-41080-2075A         | FM3368MP        | STEEL    | -----             | 24              | EXT TH    | 132.0   | x | 80.0  | x         | 1.6 | 5.2  | x | 3.15 | x | 0.063 |
| AE-41080-2076          | FM2083          | BRONZE   | WAFFLE            | 41              | INT TH    | 125.0   | x | 68.6  | x         | 2.1 | 4.92 | x | 2.7  | x | 0.083 |
| AE-602-893-102         | FM1805          | BRONZE   | SUNBRST           | 41              | INT TH    | 125.0   | x | 68.6  | x         | 2.6 | 4.92 | x | 2.7  | x | 0.102 |
| AE-602-893-103         | FM1805          | BRONZE   | SUNBURST          | 41              | INT TH    | 125.0   | x | 68.6  | x         | 2.6 | 4.92 | x | 2.7  | x | 0.102 |
| AE-602-893-105         | FM2061          | PAPER    | WAFFLE            | 41              | INT TH    | 125.0   | x | 68.6  | x         | 2.6 | 4.92 | x | 2.7  | x | 0.102 |
| AE-602-893-108         | FM2061          | PAPER    | WAFFLE            | 41              | INT TH    | 125.0   | x | 68.6  | x         | 2.6 | 4.92 | x | 2.7  | x | 0.102 |
| AE-602-894-104         | FM1844MP        | STEEL    | -----             | 8               | EXT LG    | 134.4   | x | 81.0  | x         | 1.6 | 5.29 | x | 3.19 | x | 0.063 |
| AE-602-894-108         | FM1844MP        | STEEL    | -----             | 8               | EXT LG    | 134.4   | x | 81.0  | x         | 1.6 | 5.29 | x | 3.19 | x | 0.063 |
| BK-703100-8000         | FM2350MP        | STEEL    | -----             | 8               | EXT LG    | 149.9   | x | 87.6  | x         | 1.5 | 5.9  | x | 3.45 | x | 0.059 |
| BK-703100-9000         | FM2135          | PAPER    | 2 PASS            | 38              | INT TH    | 133.6   | x | 77.0  | x         | 2.8 | 5.26 | x | 3.03 | x | 0.11  |
| BK-703701-0001         | FM2452MP        | STEEL    | -----             | 10              | EXT LG    | 172.2   | x | 108.0 | x         | 2.0 | 6.78 | x | 4.25 | x | 0.079 |
| BK-703701-1001         | FM2463          | PAPER    | 2 PASS            | 38              | INT TH    | 154.7   | x | 95.0  | x         | 3.7 | 6.09 | x | 3.74 | x | 0.144 |
| BK-706500-8000         | FM2352MP        | STEEL    | -----             | 8               | EXT LG    | 149.9   | x | 87.4  | x         | 2.3 | 5.9  | x | 3.44 | x | 0.091 |
| BK-708900-9000         | FM4094MP        | STEEL    | -----             | 8               | EXT LG    | 136.2   | x | 80.0  | x         | 1.6 | 5.37 | x | 3.15 | x | 0.063 |
| BK-709500-5000         | FM4620MP        | STEEL    | -----             | 8               | EXT LG    | 150.4   | x | 87.4  | x         | 2.0 | 5.92 | x | 3.44 | x | 0.079 |
| BK-726302-3000         | FM3816MP        | STEEL    | DISHED            | 8               | EXT LG    | 151.7   | x | 88.0  | x         | 3.5 | 5.97 | x | 3.46 | x | 0.136 |
| BK-750102-4000         | FM2061          | PAPER    | WAFFLE            | 41              | INT TH    | 125.0   | x | 68.6  | x         | 2.6 | 4.92 | x | 2.7  | x | 0.102 |
| BK-750110-9000         | FM2135          | PAPER    | 2 PASS            | 38              | INT TH    | 133.6   | x | 77.0  | x         | 2.8 | 5.26 | x | 3.03 | x | 0.11  |
| BK-750112-3000         | FM2463          | PAPER    | 2 PASS            | 38              | INT TH    | 154.7   | x | 95.0  | x         | 3.7 | 6.09 | x | 3.74 | x | 0.144 |
| G-3-8088D              | FM3721          | BRONZE   | SUN/WAG           | 66              | EXT TH    | 142.6   | x | 85.7  | x         | 2.8 | 5.61 | x | 3.37 | x | 0.11  |
| G-3-8088R              | FM4849          | PAPER    | WAFFLE            | 66              | EXT TH    | 141.3   | x | 85.5  | x         | 2.5 | 5.56 | x | 3.37 | x | 0.098 |
| G-3-8089               | FM2636MP        | STEEL    | -----             | 38              | INT TH    | 133.0   | x | 77.0  | x         | 1.5 | 5.24 | x | 3.03 | x | 0.059 |
| G-3-8089C              | FM2636MP        | STEEL    | -----             | 38              | INT TH    | 133.0   | x | 77.0  | x         | 1.5 | 5.24 | x | 3.03 | x | 0.059 |
| G-3-8135               | FM4390MP        | STEEL    | -----             | 28              | INT TH    | 75.0    | x | 42.0  | x         | 1.3 | 2.95 | x | 1.65 | x | 0.051 |
| G-3-8136               | FM4387          | BRONZE   | WAFFLE            | 8               | EXT LG    | 90.0    | x | 48.0  | x         | 2.2 | 3.54 | x | 1.89 | x | 0.087 |
| G-3-8673C              | FM6193          | BRONZE   | RADIAL            | 8               | EXT LG    | 102.9   | x | 58.0  | x         | 2.5 | 4.05 | x | 2.28 | x | 0.098 |
| G-3-8674               | FM6196MP        | STEEL    | -----             | 34              | INT TH    | 86.6    | x | 51.6  | x         | 1.2 | 3.41 | x | 2.03 | x | 0.047 |
| <b>MOROOKA</b>         |                 |          |                   |                 |           |         |   |       |           |     |      |   |      |   |       |
| 1731746                | FM6286MP        | STEEL    | -----             | 4               | EXT LG    | 86.6    | x | 60.1  | x         | 1.5 | 3.41 | x | 2.37 | x | 0.059 |
| <b>MOXY</b>            |                 |          |                   |                 |           |         |   |       |           |     |      |   |      |   |       |
| 52758                  | FM2279          | BRONZE   | SUNBURST          | 35              | EXT TH    | 177.5   | x | 109.0 | x         | 2.0 | 6.99 | x | 4.29 | x | 0.079 |
| 52772                  | FM3600MP        | STEEL    | -----             | 35              | INT TH    | 170.9   | x | 102.9 | x         | 1.5 | 6.73 | x | 4.05 | x | 0.059 |
| 152065                 | FM2279          | BRONZE   | SUNBURST          | 35              | EXT TH    | 177.5   | x | 109.0 | x         | 2.0 | 6.99 | x | 4.29 | x | 0.079 |
| 152066                 | FM3602MP        | STEEL    | -----             | 35              | INT TH    | 170.9   | x | 102.9 | x         | 2.0 | 6.73 | x | 4.05 | x | 0.079 |
| 152067                 | FM3604MP        | STEEL    | -----             | 35              | INT TH    | 170.9   | x | 102.9 | x         | 2.5 | 6.73 | x | 4.05 | x | 0.098 |
| 152068                 | FM3600MP        | STEEL    | -----             | 35              | INT TH    | 170.9   | x | 102.9 | x         | 1.5 | 6.73 | x | 4.05 | x | 0.059 |
| 152069                 | FM3602MP        | STEEL    | -----             | 35              | INT TH    | 170.9   | x | 102.9 | x         | 2.0 | 6.73 | x | 4.05 | x | 0.079 |



# Forklift Transmission Discs

---

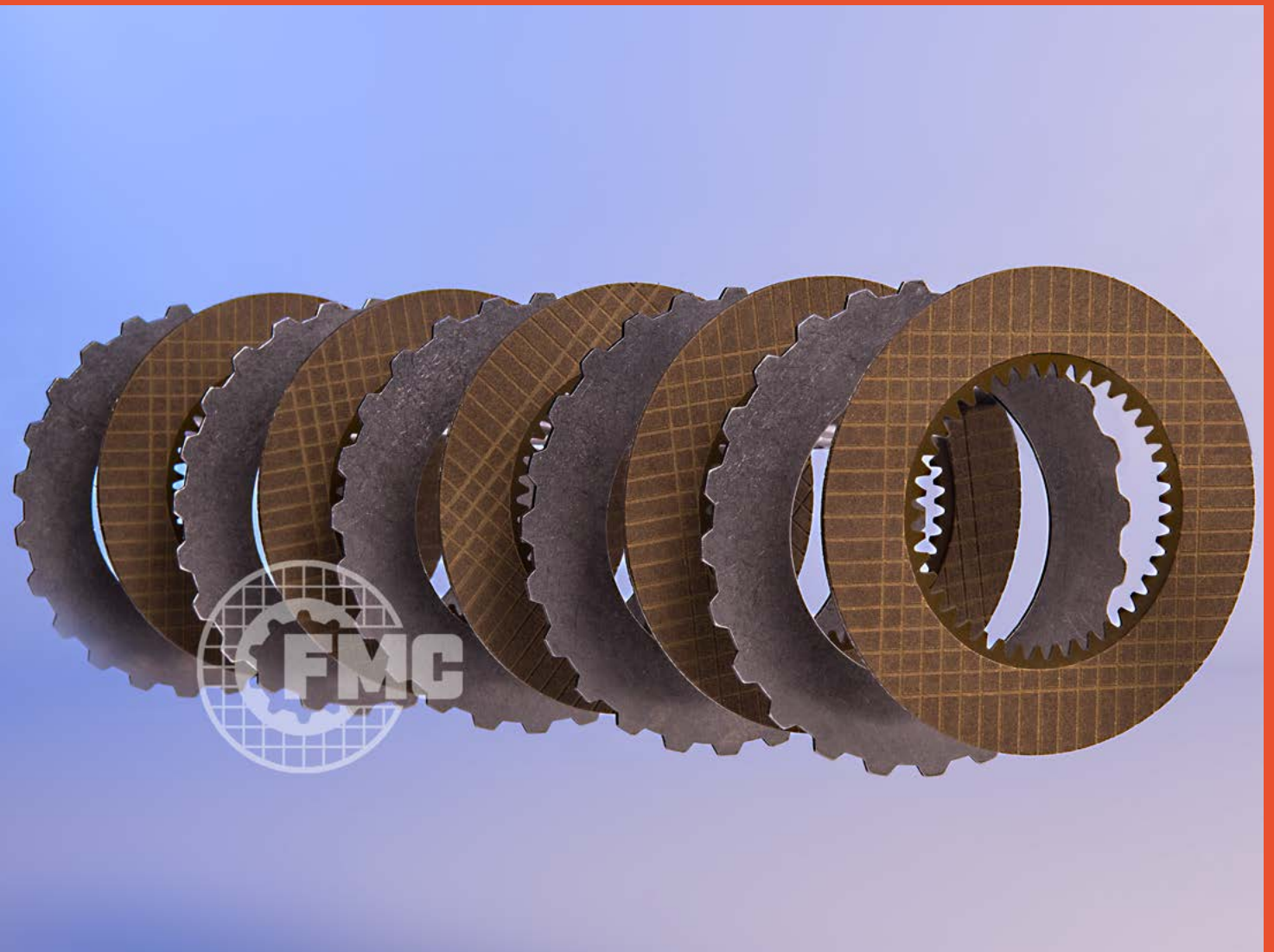

| REPLACES<br>OEM PT.NO. | FMC<br>PART NO. | MATERIAL   | GROOVE<br>DETAILS | TEETH/<br>TANGS | SIZE MM |       |   | SIZE INCH |   |     |       |   |       |   |       |
|------------------------|-----------------|------------|-------------------|-----------------|---------|-------|---|-----------|---|-----|-------|---|-------|---|-------|
| 152073                 | FM2277          | BRONZE     | SUNBURST          | 27              | EXT TH  | 137.4 | x | 90.9      | x | 2.0 | 5.41  | x | 3.58  | x | 0.079 |
| 152074                 | FM3594MP        | STEEL      | -----             | 29              | INT TH  | 131.1 | x | 85.1      | x | 2.0 | 5.16  | x | 3.35  | x | 0.079 |
| 152075                 | FM3596MP        | STEEL      | -----             | 29              | INT TH  | 131.1 | x | 85.1      | x | 2.5 | 5.16  | x | 3.35  | x | 0.098 |
| 152085                 | FM4449          | MOLYBDENUM | SPR/WAG           | 26              | INT TH  | 147.8 | x | 75.4      | x | 3.0 | 5.82  | x | 2.97  | x | 0.118 |
| 152106                 | FM3592MP        | STEEL      | -----             | 29              | INT TH  | 131.1 | x | 85.1      | x | 1.5 | 5.16  | x | 3.35  | x | 0.059 |
| 152126                 | FM2279          | BRONZE     | SUNBURST          | 35              | EXT TH  | 177.5 | x | 109.0     | x | 2.0 | 6.99  | x | 4.29  | x | 0.079 |
| 152373                 | FM2962MP        | STEEL      | -----             | 37              | INT TH  | 204.6 | x | 143.8     | x | 2.0 | 8.06  | x | 5.66  | x | 0.079 |
| 152374                 | FM2943          | BRONZE     | SPR/RAD           | 42              | EXT TH  | 212.5 | x | 154.5     | x | 2.5 | 8.37  | x | 6.08  | x | 0.098 |
| 152414                 | FM5367          | BRONZE     | SPR/RAD           | 75              | INT TH  | 373.2 | x | 295.5     | x | 3.3 | 14.69 | x | 11.63 | x | 0.128 |
| 152415                 | FM5370MP        | STEEL      | -----             | 14              | EXT SL  | 399.5 | x | 310.3     | x | 3.0 | 15.73 | x | 12.22 | x | 0.118 |
| 153415                 | FM5250-3.3      | STEEL      | HARDENED          | 4               | EXT LG  | 189.8 | x | 92.1      | x | 3.3 | 7.47  | x | 3.63  | x | 0.13  |
| 153416                 | FM5247          | MOLYBDENUM | SPR/WAG           | 40              | INT TH  | 172.0 | x | 84.1      | x | 3.0 | 6.77  | x | 3.31  | x | 0.118 |
| 252016                 | FM4000MP        | STEEL      | -----             | 12              | EXT LG  | 360.0 | x | 301.0     | x | 3.5 | 14.16 | x | 11.85 | x | 0.137 |
| 252382                 | FM4125          | BRONZE     | SUN-PLAIN         | 35              | EXT TH  | 177.5 | x | 109.0     | x | 1.6 | 6.99  | x | 4.29  | x | 0.063 |
| 252392                 | FM4123          | BRONZE     | SUN-PLAIN         | 27              | EXT TH  | 137.4 | x | 90.9      | x | 1.6 | 5.41  | x | 3.58  | x | 0.063 |
| 252535                 | FM3801          | PAPER      | RADIAL            | 30              | INT LG  | 329.0 | x | 285.0     | x | 3.0 | 12.96 | x | 11.24 | x | 0.117 |
| 352149                 | FM4282MP        | STEEL      | -----             | 45              | INT TH  | 185.0 | x | 132.7     | x | 2.5 | 7.28  | x | 5.22  | x | 0.098 |
| 352150                 | FM4284MP        | STEEL      | -----             | 45              | INT TH  | 185.0 | x | 132.7     | x | 3.0 | 7.28  | x | 5.22  | x | 0.118 |
| 352151                 | FM4286MP        | STEEL      | -----             | 45              | INT TH  | 185.0 | x | 132.7     | x | 3.5 | 7.28  | x | 5.22  | x | 0.138 |
| 352152                 | FM4288MP        | STEEL      | -----             | 45              | INT TH  | 185.0 | x | 132.7     | x | 4.0 | 7.28  | x | 5.22  | x | 0.157 |
| 352153                 | FM4280MP        | STEEL      | -----             | 45              | INT TH  | 185.0 | x | 132.7     | x | 2.0 | 7.28  | x | 5.22  | x | 0.077 |
| 352154                 | FM6781          | CARBON PA  | RADIAL            | 64              | EXT TH  | 196.0 | x | 142.0     | x | 2.6 | 7.72  | x | 5.59  | x | 0.1   |
| 352155                 | FM6783          | CARBON PA  | RADIAL/PLAIN      | 64              | EXT TH  | 196.0 | x | 142.0     | x | 2.0 | 7.72  | x | 5.59  | x | 0.079 |
| 352156                 | FM4298MP        | STEEL      | -----             | 45              | INT TH  | 170.0 | x | 132.7     | x | 2.5 | 6.69  | x | 5.22  | x | 0.098 |
| 352157                 | FM4300MP        | STEEL      | -----             | 45              | INT TH  | 170.0 | x | 132.7     | x | 3.0 | 6.69  | x | 5.22  | x | 0.118 |
| 352158                 | FM4302MP        | STEEL      | -----             | 45              | INT TH  | 170.0 | x | 132.7     | x | 3.5 | 6.69  | x | 5.22  | x | 0.138 |
| 352160                 | FM8595          | CARBON PA  | RADIAL            | 35              | EXT TH  | 176.5 | x | 142.0     | x | 2.5 | 6.95  | x | 5.51  | x | 0.096 |
| 352161                 | FM8597          | CARBON PA  | RADIAL/PLAIN      | 35              | EXT TH  | 176.5 | x | 142.0     | x | 1.9 | 6.95  | x | 5.51  | x | 0.073 |
| 507178                 | FM4304MP        | STEEL      | -----             | 45              | INT TH  | 170.0 | x | 132.7     | x | 4.0 | 6.69  | x | 5.22  | x | 0.157 |
| 508791                 | FM4296MP        | STEEL      | -----             | 45              | INT TH  | 170.0 | x | 132.7     | x | 2.0 | 6.69  | x | 5.22  | x | 0.077 |
| 508795                 | FM4289          | BRONZE     | SPR/RAD           | 35              | EXT TH  | 176.5 | x | 142.0     | x | 2.5 | 6.95  | x | 5.51  | x | 0.096 |
| 508796                 | FM4291          | BRNZ/PLN   | SPR/RAD           | 35              | EXT TH  | 176.5 | x | 142.0     | x | 2.0 | 6.95  | x | 5.51  | x | 0.077 |
| 510813                 | FM4282MP        | STEEL      | -----             | 45              | INT TH  | 185.0 | x | 132.7     | x | 2.5 | 7.28  | x | 5.22  | x | 0.098 |
| 510814                 | FM4284MP        | STEEL      | -----             | 45              | INT TH  | 185.0 | x | 132.7     | x | 3.0 | 7.28  | x | 5.22  | x | 0.118 |
| 510815                 | FM4286MP        | STEEL      | -----             | 45              | INT TH  | 185.0 | x | 132.7     | x | 3.5 | 7.28  | x | 5.22  | x | 0.138 |
| 510816                 | FM4288MP        | STEEL      | -----             | 45              | INT TH  | 185.0 | x | 132.7     | x | 4.0 | 7.28  | x | 5.22  | x | 0.157 |
| 510817                 | FM4397          | BRONZE     | SUNBURST          | 64              | EXT TH  | 196.0 | x | 142.0     | x | 2.5 | 7.72  | x | 5.59  | x | 0.096 |
| 510818                 | FM4399          | BRNZ/PLN   | SUNBURST          | 64              | EXT TH  | 196.0 | x | 142.0     | x | 2.0 | 7.72  | x | 5.59  | x | 0.077 |
| 510968                 | FM5250-3.3      | STEEL      | HARDENED          | 4               | EXT LG  | 189.8 | x | 92.1      | x | 3.3 | 7.47  | x | 3.63  | x | 0.13  |

| REPLACES<br>OEM PT.NO. | FMC<br>PART NO. | MATERIAL             | GROOVE<br>DETAILS | TEETH/<br>TANGS | SIZE MM   | SIZE INCH                                |
|------------------------|-----------------|----------------------|-------------------|-----------------|-----------|--|
| <b>NABCO</b>           |                 |                      |                   |                 |           |  |
| 2162-3-175433-01       | FM7089          | PAPER                | -----             | 57              | INT TH    | 166.0 x 137.5 x 3.0 6.54 x 5.41 x 0.118  |
| 2162-3-175434-01       | FM7092MP        | STEEL                | -----             | 6               | EXT LG    | 180.0 x 147.0 x 2.3 7.09 x 5.79 x 0.091  |
| <b>NAF</b>             |                 |                      |                   |                 |           |  |
| ?                      | FM4669          | OBSOLETE AFTER STOCK |                   | 36              | INT TH    | 169.0 x 70.0 x 4.9 6.65 x 2.76 x 0.193   |
| 7002.739               | FM7797          | GRAPHITE             | SUNBURST          | 45              | (54)IN TH | 298.0 x 106.0 x 5.0 11.73 x 4.17 x 0.197 |
| 7344.034               | FM6998MP        | STEEL                | -----             | 6               | EXT LG    | 334.0 x 225.0 x 3.0 13.15 x 8.86 x 0.118 |
| 7344.036               | FM5210MP        | STEEL                | -----             | 2               | EXT LG    | 253.0 x 150.0 x 2.6 9.96 x 5.91 x 0.102  |
| 7344.04                | FM4720MP        | STEEL                | -----             | 2               | EXT LG    | 196.0 x 110.0 x 2.5 7.72 x 4.33 x 0.098  |
| 7344.048               | FM9122MP        | STEEL                | -----             | 6               | EXT LG    | 333.5 x 225.5 x 2.5 13.13 x 8.88 x 0.098 |
| 7345.027               | FM7797          | GRAPHITE             | SUNBURST          | 45              | (54)IN TH | 298.0 x 106.0 x 5.0 11.73 x 4.17 x 0.197 |
| 7345.036               | FM8629          | GRAPHITE             | WAFFLE            | 26              | INT TH    | 223.6 x 51.3 x 4.8 8.8 x 2.02 x 0.189    |
| 7345.039               | FM8633          | GRAPHITE             | SUNBURST          | 20              | INT TH    | 169.0 x 36.0 x 4.8 6.65 x 1.42 x 0.189   |
| 7345.04                | FM4717          | GRAPHITE             | SUNBURST          | 24              | INT TH    | 169.0 x 45.1 x 4.8 6.65 x 1.78 x 0.189   |
| 7345.053               | FM7901          | GRAPHITE             | SUNBURST          | 45              | (54)IN TH | 298.0 x 106.0 x 3.9 11.73 x 4.17 x 0.152 |
| 7345.056               | FM7271          | GRAPHITE             | SUNBURST          | 54              | INT TH    | 196.0 x 105.5 x 3.2 7.72 x 4.15 x 0.126  |
| 7345.057               | FM8629          | GRAPHITE             | WAFFLE            | 26              | INT TH    | 223.6 x 51.3 x 4.8 8.8 x 2.02 x 0.189    |
| 7345.061               | FM6399          | PAPER                | WAFFLE            | 49              | (58)IN TH | 297.5 x 116.2 x 5.0 11.71 x 4.57 x 0.197 |
| 7345.069               | FM9393          | PAPER                | WAFFLE            | 45              | (54)IN TH | 298.0 x 106.2 x 5.0 11.73 x 4.18 x 0.197 |
| 7345.07                | FM9163          | GRAPHITE             | SUNBURST          | 22              | INT TH    | 169.0 x 41.1 x 4.9 6.65 x 1.62 x 0.193   |
| ?                      | FM8636MP        | STEEL                | -----             | 2               | EXT LG    | 195.6 x 110.0 x 2.7 7.7 x 4.33 x 0.106   |
| ?                      | FM8631          | BRONZE               | SUNBURST          | 24              | INT TH    | 174.8 x 45.2 x 3.0 6.88 x 1.78 x 0.118   |
| ?                      | FM8979          | CARBON PA            | WAFFLE            | 49              | (58)IN TH | 298.2 x 116.5 x 5.0 11.74 x 4.59 x 0.197 |
| <b>NEWAGE</b>          |                 |                      |                   |                 |           |  |
| 200/0750               | FM3001          | BRONZE               | SPR/WAG           | 15              | INT TH    | 152.0 x 30.1 x 4.8 5.98 x 1.18 x 0.189   |
| 200/0890               | FM3900MP        | STEEL                | -----             | 2               | EXT SL    | 167.0 x 122.0 x 2.5 6.57 x 4.8 x 0.098   |
| 215-0750               | FM6421KIT       | 2 X PISTON           | 4 X PAPER         | 4 X             | STEEL     |  |
| 215/0751               | FM5321          | PAPER                | WAFFLE            | 15              | INT TH    | 151.7 x 30.4 x 4.8 5.97 x 1.2 x 0.189    |
| 250/0750               | FM3002          | BRONZE               | SPR/WAG           | 15              | INT TH    | 178.0 x 36.0 x 4.8 7.0 x 1.42 x 0.189    |
| 250/0890               | FM4014MP        | STEEL                | -----             | 3               | EXT SL    | 202.0 x 140.0 x 2.5 7.95 x 5.51 x 0.098  |
| 400/0750               | FM3000          | BRONZE               | SPR/WAG           | 15              | INT TH    | 224.0 x 42.8 x 4.8 8.82 x 1.69 x 0.189   |
| 415-0750               | FM6423KIT       | 2 X PISTON           | 4 X PAPER         | 4 X             | STEEL     |  |
| 415/0751               | FM5323          | PAPER                | WAFFLE            | 15              | INT TH    | 178.0 x 36.4 x 4.8 7.01 x 1.43 x 0.189   |
| 615/0751               | FM5325          | PAPER                | WAFFLE            | 15              | INT TH    | 223.8 x 43.0 x 4.8 8.81 x 1.69 x 0.189   |
| 615/0891               | FM3856MP        | STEEL                | -----             | 3               | EXT SL    | 238.8 x 174.2 x 2.7 9.4 x 6.86 x 0.106   |
| 915/0751               | FM5327          | PAPER                | WAFFLE            | 15              | INT TH    | 257.8 x 47.0 x 4.8 10.15 x 1.85 x 0.189  |
| 915/0891               | FM5194MP        | STEEL                | -----             | 3               | EXT SL    | 270.0 x 206.0 x 2.6 10.63 x 8.11 x 0.102 |
| <b>NEW HOLLAND</b>     |                 |                      |                   |                 |           |  |
| 547395                 | FM6672MP        | STEEL                | -----             | 65              | INT TH    | 259.8 x 190.0 x 2.5 10.23 x 7.48 x 0.098 |
| 566519                 | FM5862MP        | STEEL                | HARD/BLACK        | 21              | INT TH    | 229.0 x 171.0 x 2.0 9.02 x 6.73 x 0.079  |
| 567386                 | FM1601          | BRONZE               | -----             | 95              | EXT TH    | 305.0 x 213.0 x 4.7 12.01 x 8.39 x 0.185 |
| 587050                 | FM1601          | BRONZE               | -----             | 95              | EXT TH    | 305.0 x 213.0 x 4.7 12.01 x 8.39 x 0.185 |
| 749868                 | FM4183          | PAPER                | WAF/WAG           | 64              | INT TH    | 345.0 x 252.1 x 4.7 13.58 x 9.93 x 0.185 |
| 2810279                | FM8978MP        | STEEL                | -----             | 6               | EXT LG    | 265.8 x 147.0 x 4.0 10.46 x 5.79 x 0.157 |

| REPLACES<br>OEM PT.NO. | FMC<br>PART NO. | MATERIAL             | GROOVE<br>DETAILS | TEETH/<br>TANGS | SIZE MM   |       |   | SIZE INCH |   |      |       |   |      |   |       |
|------------------------|-----------------|----------------------|-------------------|-----------------|-----------|-------|---|-----------|---|------|-------|---|------|---|-------|
| 2810288                | FM8975          | CARBON PA            | 4 PASS            | 32              | INT TH    | 236.0 | x | 94.1      | x | 5.5  | 9.29  | x | 3.7  | x | 0.217 |
| 4993585                | FM4119          | GRAPHITE             | SUNBURST          | 14              | INT TH    | 304.0 | x | 57.0      | x | 10.0 | 11.97 | x | 2.24 | x | 0.394 |
| 4997208                | FM3919          | GRAPHITE             | SUNBURST          | 14              | INT TH    | 261.0 | x | 50.0      | x | 10.0 | 10.28 | x | 1.97 | x | 0.394 |
| 5094585                | FM3097          | GRAPHITE             | SUN/RAD           | 22              | INT TH    | 165.0 | x | 41.0      | x | 4.8  | 6.5   | x | 1.61 | x | 0.189 |
| 5102783                | FM5901          | GRAPHITE             | SUNBURST          | 13              | INT TH    | 365.0 | x | 62.0      | x | 10.0 | 14.37 | x | 2.44 | x | 0.394 |
| 5105966                | FM6265          | GRAPHITE             | SUNBURST          | 43              | INT TH    | 228.0 | x | 125.0     | x | 3.5  | 8.98  | x | 4.92 | x | 0.138 |
| 5107223                | FM6939          | OBSOLETE             | -----             | 93              | EXT TH    | 283.3 | x | 217.5     | x | 4.5  | 11.15 | x | 8.56 | x | 0.177 |
| 5107223                | TBA             | OBSOLETE             | -----             | 93              | EXT TH    | 283.3 | x | 217.5     | x | 5.0  | 11.15 | x | 8.56 | x | 0.196 |
| 5110138                | FM6006MP        | STEEL                | -----             |                 | HOLES     | 325.0 | x | 175.0     | x | 5.0  | 12.8  | x | 6.89 | x | 0.197 |
| 5110139                | FM6942MP        | STEEL                | -----             |                 |           | 374.0 | x | 215.0     | x | 5.0  | 14.72 | x | 8.46 | x | 0.197 |
| 5111276                | TBA             | OBSOLETE             | -----             | 52              | INT TH    | 215.0 | x | 132.0     | x | 7.0  | 8.46  | x | 5.2  | x | 0.276 |
| 5111281                | FM5872MP        | STEEL                | -----             |                 | HOLES     | 445.0 | x | 240.0     | x | 7.0  | 17.52 | x | 9.45 | x | 0.276 |
| 5112343                | FM6268MP        | STEEL                | -----             | 6               | EXT LG    | 190.0 | x | 119.0     | x | 2.0  | 7.48  | x | 4.69 | x | 0.079 |
| 5112630                | FM7554MP        | STEEL                | -----             | 34              | INT TH    | 168.0 | x | 98.0      | x | 7.0  | 6.61  | x | 3.86 | x | 0.276 |
| 5113236                | FM5388MP        | STEEL                | -----             | 53              | EXT TH    | 173.0 | x | 119.0     | x | 2.0  | 6.81  | x | 4.69 | x | 0.079 |
| 5118101                | FM7230MP        | OBSOLETE             | -----             | 21              | INT TH    | 111.0 | x | 52.0      | x | 4.0  | 4.37  | x | 2.05 | x | 0.157 |
| 5119327                | FM3356MP        | STEEL                | -----             | 1               | EXT LG    | 172.0 | x | 94.0      | x | 2.7  | 6.77  | x | 3.7  | x | 0.104 |
| 5119329                | FM3289          | GRAPHITE             | SUNBURST          | 22              | INT TH    | 165.0 | x | 41.0      | x | 4.8  | 6.5   | x | 1.61 | x | 0.189 |
| 5121103                | FM6270MP        | OBSOLETE AFTER STOCK |                   | 35              | (71)EX TH | 201.0 | x | 120.0     | x | 1.5  | 7.91  | x | 4.72 | x | 0.059 |
| 5123165                | FM3289          | GRAPHITE             | SUNBURST          | 22              | INT TH    | 165.0 | x | 41.0      | x | 4.8  | 6.5   | x | 1.61 | x | 0.189 |
| 5132278                | FM6272MP        | STEEL                | HARDENED          | 38              | (76)EX TH | 176.0 | x | 92.0      | x | 1.5  | 6.93  | x | 3.62 | x | 0.059 |
| 5132279                | FM6272MP        | STEEL                | HARDENED          | 38              | (76)EX TH | 176.0 | x | 92.0      | x | 1.5  | 6.93  | x | 3.62 | x | 0.059 |
| 5132309                | FM6274MP        | STEEL                | -----             | 38              | (76)EX TH | 176.0 | x | 124.0     | x | 3.2  | 6.93  | x | 4.88 | x | 0.126 |
| 5137544                | FM1324MP        | STEEL                | -----             | 54              | EXT TH    | 139.2 | x | 98.6      | x | 1.8  | 5.48  | x | 3.88 | x | 0.07  |
| 5140243                | FM6275          | GRAPHITE             | SUNBURST          | 32              | INT TH    | 140.0 | x | 91.0      | x | 2.4  | 5.51  | x | 3.58 | x | 0.094 |
| 5140244                | FM8068MP        | STEEL                | HARDENED          | 6               | EXT LG    | 152.0 | x | 100.0     | x | 1.5  | 5.98  | x | 3.94 | x | 0.059 |
| 5143721                | FM6278MP        | STEEL                | -----             | 50              | EXT TH    | 153.0 | x | 99.0      | x | 1.5  | 6.02  | x | 3.9  | x | 0.059 |
| 5146036                | TBA             | OBSOLETE             | -----             | 34              | INT TH    | 180.0 | x | 98.0      | x | 6.0  | 7.09  | x | 3.86 | x | 0.236 |
| 5146315                | FM7808MP        | STEEL                | -----             | 52              | INT TH    | 215.0 | x | 132.0     | x | 5.0  | 8.46  | x | 5.2  | x | 0.197 |
| 5146478                | FM6280MP        | OBSOLETE             | -----             | 100             | EXT TH    | 199.0 | x | 92.0      | x | 1.5  | 7.83  | x | 3.62 | x | 0.059 |
| 5154521                | FM4371          | GRAPHITE             | SUNBURST          | 14              | INT TH    | 327.0 | x | 60.0      | x | 10.0 | 12.87 | x | 2.36 | x | 0.394 |
| 5154521                | FM5161          | PAPER                | 3 PASS            | 14              | INT TH    | 327.0 | x | 60.0      | x | 10.0 | 12.87 | x | 2.36 | x | 0.394 |
| 5154760                | FM5769          | PAPER                | WAFFLE            | 44              | INT TH    | 158.7 | x | 111.9     | x | 2.8  | 6.25  | x | 4.41 | x | 0.11  |
| 5154761                | FM5769          | PAPER                | WAFFLE            | 44              | INT TH    | 158.7 | x | 111.9     | x | 2.8  | 6.25  | x | 4.41 | x | 0.11  |
| 5158120                | FM6559          | PAPER                | WAFFLE            |                 | PAD       |       |   |           |   |      |       |   |      |   |       |
| 5158123                | FM6561          | PAPER                | WAFFLE            |                 | PAD       |       |   |           |   |      |       |   |      |   |       |
| 5158919                | FM4353          | PAPER                | WAFFLE            | 32              | INT TH    | 140.0 | x | 91.0      | x | 2.4  | 5.51  | x | 3.58 | x | 0.094 |
| 5159755                | FM6257          | PAPER                | WAFFLE            | 32              | INT TH    | 140.0 | x | 91.0      | x | 1.8  | 5.51  | x | 3.58 | x | 0.071 |
| 5159830                | FM3097          | GRAPHITE             | SUN/RAD           | 22              | INT TH    | 165.0 | x | 41.0      | x | 4.8  | 6.5   | x | 1.61 | x | 0.189 |
| 5161904                | FM6260MP        | STEEL                | -----             | 62              | INT TH    | 254.0 | x | 194.0     | x | 2.0  | 10    | x | 7.64 | x | 0.079 |
| 5161932                | FM6261          | OBSOLETE             | SUNBURST          | 29              | INT TH    | 224.0 | x | 78.0      | x | 4.9  | 8.82  | x | 3.07 | x | 0.193 |
| 5162231                | FM1216MP        | STEEL                | -----             | 60              | EXT TH    | 154.2 | x | 113.8     | x | 1.8  | 6.07  | x | 4.48 | x | 0.07  |
| 5163379                | FM6263          | OBSOLETE             | WAFFLE            | 87              | EXT TH    | 264.0 | x | 206.0     | x | 3.6  | 10.39 | x | 8.11 | x | 0.142 |
| 5163734                | FM7726MP        | STEEL                | -----             | 1               | EXT SL    | 228.6 | x | 150.0     | x | 2.6  | 9     | x | 5.91 | x | 0.102 |
| 5163840                | FM8068MP        | STEEL                | HARDENED          | 6               | EXT LG    | 152.0 | x | 100.0     | x | 1.5  | 5.98  | x | 3.94 | x | 0.059 |
| 5163844                | FM3491          | PAPER                | WAFFLE            | 32              | INT TH    | 140.0 | x | 91.0      | x | 1.7  | 5.51  | x | 3.58 | x | 0.067 |
| 5163904                | FM3491          | PAPER                | WAFFLE            | 32              | INT TH    | 140.0 | x | 91.0      | x | 1.7  | 5.51  | x | 3.58 | x | 0.067 |

| REPLACES<br>OEM PT.NO. | FMC<br>PART NO. | MATERIAL    | GROOVE<br>DETAILS | TEETH/<br>TANGS | SIZE MM   |       |   |       | SIZE INCH |      |       |   |       |   |       |
|------------------------|-----------------|-------------|-------------------|-----------------|-----------|-------|---|-------|-----------|------|-------|---|-------|---|-------|
| 5164930                | FM9311          | PAPER       | WAFFLE            | 52              | INT TH    | 148.6 | x | 107.7 | x         | 2.8  | 5.85  | x | 4.24  | x | 0.108 |
| 5165058                | FM8831KIT       | KIT         |                   |                 |           |       |   |       |           |      |       |   |       |   |       |
| 5165061                | FM9314MP        | STEEL       | -----             | 60              | EXT TH    | 154.2 | x | 113.8 | x         | 1.5  | 6.07  | x | 4.48  | x | 0.059 |
| 5165954                | FM1324MP        | STEEL       | -----             | 54              | EXT TH    | 139.2 | x | 98.6  | x         | 1.8  | 5.48  | x | 3.88  | x | 0.07  |
| 5167863                | FM8829KIT       | KIT         |                   |                 |           |       |   |       |           |      |       |   |       |   |       |
| 5167875                | FM7829KIT       | KIT         |                   |                 |           |       |   |       |           |      |       |   |       |   |       |
| 5184313                | FM5869          | PAPER       | 3 PASS            | 14              | INT TH    | 261.0 | x | 50.0  | x         | 9.6  | 10.28 | x | 1.97  | x | 0.378 |
| 5187222                | FM3658MP        | STEEL       | -----             | 54              | EXT TH    | 139.0 | x | 99.0  | x         | 2.0  | 5.47  | x | 3.9   | x | 0.079 |
| 5191497                | FM7781          | GRAPHITE    | SUNBURST          | 12              | INT TH    | 327.0 | x | 53.0  | x         | 10.0 | 12.87 | x | 2.09  | x | 0.393 |
| 5199724                | FM6556MP        | STEEL       | -----             | 32              | EXT TH    | 168.0 | x | 130.0 | x         | 2.0  | 6.61  | x | 5.12  | x | 0.079 |
| 5213636                | FM3602MP        | STEEL       | -----             | 35              | INT TH    | 170.9 | x | 102.9 | x         | 2.0  | 6.73  | x | 4.05  | x | 0.079 |
| 6914431                | FM2971          | BRONZE      | WAFFLE            | 22              | INT TH    | 71.7  | x | 44.0  | x         | 2.8  | 2.82  | x | 1.73  | x | 0.11  |
| 6914432                | FM3474MP        | STEEL       | -----             | 4               | EXT LG    | 85.0  | x | 49.2  | x         | 1.5  | 3.35  | x | 1.94  | x | 0.059 |
| 6914433                | FM2969          | BRONZE      | WAFFLE            | 22              | INT TH    | 71.7  | x | 44.0  | x         | 1.6  | 2.82  | x | 1.73  | x | 0.063 |
| 6914479                | FM2777          | GRAPHITE    | SUNBURST          | 27              | INT TH    | 260.0 | x | 66.1  | x         | 10.0 | 10.24 | x | 2.6   | x | 0.394 |
| 7380530                | FM4451          | MOLYBDENUM  | SPR/WAG           | 46              | (50)IN TH | 117.5 | x | 62.6  | x         | 2.6  | 4.63  | x | 2.46  | x | 0.102 |
| 8015306                | FM9042MP        | STEEL       | HARDENED          | 8               | EXT LG    | 160.0 | x | 109.5 | x         | 4.0  | 6.3   | x | 4.31  | x | 0.157 |
| 8603203                | FM4449          | MOLYBDENUM  | SPR/WAG           | 26              | INT TH    | 147.8 | x | 75.4  | x         | 3.0  | 5.82  | x | 2.97  | x | 0.118 |
| 8603272                | FM4451          | MOLYBDENUM  | SPR/WAG           | 46              | (50)IN TH | 117.5 | x | 62.6  | x         | 2.6  | 4.63  | x | 2.46  | x | 0.102 |
| 8603277                | FM4666-2.2      | STEEL       | HARDENED          | 6               | EXT SL    | 130.0 | x | 66.8  | x         | 2.2  | 5.12  | x | 2.63  | x | 0.087 |
| 8603278                | FM4666MP        | STEEL       | HARDENED          | 6               | EXT SL    | 130.0 | x | 66.8  | x         | 2.3  | 5.12  | x | 2.63  | x | 0.091 |
| 8603279                | FM4666-2.4      | STEEL       | HARDENED          | 6               | EXT SL    | 130.0 | x | 66.8  | x         | 2.4  | 5.12  | x | 2.63  | x | 0.094 |
| 8603280                | FM4666-2.5      | STEEL       | HARDENED          | 6               | EXT SL    | 130.0 | x | 66.8  | x         | 2.5  | 5.12  | x | 2.63  | x | 0.098 |
| 8603411                | FM4789          | PAPER/PLAIN | RADIAL            | 44              | EXT TH    | 158.8 | x | 111.5 | x         | 1.9  | 6.25  | x | 4.39  | x | 0.075 |
| 8603412                | FM4787          | CARBON PA   | RADIAL            | 44              | EXT TH    | 158.8 | x | 111.5 | x         | 2.5  | 6.25  | x | 4.39  | x | 0.098 |
| 8603413                | FM4790MP        | STEEL       | -----             | 42              | INT TH    | 150.9 | x | 102.5 | x         | 2.5  | 5.94  | x | 4.04  | x | 0.098 |
| 8603486                | FM4786MP        | STEEL       | -----             | 42              | INT TH    | 167.8 | x | 102.5 | x         | 2.5  | 6.61  | x | 4.04  | x | 0.098 |
| 8603581                | FM4183          | PAPER       | WAF/WAG           | 64              | INT TH    | 345.0 | x | 252.1 | x         | 4.7  | 13.58 | x | 9.93  | x | 0.185 |
| 8603582                | FM4186MP        | STEEL       | -----             | 20              | EXT LG    | 372.5 | x | 262.5 | x         | 4.0  | 14.67 | x | 10.33 | x | 0.157 |
| 8603592                | FM7126-2.9      | STEEL       | HARDENED          | 4               | EXT LG    | 164.8 | x | 82.4  | x         | 2.9  | 6.49  | x | 4.24  | x | 0.114 |
| 8605403                | FM8595          | CARBON PA   | RADIAL            | 35              | EXT TH    | 176.5 | x | 142.0 | x         | 2.5  | 6.95  | x | 5.51  | x | 0.096 |
| 9564850                | FM3586MP        | STEEL       | -----             | 12              | EXT LG    | 320.0 | x | 268.0 | x         | 2.5  | 12.6  | x | 10.55 | x | 0.098 |
| 9564851                | FM3594MP        | STEEL       | -----             | 29              | INT TH    | 131.1 | x | 85.1  | x         | 2.0  | 5.16  | x | 3.35  | x | 0.079 |
| 9564887                | FM2277          | BRONZE      | SUNBURST          | 27              | EXT TH    | 137.4 | x | 90.9  | x         | 2.0  | 5.41  | x | 3.58  | x | 0.079 |
| 9564888                | FM2279          | BRONZE      | SUNBURST          | 35              | EXT TH    | 177.5 | x | 109.0 | x         | 2.0  | 6.99  | x | 4.29  | x | 0.079 |
| 9564934                | FM3575          | PAPER       | 3 PASS            | 35              | INT TH    | 179.0 | x | 103.0 | x         | 3.5  | 7.05  | x | 4.05  | x | 0.138 |
| 9567332                | FM3604MP        | STEEL       | -----             | 35              | INT TH    | 170.9 | x | 102.9 | x         | 2.5  | 6.73  | x | 4.05  | x | 0.098 |
| 9571353                | FM4647          | BRONZE      | SPR/RAD           | 34              | INT TH    | 100.0 | x | 68.2  | x         | 1.6  | 3.94  | x | 2.69  | x | 0.061 |
| 9571354                | FM4933          | BRONZE      | WAF/WAG           | 45              | INT TH    | 187.0 | x | 132.6 | x         | 3.0  | 7.36  | x | 5.22  | x | 0.118 |
| 9571369                | FM3592MP        | STEEL       | -----             | 29              | INT TH    | 131.1 | x | 85.1  | x         | 1.5  | 5.16  | x | 3.35  | x | 0.059 |
| 9580400                | FM3602MP        | STEEL       | -----             | 35              | INT TH    | 170.9 | x | 102.9 | x         | 2.0  | 6.73  | x | 4.05  | x | 0.079 |
| 9580526                | FM2279          | BRONZE      | SUNBURST          | 35              | EXT TH    | 177.5 | x | 109.0 | x         | 2.0  | 6.99  | x | 4.29  | x | 0.079 |
| 9581438                | FM4123          | BRONZE      | SUN-PLAIN         | 27              | EXT TH    | 137.4 | x | 90.9  | x         | 1.6  | 5.41  | x | 3.58  | x | 0.063 |
| 9582361                | FM4125          | BRONZE      | SUN-PLAIN         | 35              | EXT TH    | 177.5 | x | 109.0 | x         | 1.6  | 6.99  | x | 4.29  | x | 0.063 |
| 9596286                | FM3614MP        | STEEL       | -----             | 91              | EXT TH    | 355.0 | x | 217.0 | x         | 5.5  | 13.98 | x | 8.54  | x | 0.217 |
| 9601625                | FM4650MP        | STEEL       | -----             | 24              | EXT TH    | 108.2 | x | 76.2  | x         | 1.2  | 4.26  | x | 3.0   | x | 0.045 |
| 9606003                | FM4089          | PAPER       | 3 PASS            | 48              | INT TH    | 232.7 | x | 142.0 | x         | 4.0  | 9.16  | x | 5.59  | x | 0.157 |

| REPLACES<br>OEM PT.NO. | FMC<br>PART NO. | MATERIAL             | GROOVE<br>DETAILS | TEETH/<br>TANGS | SIZE MM    | SIZE INCH                                 |
|------------------------|-----------------|----------------------|-------------------|-----------------|------------|---|
| 9609500                | FM4686MP        | STEEL                | -----             | 81              | EXT TH     | 243.6 x 152.1 x 2.5 9.59 x 5.99 x 0.098   |
| 9609501                | FM6120-3.0      | STEEL                | -----             | 81              | EXT TH     | 243.5 x 153.0 x 3.0 9.59 x 6.02 x 0.118   |
| 9609502                | FM6896MP        | STEEL                | -----             | 81              | EXT TH     | 243.6 x 152.1 x 2.0 9.59 x 5.99 x 0.079   |
| 9613190                | FM2815          | PAPER                | 4 PASS            | 42              | INT TH     | 340.0 x 206.0 x 5.5 13.39 x 8.11 x 0.217  |
| 9648797                | FM4785          | PAPER/PLAIN          | RADIAL            | 34              | EXT TH     | 177.4 x 111.5 x 1.9 6.98 x 4.39 x 0.075   |
| 9648798                | FM4783          | CARBON PA            | RADIAL            | 34              | EXT TH     | 177.4 x 111.5 x 2.5 6.98 x 4.39 x 0.098   |
| 9671205                | FM4183          | PAPER                | WAF/WAG           | 64              | INT TH     | 345.0 x 252.1 x 4.7 13.58 x 9.93 x 0.185  |
| 9687959                | FM7126-2.9      | STEEL                | HARDENED          | 4               | EXT LG     | 164.8 x 82.4 x 2.9 6.49 x 4.24 x 0.114    |
| 9688127                | FM4787          | CARBON PA            | RADIAL            | 44              | EXT TH     | 158.8 x 111.5 x 2.5 6.25 x 4.39 x 0.098   |
| 9710562                | FM5572MP        | STEEL                | -----             | 20              | EXT LG     | 372.5 x 262.5 x 2.0 14.67 x 10.33 x 0.079 |
| 9823447                | OBSOLETE        | GRAPHITE             | -----             | 23              | INT TH     | 368.0 x 79.0 x 9.6 14.49 x 3.11 x 0.376   |
| 9823827                | FM3698MP        | STEEL                | -----             | 60              | EXT TH     | 154.2 x 113.8 x 2.6 6.07 x 4.48 x 0.1     |
| 9843824                | FM4647          | BRONZE               | SPR/RAD           | 34              | INT TH     | 100.0 x 68.2 x 1.6 3.94 x 2.69 x 0.061    |
| 9845268                | FM1381OE        | BRONZE               | RADIAL            | 52              | INT TH     | 148.6 x 107.7 x 2.9 5.85 x 4.24 x 0.114   |
| 9966308                | FM2971          | BRONZE               | WAFFLE            | 22              | INT TH     | 71.7 x 44.0 x 2.8 2.82 x 1.73 x 0.11      |
| 9966309                | FM3474MP        | STEEL                | -----             | 4               | EXT LG     | 85.0 x 49.2 x 1.5 3.35 x 1.94 x 0.059     |
| 9966310                | FM2969          | BRONZE               | WAFFLE            | 22              | INT TH     | 71.7 x 44.0 x 1.6 2.82 x 1.73 x 0.063     |
| 9968289                | FM3264MP        | STEEL                | -----             | 26              | EXT TH     | 143.5 x 89.5 x 2.2 5.65 x 3.52 x 0.084    |
| 9968290                | FM3261          | PAPER                | 2 PASS            | 40              | INT TH     | 127.1 x 82.2 x 2.5 5.0 x 3.24 x 0.98      |
| 9970713                | FM5201          | PAPER                | WAFFLE            | 22              | INT TH     | 165.0 x 41.0 x 4.7 6.5 x 1.61 x 0.185     |
| 44011292               | FM6251          | OBSOLETE AFTER STOCK |                   | 26              | INT TH     | 280.0 x 64.0 x 5.0 11.02 x 2.52 x 0.197   |
| 44011293               | FM6254MP        | STEEL                | -----             |                 | EXT LGS    | 286.0 x 110.0 x 3.0 11.26 x 4.33 x 0.118  |
| 44019288               | FM6256MP        | STEEL                | -----             | 34              | INT TH     | 168.0 x 98.0 x 3.0 6.61 x 3.86 x 0.118    |
| 47106252               | FM8483          | GRAPHITE             | SUN/RAD           | 28              | INT TH     | 242.6 x 56.1 x 4.8 9.55 x 2.21 x 0.189    |
| 47106254               | FM7274MP        | STEEL                | -----             | 2               | EXT LG     | 288.0 x 156.0 x 3.0 11.34 x 6.14 x 0.118  |
| 47123297               | FM3035          | PAPER                | WAFFLE            | 22              | INT TH     | 204.5 x 53.3 x 4.8 8.05 x 2.1 x 0.189     |
| 47126358               | FM7899          | PAPER                | WAFFLE            | 14              | INT TH     | 326.7 x 60.2 x 9.6 12.86 x 2.37 x 0.378   |
| 47126359               | FM5161          | PAPER                | 3 PASS            | 14              | INT TH     | 327.0 x 60.0 x 10.0 12.87 x 2.36 x 0.394  |
| 47136624 KIT           | FM9437          | PAPER                | WAFFLE            | 63              | INT TH     | 154.3 x 124.6 x 2.4 6.07 x 4.91 x 0.094   |
| 47136624 KIT           | FM9440MP        | STEEL                | -----             | 56              | EXT TH     | 167.0 x 130.2 x 2.2 6.57 x 5.13 x 0.087   |
| 71100503               | FM6116MP        | STEEL                | -----             | 35              | INT TH     | 129.6 x 84.8 x 2.5 5.1 x 3.34 x 0.098     |
| 71102762               | FM4625          | PAPER                | SUNBURST          | 16              | INT TH     | 201.0 x 40.5 x 4.9 7.91 x 1.59 x 0.192    |
| 71482511               | FM4625          | PAPER                | SUNBURST          | 16              | INT TH     | 201.0 x 40.5 x 4.9 7.91 x 1.59 x 0.192    |
| 75285967               | FM2279          | BRONZE               | SUNBURST          | 35              | EXT TH     | 177.5 x 109.0 x 2.0 6.99 x 4.29 x 0.079   |
| 75287708               | FM3813          | TAN PAPER            | 2 PASS            | 50              | (52) IN TH | 148.6 x 107.7 x 2.7 5.85 x 4.24 x 0.108   |
| 75287709               | FM1216MP        | STEEL                | -----             | 60              | EXT TH     | 154.2 x 113.8 x 1.8 6.07 x 4.48 x 0.07    |
| 75288736               | FM5588MP        | STEEL                | -----             | 6               | EXT LG     | 266.0 x 163.0 x 4.0 10.47 x 6.42 x 0.157  |
| 75311443               | FM4785          | PAPER/PLAIN          | RADIAL            | 34              | EXT TH     | 177.4 x 111.5 x 1.9 6.98 x 4.39 x 0.075   |
| 75311444               | FM4783          | CARBON PA            | RADIAL            | 34              | EXT TH     | 177.4 x 111.5 x 2.5 6.98 x 4.39 x 0.098   |
| 75311475               | FM4789          | PAPER/PLAIN          | RADIAL            | 44              | EXT TH     | 158.8 x 111.5 x 1.9 6.25 x 4.39 x 0.075   |
| 75311476               | FM4787          | CARBON PA            | RADIAL            | 44              | EXT TH     | 158.8 x 111.5 x 2.5 6.25 x 4.39 x 0.098   |
| 75311816               | FM6111          | CARBON PA            | RADIAL            | 27              | EXT TH     | 137.0 x 93.7 x 2.5 5.39 x 3.69 x 0.098    |
| 75311817               | FM6113          | PAPER/PLAIN          | RADIAL            | 27              | EXT TH     | 137.0 x 93.7 x 1.9 5.39 x 3.69 x 0.073    |
| 75312375               | FM7617          | PAPER                | WAFFLE            | 14              | INT TH     | 245.6 x 58.3 x 4.5 9.67 x 2.3 x 0.177     |
| 75312847               | FM1216MP        | STEEL                | -----             | 60              | EXT TH     | 154.2 x 113.8 x 1.8 6.07 x 4.48 x 0.07    |
| 76043194               | FM4375          | PAPER                | WAFFLE            | 33              | INT TH     | 400.0 x 122.5 x 6.2 15.75 x 4.82 x 0.244  |
| 76081024               | FM4783          | CARBON PA            | RADIAL            | 34              | EXT TH     | 177.4 x 111.5 x 2.5 6.98 x 4.39 x 0.098   |
| 76087703               | FM4378MP        | STEEL                | -----             | 8               | EXT LG     | 418.6 x 312.0 x 5.0 16.48 x 12.28 x 0.197 |

| REPLACES<br>OEM PT.NO. | FMC<br>PART NO. | MATERIAL   | GROOVE<br>DETAILS | TEETH/<br>TANGS | SIZE MM   | SIZE INCH                                  |
|------------------------|-----------------|------------|-------------------|-----------------|-----------|--|
| 76087704               | FM4380MP        | STEEL      | -----             | 8               | EXT LG    | 418.6 x 312.0 x 10.0 16.48 x 12.28 x 0.394 |
| 79039484               | FM1635          | BRONZE     | SPR/WAG           | 64              | INT TH    | 355.6 x 200.2 x 7.1 14.0 x 7.88 x 0.28     |
| 79042697               | FM4615          | PAPER      | 2 PASS            | 34              | INT TH    | 130.0 x 85.0 x 2.5 5.12 x 3.35 x 0.098     |
| 79042698               | FM4220MP        | STEEL      | -----             | 35              | EXT TH    | 138.6 x 90.5 x 1.6 5.46 x 3.56 x 0.063     |
| 81565601               | FM1216MP        | STEEL      | -----             | 60              | EXT TH    | 154.2 x 113.8 x 1.8 6.07 x 4.48 x 0.07     |
| 81801897               | FM1657B         | BRONZE     | SPR/RAD           | 45              | INT TH    | 133.4 x 92.7 x 2.1 5.25 x 3.65 x 0.082     |
| 81802479               | FM1705          | BRONZE     | SPR/WAG           | 22              | INT TH    | 204.5 x 53.3 x 4.8 8.05 x 2.1 x 0.19       |
| 81802535               | FM1190MP        | STEEL      | -----             | 1               | EXT LG    | 228.6 x 127.0 x 2.6 9.0 x 5.0 x 0.102      |
| 81802536               | FM1202MP        | STEEL      | -----             | 1               | EXT LG    | 209.3 x 114.3 x 2.7 8.24 x 4.5 x 0.106     |
| 81804831               | FM1359          | BRONZE     | SPIRAL            | 45              | INT TH    | 133.1 x 92.7 x 1.6 5.24 x 3.65 x 0.063     |
| 81804832               | FM1593          | BRONZE     | SUNBURST          | 52              | INT TH    | 148.6 x 107.4 x 2.3 5.85 x 4.23 x 0.09     |
| 81805123               | FM3696MP        | STEEL      | -----             | 60              | EXT TH    | 154.2 x 113.8 x 2.2 6.07 x 4.48 x 0.087    |
| 81808604               | FM1276MP        | STEEL      | DISHED            | 50              | (54)EX TH | 138.9 x 98.0 x 1.8 5.47 x 3.86 x 0.07      |
| 81808607               | FM1216MP        | STEEL      | -----             | 60              | EXT TH    | 154.2 x 113.8 x 1.8 6.07 x 4.48 x 0.07     |
| 81816970               | FM1657B         | BRONZE     | SPR/RAD           | 45              | INT TH    | 133.4 x 92.7 x 2.1 5.25 x 3.65 x 0.082     |
| 81818854               | FM1591          | BRONZE     | SPR/WAG           | 22              | INT TH    | 224.0 x 53.3 x 4.8 8.82 x 2.1 x 0.19       |
| 81822308               | FM1593          | BRONZE     | SUNBURST          | 52              | INT TH    | 148.6 x 107.4 x 2.3 5.85 x 4.23 x 0.09     |
| 81824512               | FM4564MP        | STEEL      | -----             | 15              | EXT LG    | 239.4 x 190.5 x 3.0 9.43 x 7.5 x 0.118     |
| 81824527               | FM4006MP        | STEEL      | -----             | 15              | EXT LG    | 248.8 x 218.4 x 2.0 9.8 x 8.6 x 0.08       |
| 81824528               | FM4004MP        | STEEL      | -----             | 15              | EXT LG    | 248.8 x 190.5 x 2.5 9.8 x 7.5 x 0.098      |
| 81825844               | FM1593          | BRONZE     | SUNBURST          | 52              | INT TH    | 148.6 x 107.4 x 2.3 5.85 x 4.23 x 0.09     |
| 81830026               | FM1593          | BRONZE     | SUNBURST          | 52              | INT TH    | 148.6 x 107.4 x 2.3 5.85 x 4.23 x 0.09     |
| 81833734               | FM4077          | BRONZE     | SUNBURST          | 80              | INT TH    | 229.1 x 168.4 x 2.0 9.02 x 6.63 x 0.079    |
| 81864400               | FM8168MP        | STEEL      | -----             | 34              | EXT TH    | 153.9 x 119.8 x 1.8 6.06 x 4.72 x 0.071    |
| 81865601               | FM1216MP        | STEEL      | -----             | 60              | EXT TH    | 154.2 x 113.8 x 1.8 6.07 x 4.48 x 0.07     |
| 81866377               | FM8165          | PAPER      | 1 PASS            | 63              | INT TH    | 143.4 x 115.2 x 1.7 5.65 x 4.54 x 0.068    |
| 81866478               | FM2954MP        | STEEL      | -----             | 4               | EXT LG    | 228.5 x 147.0 x 2.7 9.0 x 5.79 x 0.106     |
| 81870755               | FM1593          | BRONZE     | SUNBURST          | 52              | INT TH    | 148.6 x 107.4 x 2.3 5.85 x 4.23 x 0.09     |
| 81874478               | FM2640MP        | STEEL      | -----             | 1               | EXT SL    | 209.2 x 124.0 x 4.5 8.24 x 4.88 x 0.177    |
| 81879076               | FM3214MP        | STEEL      | -----             | 66              | EXT TH    | 168.0 x 119.0 x 1.8 6.61 x 4.69 x 0.069    |
| 82001251               | FM4555          | PAPER      | 2 PASS            | 63              | INT TH    | 155.0 x 115.0 x 2.3 6.1 x 4.53 x 0.089     |
| 82001345               | FM3212MP        | STEEL      | -----             | 66              | EXT TH    | 168.0 x 119.0 x 2.0 6.61 x 4.69 x 0.079    |
| 82002188               | FM6556MP        | STEEL      | -----             | 32              | EXT TH    | 168.0 x 130.0 x 2.0 6.61 x 5.12 x 0.079    |
| 82002190               | FM7672MP        | STEEL      | -----             | 32              | EXT TH    | 168.0 x 130.0 x 2.2 6.61 x 5.12 x 0.087    |
| 82014455               | FM1204MP        | STEEL      | -----             | 1               | EXT LG    | 228.6 x 127.0 x 2.7 9.0 x 5.0 x 0.106      |
| 83902572               | FM4007          | GRAPHITE   | SUNBURST          | 17              | INT TH    | 368.0 x 79.0 x 9.6 14.49 x 3.11 x 0.376    |
| 83908952               | FM2215          | BRONZE     | SPR/WAG           | 22              | INT TH    | 204.5 x 53.3 x 4.8 8.05 x 2.1 x 0.19       |
| 83917372               | FM4613          | GRAPHITE   | SUNBURST          | 52              | INT TH    | 148.6 x 107.4 x 2.3 5.85 x 4.23 x 0.09     |
| 83918314               | FM1324MP        | STEEL      | -----             | 54              | EXT TH    | 139.2 x 98.6 x 1.8 5.48 x 3.88 x 0.07      |
| 83919119               | FM3819          | BRONZE     | SPIRAL            | 45              | INT TH    | 133.1 x 92.7 x 2.4 5.24 x 3.65 x 0.096     |
| 83924789               | FM1657B         | BRONZE     | SPR/RAD           | 45              | INT TH    | 133.4 x 93.0 x 2.1 5.25 x 3.66 x 0.083     |
| 83925696               | FM1381OE        | BRONZE     | RADIAL            | 52              | INT TH    | 148.6 x 107.7 x 2.9 5.85 x 4.24 x 0.114    |
| 83927551               | FM4066MP        | STEEL      | -----             | 32              | INT TH    | 131.5 x 64.0 x 1.5 5.18 x 2.52 x 0.058     |
| 83930407               | FM2971          | BRONZE     | WAFFLE            | 22              | INT TH    | 71.7 x 44.0 x 2.8 2.82 x 1.73 x 0.11       |
| 83930408               | FM3474MP        | STEEL      | -----             | 4               | EXT LG    | 85.0 x 49.2 x 1.5 3.35 x 1.94 x 0.059      |
| 83930409               | FM2969          | BRONZE     | WAFFLE            | 22              | INT TH    | 71.7 x 44.0 x 1.6 2.82 x 1.73 x 0.063      |
| 83933808               | FM8999          | MOLYBDENUM | -----             | 36              | INT TH    | 71.7 x 44.8 x 1.5 2.82 x 1.76 x 0.059      |



| REPLACES<br>OEM PT.NO. | FMC<br>PART NO. | MATERIAL  | GROOVE<br>DETAILS | TEETH/<br>TANGS | SIZE MM    | SIZE INCH                               |
|------------------------|-----------------|-----------|-------------------|-----------------|------------|---|
| 83934201               | FM3602MP        | STEEL     | -----             | 35              | INT TH     | 170.9 x 102.9 x 2.0 6.73 x 4.05 x 0.079 |
| 83945586               | FM2277          | BRONZE    | SUNBURST          | 27              | EXT TH     | 137.4 x 90.9 x 2.0 5.41 x 3.58 x 0.079  |
| 83947188               | FM4001          | BRONZE    | WAF/RAD           | 80              | INT TH     | 229.1 x 168.4 x 4.5 9.02 x 6.63 x 0.177 |
| 83955538               | FM1202MP        | STEEL     | -----             | 1               | EXT LG     | 209.3 x 114.3 x 2.7 8.24 x 4.5 x 0.106  |
| 83956598               | FM2372MP        | STEEL     | -----             | 1               | EXT LG     | 228.6 x 146.1 x 2.6 9.0 x 5.75 x 0.102  |
| 83956599               | FM2217          | BRONZE    | SPR/WAG           | 22              | INT TH     | 224.0 x 53.3 x 4.8 8.82 x 2.1 x 0.19    |
| 83956644               | FM1793          | PAPER     | -----             |                 | BRKBAND    | 210.1 x 19.1 x 1.5 8.27 x 0.75 x 0.058  |
| 83958330               | FM3698MP        | STEEL     | -----             | 60              | EXT TH     | 154.2 x 113.8 x 2.6 6.07 x 4.48 x 0.1   |
| 83958468               | FM2969KIT       |           |                   |                 |            |   |
| 83959620               | FM2217          | BRONZE    | SPR/WAG           | 22              | INT TH     | 224.0 x 53.3 x 4.8 8.82 x 2.1 x 0.19    |
| 83959626               | FM2217          | BRONZE    | SPR/WAG           | 22              | INT TH     | 224.0 x 53.3 x 4.8 8.82 x 2.1 x 0.19    |
| 83959970               | FM3035          | PAPER     | WAFFLE            | 22              | INT TH     | 204.5 x 53.3 x 4.8 8.05 x 2.1 x 0.189   |
| 83959971               | FM3038MP        | STEEL     | -----             | 1               | EXT SL     | 236.0 x 85.0 x 2.7 9.29 x 3.35 x 0.106  |
| 83962386               | FM3509          | BRONZE    | SPR/WAG           | 36              | INT TH     | 133.5 x 90.0 x 2.5 5.26 x 3.54 x 0.098  |
| 83962387               | FM2502B         | STEEL     | -----             | 54              | EXT TH     | 139.5 x 98.5 x 1.8 5.49 x 3.88 x 0.069  |
| 83981343               | FM3813          | TAN PAPER | 2 PASS            | 50              | (52) IN TH | 148.6 x 107.7 x 2.7 5.85 x 4.24 x 0.108 |
| 83983209               | FM2215          | BRONZE    | SPR/WAG           | 22              | INT TH     | 204.5 x 53.3 x 4.8 8.05 x 2.1 x 0.19    |
| 83985647               | FM4963          | PAPER     | 2 PASS            | 36              | INT TH     | 133.5 x 90.0 x 2.4 5.26 x 3.54 x 0.096  |
| 83985648               | FM2502B         | STEEL     | -----             | 54              | EXT TH     | 139.5 x 98.5 x 1.8 5.49 x 3.88 x 0.069  |
| 83985649               | FM2502A         | STEEL     | -----             | 54              | EXT TH     | 139.5 x 98.5 x 1.6 5.49 x 3.88 x 0.063  |
| 83989830               | FM2217          | BRONZE    | SPR/WAG           | 22              | INT TH     | 224.0 x 53.3 x 4.8 8.82 x 2.1 x 0.19    |
| 83997678               | FM2954MP        | STEEL     | -----             | 4               | EXT LG     | 228.5 x 147.0 x 2.7 9 x 5.79 x 0.106    |
| 84177629               | FM8068MP        | STEEL     | HARDENED          | 6               | EXT LG     | 152.0 x 100.0 x 1.5 5.98 x 3.94 x 0.059 |
| 84201664               | FM7427          | GRAPHITE  | SUNBURST          | 14              | INT TH     | 328.0 x 90.0 x 9.5 12.91 x 3.54 x 0.374 |
| 85807004               | FM4606MP        | STEEL     | -----             | 3               | EXT LG     | 216.9 x 144.0 x 2.7 8.54 x 5.67 x 0.106 |
| 85807016               | FM4625          | PAPER     | SUNBURST          | 16              | INT TH     | 201.0 x 40.5 x 4.9 7.91 x 1.59 x 0.192  |
| 85808315               | FM6689          | PAPER     | 2 PASS            | 36              | INT TH     | 223.0 x 71.0 x 4.9 8.78 x 2.8 x 0.191   |
| 85808316               | FM3912MP        | END PLATE | -----             | 64              | EXT TH     | 230.0 x 152.5 x 5.0 9.06 x 6.0 x 0.197  |
| 85808317               | FM3414MP        | END PLATE | -----             | 32              | (64)EX TH  | 230.0 x 152.5 x 10.8 9.06 x 6.0 x 0.397 |
| 85808338               | FM4995          | PAPER     | 2 PASS/PLAIN      | 54              | EXT TH     | 139.0 x 99.0 x 2.0 5.47 x 3.9 x 0.077   |
| 85808339               | FM4998MP        | STEEL     | -----             | 45              | INT TH     | 133.0 x 92.7 x 2.0 5.24 x 3.65 x 0.079  |
| 85808340               | FM4993          | PAPER     | 2 PASS            | 54              | EXT TH     | 139.0 x 99.0 x 2.7 5.47 x 3.9 x 0.104   |
| 85827747               | FM7337          | PAPER     | 2 PASS            | 36              | INT TH     | 223.0 x 71.0 x 4.9 8.78 x 2.8 x 0.191   |
| 85827748               | FM3910MP        | END PLATE | -----             | 64              | EXT TH     | 230.0 x 151.0 x 9.0 9.06 x 5.94 x 0.354 |
| 85999292               | FM1359          | BRONZE    | SPIRAL            | 45              | INT TH     | 133.1 x 92.7 x 1.6 5.24 x 3.65 x 0.063  |
| 86014786               | FM8661          | CARBON PA | SUNBURST          | 15              | INT TH     | 367.8 x 87.5 x 9.4 14.48 x 3.44 x 0.37  |
| 86014787               | FM4007          | GRAPHITE  | SUNBURST          | 17              | INT TH     | 368.0 x 79.0 x 9.6 14.49 x 3.11 x 0.376 |
| 86020643               | FM1381OE        | BRONZE    | RADIAL            | 52              | INT TH     | 148.6 x 107.7 x 2.9 5.85 x 4.24 x 0.114 |
| 86029058               | FM3813          | TAN PAPER | 2 PASS            | 50              | (52) IN TH | 148.6 x 107.7 x 2.7 5.85 x 4.24 x 0.108 |
| 86500733               | FM3813          | TAN PAPER | 2 PASS            | 50              | (52) IN TH | 148.6 x 107.7 x 2.7 5.85 x 4.24 x 0.108 |
| 86502577               | FM6559          | PAPER     | WAFFLE            |                 | PAD        |   |
| 86502678               | FM6561          | PAPER     | WAFFLE            |                 | PAD        |   |
| 86505508               | TBA             | STEEL     | -----             | 41              | INT TH     | 262.0 x 84.0 x 6.0 10.31 x 3.31 x 0.236 |
| 86505509               | TBA             | STEEL     | -----             | 54              | INT TH     | 262.0 x 68.0 x 6.0 10.31 x 2.68 x 0.236 |
| 86529646               | FM2215          | BRONZE    | SPR/WAG           | 22              | INT TH     | 204.5 x 53.3 x 4.8 8.05 x 2.1 x 0.19    |
| 86990276               | FM7783          | PAPER     | 2 PASS            | 48              | INT TH     | 140.8 x 98.9 x 2.0 5.54 x 3.89 x 0.079  |
| 87305713               | FM3035          | PAPER     | WAFFLE            | 22              | INT TH     | 204.5 x 53.3 x 4.8 8.05 x 2.1 x 0.189   |
| 87308018               | FM2640MP        | STEEL     | -----             | 1               | EXT SL     | 209.2 x 124.0 x 4.5 8.24 x 4.88 x 0.177 |

| REPLACES<br>OEM PT.NO. | FMC<br>PART NO. | MATERIAL                              | GROOVE<br>DETAILS | TEETH/<br>TANGS |           | SIZE MM |   |       |   | SIZE INCH |       |   |       |   |       |
|------------------------|-----------------|---------------------------------------|-------------------|-----------------|-----------|---------|---|-------|---|-----------|-------|---|-------|---|-------|
| 87341835               | FM4183          | PAPER                                 | WAF/WAG           | 64              | INT TH    | 345.0   | x | 252.1 | x | 4.7       | 13.58 | x | 9.93  | x | 0.185 |
| 87365252               | FM4183          | PAPER                                 | WAF/WAG           | 64              | INT TH    | 345.0   | x | 252.1 | x | 4.7       | 13.58 | x | 9.93  | x | 0.185 |
| 87404476               | FM8920MP        | STEEL                                 | -----             | 4               | EXT LG    | 154.0   | x | 97.0  | x | 1.9       | 6.06  | x | 3.82  | x | 0.075 |
| 87404486               | FM8917          | PAPER                                 | WAFFLE            | 60              | (70)IN TH | 141.0   | x | 87.5  | x | 1.8       | 5.55  | x | 3.44  | x | 0.071 |
| 87441328               | FM5572MP        | STEEL                                 | -----             | 20              | EXT LG    | 372.5   | x | 262.5 | x | 2.0       | 14.67 | x | 10.33 | x | 0.079 |
| 87454125               | FM5250-3.0      | STEEL                                 | HARDENED          | 4               | EXT LG    | 189.8   | x | 92.1  | x | 3.0       | 7.47  | x | 3.63  | x | 0.118 |
| 87454126               | FM5250-2.7      | STEEL                                 | HARDENED          | 4               | EXT LG    | 189.8   | x | 92.1  | x | 2.7       | 7.47  | x | 3.63  | x | 0.106 |
| 87454127               | FM5250-2.9      | STEEL                                 | HARDENED          | 4               | EXT LG    | 189.8   | x | 92.1  | x | 2.9       | 7.47  | x | 3.63  | x | 0.114 |
| 87454128               | FM5250-3.1      | STEEL                                 | HARDENED          | 4               | EXT LG    | 189.8   | x | 92.1  | x | 3.1       | 7.47  | x | 3.63  | x | 0.122 |
| 87454129               | FM5250-3.2      | STEEL                                 | HARDENED          | 4               | EXT LG    | 189.8   | x | 92.1  | x | 3.2       | 7.47  | x | 3.63  | x | 0.126 |
| 87454130               | FM5250-3.3      | STEEL                                 | HARDENED          | 4               | EXT LG    | 189.8   | x | 92.1  | x | 3.3       | 7.47  | x | 3.63  | x | 0.13  |
| 87454841               | FM8681          | PAPER                                 | WAFFLE            | 78              | INT TH    | 446.0   | x | 312.0 | x | 4.8       | 17.56 | x | 12.28 | x | 0.187 |
| 87454847               | FM8684MP        | STEEL                                 | -----             | 20              | EXT LG    | 473.0   | x | 322.0 | x | 4.0       | 18.62 | x | 12.68 | x | 0.157 |
| 87516068               | FM6191          | CARBON CLOTH                          | WAFFLE            | 14              | INT TH    | 326.5   | x | 60.2  | x | 9.8       | 12.85 | x | 2.37  | x | 0.386 |
| 87518036               | FM2217G         | WITHDRAWN FROM SALE, ONLY OFFER FM221 |                   |                 |           |         |   |       |   |           |       |   |       |   |       |
| 87521418               | FM6417          | BRONZE                                | WAF/WAG           | 64              | INT TH    | 345.0   | x | 252.0 | x | 3.8       | 13.58 | x | 9.92  | x | 0.15  |
| 87521419               | FM6454MP        | STEEL                                 | HARDENED          | 20              | EXT LG    | 374.0   | x | 262.0 | x | 2.4       | 14.72 | x | 10.31 | x | 0.094 |
| 87521431               | FM7126-2.9      | STEEL                                 | HARDENED          | 4               | EXT LG    | 164.8   | x | 82.4  | x | 2.9       | 6.49  | x | 4.24  | x | 0.114 |
| 87521432               | FM7126-3.0      | STEEL                                 | HARDENED          | 4               | EXT LG    | 164.8   | x | 82.4  | x | 3.0       | 6.49  | x | 4.24  | x | 0.118 |
| 87525157               | FM5161          | PAPER                                 | 3 PASS            | 14              | INT TH    | 327.0   | x | 60.0  | x | 10.0      | 12.87 | x | 2.36  | x | 0.394 |
| 87530788               | FM7829KIT       | KIT                                   |                   |                 |           |         |   |       |   |           |       |   |       |   |       |
| 87530789               | FM9315KIT       | KIT                                   |                   |                 |           |         |   |       |   |           |       |   |       |   |       |
| 87530793               | FM9319KIT       | KIT                                   |                   |                 |           |         |   |       |   |           |       |   |       |   |       |
| 87530794               | FM9317KIT       | KIT                                   |                   |                 |           |         |   |       |   |           |       |   |       |   |       |
| 87530795               | FM7831KIT       | KIT                                   |                   |                 |           |         |   |       |   |           |       |   |       |   |       |
| 87582473               | FM4288MP        | STEEL                                 | -----             | 45              | INT TH    | 185.0   | x | 132.7 | x | 4.0       | 7.28  | x | 5.22  | x | 0.157 |
| 87582474               | FM4286MP        | STEEL                                 | -----             | 45              | INT TH    | 185.0   | x | 132.7 | x | 3.5       | 7.28  | x | 5.22  | x | 0.138 |
| 87582475               | FM4282MP        | STEEL                                 | -----             | 45              | INT TH    | 185.0   | x | 132.7 | x | 2.5       | 7.28  | x | 5.22  | x | 0.098 |
| 87582476               | FM4284MP        | STEEL                                 | -----             | 45              | INT TH    | 185.0   | x | 132.7 | x | 3.0       | 7.28  | x | 5.22  | x | 0.118 |
| 87588632               | FM7449          | PAPER/STL                             | WAFFLE            | 20              | EXT LG    | 373.4   | x | 262.6 | x | 3.4       | 14.7  | x | 10.34 | x | 0.134 |
| 87602403               | FM6926MP        | STEEL                                 | HARDENED          | 48              | EXT TH    | 99.5    | x | 77.2  | x | 1.1       | 3.92  | x | 3.04  | x | 0.043 |
| 87602404               | FM6923          | BRONZE                                | WAFFLE            | 37              | INT TH    | 93.8    | x | 72.5  | x | 2.3       | 3.69  | x | 2.85  | x | 0.091 |
| 87622084               | FM7888MP        | STEEL                                 | -----             | 6               | EXT LG    | 158.0   | x | 107.2 | x | 1.2       | 6.22  | x | 4.22  | x | 0.047 |
| 87625345               | FM7359          | CARBON PA                             | 3 PASS            | 54              | INT TH    | 324.3   | x | 224.4 | x | 5.0       | 12.77 | x | 8.83  | x | 0.197 |
| 87625346               | FM7362MP        | STEEL                                 | -----             | 4               | EXT LG    | 348.7   | x | 243.5 | x | 5.0       | 13.73 | x | 9.59  | x | 0.197 |
| 87701327               | FM6593KIT       | 5 X PAPER + 5 X STEEL                 |                   |                 |           |         |   |       |   |           |       |   |       |   |       |
| 87708433               | FM6590MP        | STEEL                                 | -----             | 3               | EXT SL    | 335.5   | x | 188.4 | x | 5.0       | 13.21 | x | 7.42  | x | 0.197 |
| 87708434               | FM6587          | PAPER                                 | WAFFLE            | 15              | INT TH    | 289.0   | x | 43.0  | x | 6.7       | 11.38 | x | 1.69  | x | 0.262 |
| 87708435               | FM6592MP        | STEEL                                 | -----             | 3               | EXT SL    | 335.5   | x | 188.4 | x | 8.0       | 13.21 | x | 7.42  | x | 0.315 |
| 87723854               | FM8483          | GRAPHITE                              | SUN/RAD           | 28              | INT TH    | 242.6   | x | 56.1  | x | 4.8       | 9.55  | x | 2.21  | x | 0.189 |
| 87723855               | FM7274MP        | STEEL                                 | -----             | 2               | EXT LG    | 288.0   | x | 156.0 | x | 3.0       | 11.34 | x | 6.14  | x | 0.118 |
| 87738316               | FM8336MP        | STEEL                                 | -----             | 6               | EXT LG    | 158.0   | x | 107.2 | x | 2.0       | 6.22  | x | 4.22  | x | 0.079 |
| 87774810               | FM7888MP        | STEEL                                 | -----             | 6               | EXT LG    | 158.0   | x | 107.2 | x | 1.2       | 6.22  | x | 4.22  | x | 0.047 |
| 87774811               | FM7783          | PAPER                                 | 2 PASS            | 48              | INT TH    | 140.8   | x | 98.9  | x | 2.0       | 5.54  | x | 3.89  | x | 0.079 |
| 87791077               | FM8802MP        | STEEL                                 | -----             | 29              | EXT TH    | 119.5   | x | 88.8  | x | 1.0       | 4.7   | x | 3.5   | x | 0.039 |
| 87791078               | FM8799          | CARBON PA                             | 2 PASS            | 38              | INT TH    | 113.0   | x | 77.1  | x | 1.5       | 4.45  | x | 3.04  | x | 0.059 |
| 89823447               | FM4007          | GRAPHITE                              | SUNBURST          | 17              | INT TH    | 368.0   | x | 79.0  | x | 9.6       | 14.49 | x | 3.11  | x | 0.376 |

| REPLACES OEM PT.NO. | FMC PART NO. | MATERIAL | GROOVE DETAILS | TEETH/TANGS | SIZE MM |       |   | SIZE INCH |   |     |      |   |      |   |       |
|---------------------|--------------|----------|----------------|-------------|---------|-------|---|-----------|---|-----|------|---|------|---|-------|
| 89823827            | FM3698MP     | STEEL    | -----          | 60          | EXT TH  | 154.2 | x | 113.8     | x | 2.6 | 6.07 | x | 4.48 | x | 0.1   |
| 83930407            | FM2971       | BRONZE   | WAFFLE         | 22          | INT TH  | 71.7  | x | 44.0      | x | 2.8 | 2.82 | x | 1.73 | x | 0.11  |
| 83930408            | FM3474MP     | STEEL    | -----          | 4           | EXT LG  | 85.0  | x | 49.2      | x | 1.5 | 3.35 | x | 1.94 | x | 0.059 |
| 83930409            | FM2969       | BRONZE   | WAFFLE         | 22          | INT TH  | 71.7  | x | 44.0      | x | 1.6 | 2.82 | x | 1.73 | x | 0.063 |

### NIIGATA

|               |          |             |          |    |        |       |   |       |   |     |       |   |      |   |       |
|---------------|----------|-------------|----------|----|--------|-------|---|-------|---|-----|-------|---|------|---|-------|
| Mar-88        | FM2633   | BRONZE      | SUNBURST | 66 | EXT TH | 142.6 | x | 85.7  | x | 2.8 | 5.61  | x | 3.37 | x | 0.11  |
| 3-8088A,E     | FM7275   | BRONZE      | SUNBURST | 66 | EXT TH | 142.6 | x | 85.7  | x | 2.5 | 5.61  | x | 3.37 | x | 0.098 |
| 3-8088R,S,W,X | FM4849   | PAPER       | WAFFLE   | 66 | EXT TH | 141.3 | x | 85.5  | x | 2.5 | 5.56  | x | 3.37 | x | 0.098 |
| 3-8088U       | FM5171   | PAPER       | WAFFLE   | 66 | EXT TH | 143.1 | x | 93.5  | x | 2.4 | 5.63  | x | 3.68 | x | 0.094 |
| 3-8088V       | FM5173   | PAPER/STL   | WAFFLE   | 66 | EXT TH | 143.1 | x | 93.5  | x | 1.8 | 5.63  | x | 3.68 | x | 0.071 |
| Mar-89        | FM2636MP | STEEL       | -----    | 38 | INT TH | 133.0 | x | 77.0  | x | 1.5 | 5.24  | x | 3.03 | x | 0.059 |
| 3-8089A       | FM7278MP | STEEL       | -----    | 38 | INT TH | 133.0 | x | 77.2  | x | 2.0 | 5.24  | x | 3.04 | x | 0.079 |
| 3-8089C       | FM2636MP | STEEL       | -----    | 38 | INT TH | 133.0 | x | 77.0  | x | 1.5 | 5.24  | x | 3.03 | x | 0.059 |
| 3-8089-G      | FM4180MP | STEEL       | -----    | 42 | INT TH | 132.8 | x | 85.5  | x | 1.5 | 5.23  | x | 3.37 | x | 0.059 |
| Mar-35        | FM4390MP | STEEL       | -----    | 28 | INT TH | 75.0  | x | 42.0  | x | 1.3 | 2.95  | x | 1.65 | x | 0.051 |
| Mar-36        | FM4387   | BRONZE      | WAFFLE   | 8  | EXT LG | 90.0  | x | 48.0  | x | 2.2 | 3.54  | x | 1.89 | x | 0.087 |
| 3-8673C       | FM6193   | BRONZE      | RADIAL   | 8  | EXT LG | 102.9 | x | 58.0  | x | 2.5 | 4.05  | x | 2.28 | x | 0.098 |
| 3-8673E       | FM6193   | BRONZE      | RADIAL   | 8  | EXT LG | 102.9 | x | 58.0  | x | 2.5 | 4.05  | x | 2.28 | x | 0.098 |
| Mar-74        | FM6196MP | STEEL       | -----    | 34 | INT TH | 86.6  | x | 51.6  | x | 1.2 | 3.41  | x | 2.03 | x | 0.047 |
| 3-8824A       | FM4178MP | STEEL       | DISHED   | 48 | INT TH | 151.0 | x | 98.2  | x | 1.5 | 5.94  | x | 3.87 | x | 0.059 |
| 3-8825E       | FM2653B  | BRONZE      | SUNBURST | 76 | EXT TH | 164.0 | x | 110.0 | x | 2.2 | 6.46  | x | 4.33 | x | 0.087 |
| 3-8827A       | FM5920MP | STEEL       | -----    | 42 | INT TH | 101.6 | x | 64.6  | x | 1.9 | 4.0   | x | 2.54 | x | 0.073 |
| 3-8828E       | FM5917   | BRONZE      | RADIAL   | 68 | EXT TH | 112.3 | x | 71.3  | x | 2.8 | 4.42  | x | 2.81 | x | 0.11  |
| 3-30045       | FM5466MP | STEEL       | -----    | 89 | EXT TH | 285.8 | x | 225.0 | x | 2.3 | 11.25 | x | 8.86 | x | 0.091 |
| 3-31024       | FM2653B  | BRONZE      | SUNBURST | 76 | EXT TH | 164.0 | x | 110.0 | x | 2.2 | 6.46  | x | 4.33 | x | 0.087 |
| 3-31024-F     | FM8711   | PAPER       | WAFFLE   | 76 | EXT TH | 164.0 | x | 110.0 | x | 2.4 | 6.46  | x | 4.33 | x | 0.094 |
| 3-31024-G     | FM8713   | PAPER/PLAIN | WAFFLE   | 76 | EXT TH | 164.0 | x | 110.0 | x | 1.8 | 6.46  | x | 4.33 | x | 0.071 |
| 3-31025B      | FM5182MP | STEEL       | -----    | 48 | INT TH | 151.0 | x | 98.2  | x | 2.0 | 5.94  | x | 3.87 | x | 0.079 |
| 3-31025-C     | FM4178MP | STEEL       | DISHED   | 48 | INT TH | 151.0 | x | 98.2  | x | 1.5 | 5.94  | x | 3.87 | x | 0.059 |
| 3-37461       | FM7279   | BRONZE      | SUNBURST | 72 | EXT TH | 155.7 | x | 105.0 | x | 2.2 | 6.13  | x | 4.13 | x | 0.087 |
| 3-37480-A     | FM7282MP | STEEL       | -----    | 44 | INT TH | 146.2 | x | 90.0  | x | 2.0 | 5.76  | x | 3.54 | x | 0.079 |
| 3-37480       | FM4178MP | STEEL       | DISHED   | 48 | INT TH | 151.0 | x | 98.2  | x | 1.5 | 5.94  | x | 3.87 | x | 0.059 |
| 3-42582       | FM4849   | PAPER       | WAFFLE   | 66 | EXT TH | 141.3 | x | 85.5  | x | 2.5 | 5.56  | x | 3.37 | x | 0.098 |
| 5-34400       | FM4612MP | STEEL       | -----    | 59 | INT TH | 177.0 | x | 121.5 | x | 2.4 | 6.97  | x | 4.78 | x | 0.094 |
| 5-34401       | FM4609   | BRONZE      | SUNBURST | 88 | EXT TH | 189.0 | x | 134.3 | x | 3.1 | 7.44  | x | 5.29 | x | 0.122 |
| 5-43327-C     | FM7529   | PAPER       | 2 PASS   | 88 | EXT TH | 189.5 | x | 134.0 | x | 2.8 | 7.46  | x | 5.28 | x | 0.11  |

### NISSAN

|             |           |            |              |    |        |       |   |      |   |     |      |   |     |   |       |
|-------------|-----------|------------|--------------|----|--------|-------|---|------|---|-----|------|---|-----|---|-------|
| 31530-50K00 | FM6909KIT | 1 X FM2061 | 1 X FM2074MP |    |        |       |   |      |   |     |      |   |     |   |       |
| 31532-22H00 | FM1805    | BRONZE     | SUNBURST     | 41 | INT TH | 125.0 | x | 68.6 | x | 2.6 | 4.92 | x | 2.7 | x | 0.102 |
| 31532-22H01 | FM1805    | BRONZE     | SUNBURST     | 41 | INT TH | 125.0 | x | 68.6 | x | 2.6 | 4.92 | x | 2.7 | x | 0.102 |
| 31532-25H00 | FM7301    | 2 PASS     | WAFFLE       | 41 | INT TH | 125.0 | x | 68.6 | x | 2.6 | 4.92 | x | 2.7 | x | 0.102 |
| 31532-25H01 | FM7301    | 2 PASS     | WAFFLE       | 41 | INT TH | 125.0 | x | 68.6 | x | 2.6 | 4.92 | x | 2.7 | x | 0.102 |
| 31532-40K00 | FM7301    | 2 PASS     | WAFFLE       | 41 | INT TH | 125.0 | x | 68.6 | x | 2.6 | 4.92 | x | 2.7 | x | 0.102 |
| 31532-4G000 | FM7301    | 2 PASS     | WAFFLE       | 41 | INT TH | 125.0 | x | 68.6 | x | 2.6 | 4.92 | x | 2.7 | x | 0.102 |
| 31532-41K00 | FM7301    | 2 PASS     | WAFFLE       | 41 | INT TH | 125.0 | x | 68.6 | x | 2.6 | 4.92 | x | 2.7 | x | 0.102 |

| REPLACES<br>OEM PT.NO. | FMC<br>PART NO. | MATERIAL  | GROOVE<br>DETAILS | TEETH/<br>TANGS | SIZE MM   |       |   | SIZE INCH |   |     |      |   |      |   |       |
|------------------------|-----------------|-----------|-------------------|-----------------|-----------|-------|---|-----------|---|-----|------|---|------|---|-------|
| 31532-51H00            | FM2135          | PAPER     | 2 PASS            | 38              | INT TH    | 133.6 | x | 77.0      | x | 2.8 | 5.26 | x | 3.03 | x | 0.11  |
| 31532-53H00            | FM3361          | PAPER     | WAFFLE            | 38              | INT TH    | 158.0 | x | 95.2      | x | 2.7 | 6.22 | x | 3.75 | x | 0.106 |
| 31532-FJ100            | FM2061          | PAPER     | WAFFLE            | 41              | INT TH    | 125.0 | x | 68.6      | x | 2.6 | 4.92 | x | 2.7  | x | 0.102 |
| 31532-GL00A            | FM4983          | PAPER     | WAFFLE            | 38              | INT TH    | 133.6 | x | 77.0      | x | 3.0 | 5.26 | x | 3.03 | x | 0.116 |
| 31532-L1000            | FM1805          | BRONZE    | SUNBURST          | 41              | INT TH    | 125.0 | x | 68.6      | x | 2.6 | 4.92 | x | 2.7  | x | 0.102 |
| 31532-L1500            | FM7301          | 2 PASS    | WAFFLE            | 41              | INT TH    | 125.0 | x | 68.6      | x | 2.6 | 4.92 | x | 2.7  | x | 0.102 |
| 31532-L6000            | FM2135          | PAPER     | 2 PASS            | 38              | INT TH    | 133.6 | x | 77.0      | x | 2.8 | 5.26 | x | 3.03 | x | 0.11  |
| 31534-25H00            | FM3730MP        | STEEL     | DISHED            | 42              | EXT TH    | 131.4 | x | 80.0      | x | 2.0 | 5.17 | x | 3.15 | x | 0.079 |
| 31536-22H00            | FM2698MP        | STEEL     | -----             | 42              | EXT TH    | 131.4 | x | 77.2      | x | 1.8 | 5.17 | x | 3.04 | x | 0.071 |
| 31536-25H00            | FM2642MP        | STEEL     | -----             | 42              | EXT TH    | 131.4 | x | 80.0      | x | 1.6 | 5.17 | x | 3.15 | x | 0.063 |
| 31536-41K00            | FM3368MP        | STEEL     | -----             | 24              | EXT TH    | 132.0 | x | 80.0      | x | 1.6 | 5.2  | x | 3.15 | x | 0.063 |
| 31536-4G000            | FM2074MP        | STEEL     | -----             | 8               | EXT LG    | 131.6 | x | 80.0      | x | 1.6 | 5.18 | x | 3.15 | x | 0.063 |
| 31536-53H00            | FM3360MP        | STEEL     | -----             | 64              | EXT TH    | 164.3 | x | 107.0     | x | 2.0 | 6.47 | x | 4.21 | x | 0.079 |
| 31536-FJ100            | FM3368MP        | STEEL     | -----             | 24              | EXT TH    | 132.0 | x | 80.0      | x | 1.6 | 5.2  | x | 3.15 | x | 0.063 |
| 31536-GL00A            | FM4986MP        | STEEL     | -----             | 34              | EXT TH    | 143.0 | x | 87.5      | x | 2.3 | 5.63 | x | 3.44 | x | 0.09  |
| 31536-L1002            | FM2074MP        | STEEL     | -----             | 8               | EXT LG    | 131.6 | x | 80.0      | x | 1.6 | 5.18 | x | 3.15 | x | 0.063 |
| 31536-L1500            | FM2074MP        | STEEL     | -----             | 8               | EXT LG    | 131.6 | x | 80.0      | x | 1.6 | 5.18 | x | 3.15 | x | 0.063 |
| 31536-L6000            | FM2352MP        | STEEL     | -----             | 8               | EXT LG    | 149.9 | x | 87.4      | x | 2.3 | 5.9  | x | 3.44 | x | 0.091 |
| 31536-L6001            | FM2352MP        | STEEL     | -----             | 8               | EXT LG    | 149.9 | x | 87.4      | x | 2.3 | 5.9  | x | 3.44 | x | 0.091 |
| 31536-L9060            | FM2906MP        | STEEL     | -----             | 54              | EXT TH    | 139.5 | x | 87.3      | x | 2.3 | 5.49 | x | 3.44 | x | 0.091 |
| 31537-25H02            | FM3732MP        | STEEL     | -----             | 42              | EXT TH    | 131.4 | x | 80.0      | x | 4.4 | 5.17 | x | 3.15 | x | 0.171 |
| 31537-25H04            | FM4030MP        | END PLATE | -----             | 42              | EXT TH    | 131.4 | x | 80.0      | x | 4.7 | 5.17 | x | 3.15 | x | 0.186 |
| 31537-40K00            | FM3372MP        | STEEL     | -----             | 8               | EXT LG    | 131.0 | x | 77.0      | x | 3.0 | 5.16 | x | 3.03 | x | 0.118 |
| 31537-L1000            | FM3458MP        | STEEL     | -----             | 8               | EXT LG    | 131.0 | x | 77.0      | x | 4.0 | 5.16 | x | 3.03 | x | 0.157 |
| 31537-L1002            | FM5078MP        | STEEL     | -----             | 8               | EXT LG    | 130.8 | x | 77.0      | x | 3.5 | 5.15 | x | 3.03 | x | 0.137 |
| 44060-GA10A            | FM5553          | BRONZE    | SUNBURST          | 27              | INT TH    | 112.0 | x | 78.5      | x | 1.8 | 4.41 | x | 3.09 | x | 0.069 |
| 44063-GA10A            | FM5556MP        | STEEL     | -----             | 4               | EXT LG    | 133.7 | x | 86.2      | x | 1.7 | 5.26 | x | 3.39 | x | 0.068 |
| <b>NOVA DETAS</b>      |                 |           |                   |                 |           |       |   |           |   |     |      |   |      |   |       |
| 1640020                | FM4815          | GRAPHITE  | SUNBURST          | 36              | (73)EX TH | 151.5 | x | 101.5     | x | 3.5 | 5.96 | x | 4.0  | x | 0.138 |

| REPLACES<br>OEM PT.NO. | FMC<br>PART NO. | MATERIAL   | GROOVE<br>DETAILS | TEETH/<br>TANGS | SIZE MM    |       |   |       | SIZE INCH |     |       |   |       |   |       |
|------------------------|-----------------|------------|-------------------|-----------------|------------|-------|---|-------|-----------|-----|-------|---|-------|---|-------|
| <b>O &amp; K</b>       |                 |            |                   |                 |            |       |   |       |           |     |       |   |       |   |       |
| 243 276                | FM3017          | BRONZE     | SUNBURST          | 68              | EXT TH     | 208.0 | x | 145.0 | x         | 3.5 | 8.19  | x | 5.71  | x | 0.138 |
| 059 7367               | FM1216MP        | STEEL      | -----             | 60              | EXT TH     | 154.2 | x | 113.8 | x         | 1.8 | 6.07  | x | 4.48  | x | 0.07  |
| 097 1051               | FM5936MP        | OBSOLETE   | -----             | 54              | (66)EX TH  | 326.0 | x | 194.2 | x         | 4.0 | 12.83 | x | 7.65  | x | 0.157 |
| 118 6315               | FM4347          | BRONZE     | WAFFLE            | 65              | (75)EX TH  | 190.5 | x | 132.0 | x         | 1.8 | 7.5   | x | 5.2   | x | 0.071 |
| 118 6316               | FM6406MP        | STEEL      | HARDENED          | 31              | INT TH     | 180.0 | x | 122.1 | x         | 2.0 | 7.09  | x | 4.81  | x | 0.078 |
| 140 7157               | FM5439          | BRONZE     | SPR/RAD           | 98              | (112)EX TH | 340.0 | x | 235.0 | x         | 4.5 | 13.39 | x | 9.25  | x | 0.177 |
| 140 9327               | FM3602MP        | STEEL      | -----             | 35              | INT TH     | 170.9 | x | 102.9 | x         | 2.0 | 6.73  | x | 4.05  | x | 0.079 |
| 141 0250               | FM4449          | MOLYBDENUM | SPR/WAG           | 26              | INT TH     | 147.8 | x | 75.4  | x         | 3.0 | 5.82  | x | 2.97  | x | 0.118 |
| 141 7003               | FM2277          | BRONZE     | SUNBURST          | 27              | EXT TH     | 137.4 | x | 90.9  | x         | 2.0 | 5.41  | x | 3.58  | x | 0.079 |
| 143 1128               | FM2279          | BRONZE     | SUNBURST          | 35              | EXT TH     | 177.5 | x | 109.0 | x         | 2.0 | 6.99  | x | 4.29  | x | 0.079 |
| 143 1129               | FM3604MP        | STEEL      | -----             | 35              | INT TH     | 170.9 | x | 102.9 | x         | 2.5 | 6.73  | x | 4.05  | x | 0.098 |
| 143 1430               | FM3600MP        | STEEL      | -----             | 35              | INT TH     | 170.9 | x | 102.9 | x         | 1.5 | 6.73  | x | 4.05  | x | 0.059 |
| 143 5645               | FM2962MP        | STEEL      | -----             | 37              | INT TH     | 204.6 | x | 143.8 | x         | 2.0 | 8.06  | x | 5.66  | x | 0.079 |
| 143 5646               | FM2943          | BRONZE     | SPR/RAD           | 42              | EXT TH     | 212.5 | x | 154.5 | x         | 2.5 | 8.37  | x | 6.08  | x | 0.098 |
| 144 4870               | FM6926MP        | STEEL      | HARDENED          | 48              | EXT TH     | 99.5  | x | 77.2  | x         | 1.1 | 3.92  | x | 3.04  | x | 0.043 |
| 144 4871               | FM6923          | BRONZE     | WAFFLE            | 37              | INT TH     | 93.8  | x | 72.5  | x         | 2.3 | 3.69  | x | 2.85  | x | 0.091 |
| 146 2673               | FM3575          | PAPER      | 3 PASS            | 35              | INT TH     | 179.0 | x | 103.0 | x         | 3.5 | 7.05  | x | 4.05  | x | 0.138 |
| 147 6518               | FM6406MP        | STEEL      | HARDENED          | 31              | INT TH     | 180.0 | x | 122.1 | x         | 2.0 | 7.09  | x | 4.81  | x | 0.078 |
| 147 7302               | FM6930MP        | STEEL      | HARDENED          | 45              | INT TH     | 123.9 | x | 89.2  | x         | 2.0 | 4.88  | x | 3.51  | x | 0.079 |
| 147 9860               | FM9056MP        | STEEL      | HARDENED          | 33              | (39)IN TH  | 234.8 | x | 154.0 | x         | 2.7 | 9.24  | x | 6.6   | x | 0.106 |
| 147 9886               | FM4347          | BRONZE     | WAFFLE            | 65              | (75)EX TH  | 190.5 | x | 132.0 | x         | 1.8 | 7.5   | x | 5.2   | x | 0.071 |
| 148 2096               | FM7215          | BRONZE     | WAFFLE            | 54              | EXT TH     | 109.5 | x | 81.6  | x         | 1.9 | 4.31  | x | 3.21  | x | 0.075 |
| 148 2097               | FM7218MP        | STEEL      | -----             | 52              | INT TH     | 102.0 | x | 77.0  | x         | 1.5 | 4.02  | x | 3.03  | x | 0.059 |
| 148 2127               | FM9053          | BRONZE     | SUN/WAF           | 42              | (48)EX TH  | 248.5 | x | 164.7 | x         | 2.6 | 9.78  | x | 6.48  | x | 0.102 |
| 154 7834               | FM5576MP        | STEEL      | -----             | 35              | (44)IN TH  | 180.0 | x | 109.0 | x         | 2.0 | 7.09  | x | 4.29  | x | 0.079 |
| 217 7461               | FM5907          | PAPER      | 2 PASS            | 34              | INT TH     | 305.0 | x | 170.0 | x         | 4.5 | 12.01 | x | 6.69  | x | 0.177 |
| 222 3816               | FM6927          | BRONZE     | WAFFLE            | 64              | EXT TH     | 129.5 | x | 96.1  | x         | 1.7 | 5.1   | x | 3.78  | x | 0.065 |
| 226 8264               | FM6219          | OBSOLETE   | SPR/RAD           | 95              | EXT TH     | 289.0 | x | 189.7 | x         | 3.5 | 11.38 | x | 7.47  | x | 0.138 |
| 226 8265               | FM6850MP        | OBSOLETE   | -----             | 36              | INT TH     | 274.8 | x | 180.3 | x         | 3.0 | 10.82 | x | 7.1   | x | 0.118 |
| 281 0279               | FM8978MP        | STEEL      | -----             | 6               | EXT LG     | 265.8 | x | 147.0 | x         | 4.0 | 10.46 | x | 5.79  | x | 0.157 |
| 281 0288               | FM8975          | CARBON PA  | 4 PASS            | 32              | INT TH     | 236.0 | x | 94.1  | x         | 5.5 | 9.29  | x | 3.7   | x | 0.217 |
| 289 4131               | FM7215          | BRONZE     | WAFFLE            | 54              | EXT TH     | 109.5 | x | 81.6  | x         | 1.9 | 4.31  | x | 3.21  | x | 0.075 |
| 289 4142               | FM9056MP        | STEEL      | HARDENED          | 33              | (39)IN TH  | 234.8 | x | 154.0 | x         | 2.7 | 9.24  | x | 6.6   | x | 0.106 |
| 289 4284               | FM9053          | BRONZE     | SUN/WAF           | 42              | (48)EX TH  | 248.5 | x | 164.7 | x         | 2.6 | 9.78  | x | 6.48  | x | 0.102 |
| 460 9399               | FM1790MP        | STEEL      | -----             | 146             | (164)EX TH | 494.8 | x | 345.9 | x         | 2.4 | 19.48 | x | 13.62 | x | 0.094 |
| 460 9400               | FM1787          | PAPER      | 3 PASS            | 112             | INT TH     | 480.1 | x | 329.9 | x         | 5.1 | 18.9  | x | 12.99 | x | 0.2   |
| 461 1633               | FM2787          | GRAPHITE   | SUNBURST          | 52              | INT TH     | 175.3 | x | 106.7 | x         | 2.9 | 6.9   | x | 4.2   | x | 0.114 |
| 461 1634               | FM2738MP        | STEEL      | -----             | 71              | EXT TH     | 182.6 | x | 117.9 | x         | 1.8 | 7.19  | x | 4.64  | x | 0.069 |
| 461 1825               | FM3612MP        | STEEL      | -----             | 91              | EXT TH     | 355.0 | x | 217.0 | x         | 5.0 | 13.98 | x | 8.54  | x | 0.197 |
| 461 2207               | FM2811          | PAPER      | 4 PASS            | 34              | INT TH     | 277.0 | x | 167.0 | x         | 4.5 | 10.91 | x | 6.57  | x | 0.177 |
| 461 2217               | FM3606MP        | STEEL      | -----             | 88              | (91)EX TH  | 293.0 | x | 185.0 | x         | 4.0 | 11.54 | x | 7.28  | x | 0.157 |
| 462 2237               | FM3610MP        | STEEL      | -----             | 91              | EXT TH     | 355.0 | x | 217.0 | x         | 4.5 | 13.98 | x | 8.54  | x | 0.177 |
| 462 3153               | FM2815          | PAPER      | 4 PASS            | 42              | INT TH     | 340.0 | x | 206.0 | x         | 5.5 | 13.39 | x | 8.11  | x | 0.217 |
| 462 3209               | FM3606MP        | STEEL      | -----             | 88              | (91)EX TH  | 293.0 | x | 185.0 | x         | 4.0 | 11.54 | x | 7.28  | x | 0.157 |
| 478 4907               | FM4397          | BRONZE     | SUNBURST          | 64              | EXT TH     | 196.0 | x | 142.0 | x         | 2.5 | 7.72  | x | 5.59  | x | 0.096 |
| 478 4908               | FM4399          | BRNZ/PLN   | SUNBURST          | 64              | EXT TH     | 196.0 | x | 142.0 | x         | 2.0 | 7.72  | x | 5.59  | x | 0.077 |
| 492 0199               | FM5588MP        | STEEL      | -----             | 6               | EXT LG     | 266.0 | x | 163.0 | x         | 4.0 | 10.47 | x | 6.42  | x | 0.157 |

| REPLACES<br>OEM PT.NO. | FMC<br>PART NO. | MATERIAL   | GROOVE<br>DETAILS | TEETH/<br>TANGS | SIZE MM   | SIZE INCH                                 |
|------------------------|-----------------|------------|-------------------|-----------------|-----------|---|
| 492 0200               | FM5585          | CARBON PA  | 3 PASS            | 28              | INT TH    | 246.0 x 140.0 x 4.5 9.69 x 5.51 x 0.177   |
| 492 0753               | FM5910MP        | STEEL      | -----             | 6               | EXT LG    | 325.0 x 198.0 x 4.5 12.8 x 7.8 x 0.177    |
| 492 2368               | FM7779          | PAPER      | 2 PASS            | 18              | INT TH    | 154.7 x 34.2 x 4.9 6.09 x 1.35 x 0.193    |
| 600 0209               | FM5994MP        | STEEL      | -----             | 22              | INT TH    | 146.0 x 64.0 x 2.0 5.75 x 2.52 x 0.079    |
| 600 0210               | FM5991          | BRONZE     | WAFFLE            | 50              | EXT TH    | 152.5 x 109 x 2.8 6.0 x 4.29 x 0.11       |
| 690 2022               | FM8263          | BRONZE     | WAF/RAD           | 54              | EXT TH    | 109.4 x 82.1 x 1.6 4.31 x 3.23 x 0.063    |
| 730 4760               | FM4289          | BRONZE     | SPR/RAD           | 35              | EXT TH    | 176.5 x 142.0 x 2.5 6.95 x 5.51 x 0.096   |
| 738 0057               | FM3998MP        | STEEL      | "M"               | 45              | EXT TH    | 281.0 x 221.0 x 3.0 11.05 x 8.7 x 0.118   |
| 738 0059               | FM3976MP        | STEEL      | -----             | 34              | (45)EX TH | 281.0 x 221.0 x 2.0 11.05 x 8.7 x 0.079   |
| 738 0065               | FM3972MP        | STEEL      | -----             | 32              | INT TH    | 163.0 x 94.0 x 2.0 6.41 x 3.69 x 0.079    |
| 738 0079               | FM3992MP        | STEEL      | HOLES             | 24              | (32)EX TH | 306.0 x 237.0 x 3.0 12.03 x 9.3 x 0.118   |
| 738 0133               | FM3892MP        | STEEL      | 8 HOLES           | 24              | (32)EX TH | 306.0 x 247.0 x 2.0 12.03 x 9.72 x 0.079  |
| 738 0529               | FM4666-2.2      | STEEL      | HARDENED          | 6               | EXT SL    | 130.0 x 66.8 x 2.2 5.12 x 2.63 x 0.087    |
| 738 0530               | FM4451          | MOLYBDENUM | SPR/WAG           | 46              | (50)IN TH | 117.5 x 62.6 x 2.6 4.63 x 2.46 x 0.102    |
| 738 1130               | FM3592MP        | STEEL      | -----             | 29              | INT TH    | 131.1 x 85.1 x 1.5 5.16 x 3.35 x 0.059    |
| 738 1131               | FM3594MP        | STEEL      | -----             | 29              | INT TH    | 131.1 x 85.1 x 2.0 5.16 x 3.35 x 0.079    |
| 738 1132               | FM3596MP        | STEEL      | -----             | 29              | INT TH    | 131.1 x 85.1 x 2.5 5.16 x 3.35 x 0.098    |
| 738 1246               | FM3602MP        | STEEL      | -----             | 35              | INT TH    | 170.9 x 102.9 x 2.0 6.73 x 4.05 x 0.079   |
| 738 1248               | FM3600MP        | STEEL      | -----             | 35              | INT TH    | 170.9 x 102.9 x 1.5 6.73 x 4.05 x 0.059   |
| 738 1261               | FM3604MP        | STEEL      | -----             | 35              | INT TH    | 170.9 x 102.9 x 2.5 6.73 x 4.05 x 0.098   |
| 738 2122               | FM3982MP        | STEEL      | -----             | 24              | (32)EX TH | 306.0 x 237.0 x 2.0 12.03 x 9.3 x 0.079   |
| 738 2519               | FM2277          | BRONZE     | SUNBURST          | 27              | EXT TH    | 137.4 x 90.9 x 2.0 5.41 x 3.58 x 0.079    |
| 738 2674               | FM2279          | BRONZE     | SUNBURST          | 35              | EXT TH    | 177.5 x 109.0 x 2.0 6.99 x 4.29 x 0.079   |
| 739 1576               | FM3024MP        | STEEL      | -----             | 12              | EXT LG    | 317.7 x 268.0 x 3.0 12.51 x 10.55 x 0.118 |
| 739 5157               | FM1381OE        | BRONZE     | RADIAL            | 52              | INT TH    | 148.6 x 107.7 x 2.9 5.85 x 4.24 x 0.114   |
| 739 5158               | FM1216MP        | STEEL      | -----             | 60              | EXT TH    | 154.2 x 113.8 x 1.8 6.07 x 4.48 x 0.07    |
| 739 5210               | FM1307OE        | BRONZE     | RADIAL            | 52              | INT TH    | 148.6 x 107.7 x 2.6 5.85 x 4.24 x 0.102   |
| 739 6255               | FM2811          | PAPER      | 4 PASS            | 34              | INT TH    | 277.0 x 167.0 x 4.5 10.91 x 6.57 x 0.177  |
| 739 6717               | FM4123          | BRONZE     | SUN-PLAIN         | 27              | EXT TH    | 137.4 x 90.9 x 1.6 5.41 x 3.58 x 0.063    |
| 739 6895               | FM4125          | BRONZE     | SUN-PLAIN         | 35              | EXT TH    | 177.5 x 109.0 x 1.6 6.99 x 4.29 x 0.063   |
| 802 8455               | FM5641          | PAPER      | 3 PASS            | 92              | INT TH    | 650.0 x 460.0 x 5.1 25.59 x 18.11 x 0.201 |
| 802 8456               | FM5644MP        | STEEL      | -----             | 132             | EXT TH    | 677.7 x 492.6 x 2.4 26.68 x 19.39 x 0.094 |
| 802 8457               | FM5645          | CORK       | -----             | 132             | EXT TH    | 677.7 x 492.6 x 6.9 26.68 x 19.39 x 0.272 |
| 847 9085               | FM3614MP        | STEEL      | -----             | 91              | EXT TH    | 355.0 x 217.0 x 5.5 13.98 x 8.54 x 0.217  |
| <b>OKAMURA</b>         |                 |            |                   |                 |           |   |
| 483016A                | FM3561          | PAPER      | WAFFLE            | 30              | INT TH    | 131.0 x 79.2 x 2.6 5.16 x 3.12 x 0.102    |
| 483017A                | FM2063          | PAPER      | WAFFLE            | 41              | INT TH    | 125.0 x 68.6 x 2.9 4.92 x 2.7 x 0.114     |
| 483116A                | FM3368MP        | STEEL      | -----             | 24              | EXT TH    | 132.0 x 80.0 x 1.6 5.2 x 3.15 x 0.063     |
| 1158300600             | FM2129          | PAPER      | 2 PASS            | 37              | INT TH    | 155.7 x 87.9 x 2.9 6.13 x 3.46 x 0.114    |
| 1158310300             | FM2018MP        | STEEL      | -----             | 12              | EXT LG    | 165.6 x 100.1 x 2.0 6.52 x 3.94 x 0.079   |
| 1158310400             | FM2018MP        | STEEL      | -----             | 12              | EXT LG    | 165.6 x 100.1 x 2.0 6.52 x 3.94 x 0.079   |
| <b>OMCI</b>            |                 |            |                   |                 |           |   |
| 125242                 | FM7032MP        | STEEL      | -----             | 4               | EXT LG    | 300.0 x 127.0 x 4.6 11.81 x 5 x 0.181     |
| 125368                 | FM5459          | GRAPHITE   | SUNBURST          | 25              | INT TH    | 223.5 x 62.0 x 5.7 8.8 x 2.44 x 0.224     |

| REPLACES<br>OEM PT.NO. | FMC<br>PART NO. | MATERIAL             | GROOVE<br>DETAILS | TEETH/<br>TANGS | SIZE MM |       |   | SIZE INCH |   |     |       |   |       |   |       |
|------------------------|-----------------|----------------------|-------------------|-----------------|---------|-------|---|-----------|---|-----|-------|---|-------|---|-------|
| 126367                 | FM4859          | OBSOLETE AFTER STOCK |                   | 64              | INT TH  | 355.5 | x | 200.0     | x | 7.3 | 14    | x | 7.87  | x | 0.285 |
| 126409                 | FM4862MP        | STEEL                | -----             | 6               | EXT SL  | 450.0 | x | 235.0     | x | 7.1 | 17.72 | x | 9.25  | x | 0.278 |
| 186045                 | FM5189          | PAPER                | WAFFLE            | 45              | INT TH  | 195.0 | x | 130.0     | x | 3.8 | 7.68  | x | 5.12  | x | 0.15  |
| 186046                 | FM5192MP        | STEEL                | -----             | 8               | EXT LG  | 214.0 | x | 145.2     | x | 2.0 | 8.43  | x | 5.72  | x | 0.079 |
| 274018                 | FM5911          | GRAPHITE             | SUN/RAD           | 16              | INT TH  | 204.0 | x | 40.0      | x | 4.9 | 8.03  | x | 1.57  | x | 0.193 |
| 274019                 | FM5914MP        | STEEL                | -----             | 2               | EXT LG  | 209.0 | x | 140.0     | x | 2.7 | 8.28  | x | 5.51  | x | 0.106 |
| 286057                 | FM4947          | PAPER                | 3 PASS            | 72              | INT TH  | 467.0 | x | 281.0     | x | 5.5 | 18.38 | x | 11.06 | x | 0.217 |
| 286058                 | FM4950MP        | STEEL                | -----             | 120             | EXT TH  | 483.0 | x | 300.0     | x | 5.0 | 19.02 | x | 11.81 | x | 0.197 |
| 325104                 | FM7187          | GRAPHITE             | SUNBURST          | 35              | INT TH  | 249.0 | x | 84.3      | x | 5.3 | 9.8   | x | 3.32  | x | 0.209 |
| AC4.125242             | FM7032MP        | STEEL                | -----             | 4               | EXT LG  | 300.0 | x | 127.0     | x | 4.6 | 11.81 | x | 5     | x | 0.181 |
| AC4.125368             | FM5459          | GRAPHITE             | SUNBURST          | 25              | INT TH  | 223.5 | x | 62.0      | x | 5.7 | 8.8   | x | 2.44  | x | 0.224 |
| AC4.274018             | FM5911          | GRAPHITE             | SUN/RAD           | 16              | INT TH  | 204.0 | x | 40.0      | x | 4.9 | 8.03  | x | 1.57  | x | 0.193 |
| DO1.274019             | FM5914MP        | STEEL                | -----             | 2               | EXT LG  | 209.0 | x | 140.0     | x | 2.7 | 8.28  | x | 5.51  | x | 0.106 |
| DO2.325104             | FM7187          | GRAPHITE             | SUNBURST          | 35              | INT TH  | 249.0 | x | 84.3      | x | 5.3 | 9.8   | x | 3.32  | x | 0.209 |
| <b>ORMIG</b>           |                 |                      |                   |                 |         |       |   |           |   |     |       |   |       |   |       |
| AC4.274018             | FM5911          | GRAPHITE             | SUN/RAD           | 16              | INT TH  | 204.0 | x | 40.0      | x | 4.9 | 8.03  | x | 1.57  | x | 0.193 |
| DO1.274019             | FM5914MP        | STEEL                | -----             | 2               | EXT LG  | 209.0 | x | 140.0     | x | 2.7 | 8.28  | x | 5.51  | x | 0.106 |
| <b>ORTLINGHAUS</b>     |                 |                      |                   |                 |         |       |   |           |   |     |       |   |       |   |       |
| 3-000-210-51-008       | FM3017          | BRONZE               | SUNBURST          | 68              | EXT TH  | 208.0 | x | 145.0     | x | 3.5 | 8.19  | x | 5.71  | x | 0.138 |
| 3-000-340-51-001       | FM7316MP        | STEEL                | SINEWAVED         | 45              | INT TH  | 195.0 | x | 130.0     | x | 2.3 | 7.68  | x | 5.12  | x | 0.091 |
| 3-002-340-63-020       | FM6060MP        | OBSOLETE             | SINEWAVED         | 60              | INT TH  | 270.0 | x | 175.0     | x | 3.0 | 10.63 | x | 6.89  | x | 0.118 |
| 3-021-632-59-029       | FM6181          | BRONZE               | WAFFLE            | 51              | EXT TH  | 256.0 | x | 198.2     | x | 4.0 | 10.08 | x | 7.8   | x | 0.157 |
| 3-021-744-59-000       | FM6184MP        | STEEL                | SINEWAVED         | 48              | INT TH  | 245.0 | x | 188.0     | x | 3.0 | 9.65  | x | 7.4   | x | 0.118 |
| 3-100-010-25-010       | FM3935          | BRONZE               | SPR/RAD           | 6               | EXT LG  | 122.0 | x | 72.0      | x | 2.4 | 4.8   | x | 2.83  | x | 0.094 |
| 3-100-010-31-010       | FM3933          | BRONZE               | SPR/RAD           | 6               | EXT LG  | 137.0 | x | 84.0      | x | 2.4 | 5.39  | x | 3.31  | x | 0.094 |
| 3-100-010-39-008       | FM4845          | BRONZE               | SPR/RAD           | 6               | EXT LG  | 157.0 | x | 102.0     | x | 2.4 | 6.18  | x | 4.02  | x | 0.094 |
| 3-100-010-39-010       | FM4845          | BRONZE               | SPR/RAD           | 6               | EXT LG  | 157.0 | x | 102.0     | x | 2.4 | 6.18  | x | 4.02  | x | 0.094 |
| 3-100-010-43-010       | FM3173          | BRONZE               | SPR/RAD           | 6               | EXT LG  | 177.0 | x | 118.0     | x | 2.4 | 6.97  | x | 4.65  | x | 0.094 |
| 3-100-015-25-005       | FM4779          | BRONZE               | SPIRAL            | 6               | EXT LG  | 122.0 | x | 72.2      | x | 1.5 | 4.8   | x | 2.84  | x | 0.059 |
| 3-100-140-31-001       | FM4848MP        | STEEL                | SINEWAVED         | 3               | INT TH  | 123.0 | x | 72.2      | x | 1.5 | 4.84  | x | 2.84  | x | 0.059 |
| 3-100-210-43-008       | FM3523          | BRONZE               | SPR/RAD           | 68              | EXT TH  | 173.0 | x | 118.0     | x | 2.4 | 6.81  | x | 4.65  | x | 0.094 |
| 3-100-210-47-008       | FM2679          | BRONZE               | SPR/RAD           | 62              | EXT TH  | 188.0 | x | 132.0     | x | 2.4 | 7.4   | x | 5.2   | x | 0.094 |
| 3-100-210-55-008       | FM3417          | BRONZE               | SPR/RAD           | 78              | EXT TH  | 236.0 | x | 155.0     | x | 4.0 | 9.29  | x | 6.1   | x | 0.157 |
| 3-100-210-75-008       | FM8983          | BRONZE               | SPR/RAD           | 100             | EXT TH  | 403.8 | x | 285.0     | x | 5.5 | 15.9  | x | 11.22 | x | 0.217 |
| 3-100-233-63-029       | FM6057          | OBSOLETE             | WAFFLE            | 95              | EXT TH  | 287.0 | x | 189.0     | x | 4.0 | 11.3  | x | 7.44  | x | 0.157 |
| 3-100-340-39-001       | FM4330MP        | STEEL                | -----             | 38              | INT TH  | 140.0 | x | 90.0      | x | 2.4 | 5.51  | x | 3.54  | x | 0.094 |
| 3-100-340-43-000       | FM2678MP        | STEEL                | -----             | 44              | INT TH  | 162.0 | x | 105.0     | x | 2.3 | 6.38  | x | 4.13  | x | 0.091 |
| 3-100-340-47-000       | FM2682MP        | STEEL                | -----             | 41              | INT TH  | 178.0 | x | 119.0     | x | 2.3 | 7.01  | x | 4.69  | x | 0.091 |
| 3-100-340-55-001       | FM4332MP        | STEEL                | -----             | 48              | INT TH  | 225.0 | x | 140.0     | x | 3.0 | 8.86  | x | 5.51  | x | 0.118 |
| 3-100-340-75-000       | FM8986MP        | STEEL                | SINEWAVED         | 68              | INT TH  | 380.0 | x | 268.0     | x | 4.0 | 14.96 | x | 10.55 | x | 0.157 |
| 3-100-610-31-005       | FM3785          | BRONZE               | SPIRAL            | 32              | EXT TH  | 133.2 | x | 91.0      | x | 2.4 | 5.24  | x | 3.58  | x | 0.094 |
| 3-100-610-39-008       | FM3415          | BRONZE               | SPR/RAD           | 36              | EXT TH  | 151.2 | x | 102.0     | x | 2.4 | 5.95  | x | 4.02  | x | 0.094 |

| REPLACES OEM PT.NO. |             | FMC PART NO. | MATERIAL         | GROOVE DETAILS | TEETH/TANGS | SIZE MM   |       |   | SIZE INCH |   |      |       |   |       |   |       |
|---------------------|-------------|--------------|------------------|----------------|-------------|-----------|-------|---|-----------|---|------|-------|---|-------|---|-------|
| <b>PANHARD</b>      |             |              |                  |                |             |           |       |   |           |   |      |       |   |       |   |       |
|                     | 14706       | FM3474MP     | STEEL            | -----          | 4           | EXT LG    | 85.0  | x | 49.2      | x | 1.5  | 3.35  | x | 1.94  | x | 0.059 |
|                     | 14707       | FM2969       | BRONZE           | WAFFLE         | 22          | INT TH    | 71.7  | x | 44.0      | x | 1.6  | 2.82  | x | 1.73  | x | 0.063 |
| <b>P&amp;H</b>      |             |              |                  |                |             |           |       |   |           |   |      |       |   |       |   |       |
|                     | 1015Z834    | FM4992MP     | STEEL            | -----          | 39          | EXT TH    | 126.2 | x | 92.0      | x | 0.8  | 4.97  | x | 3.62  | x | 0.031 |
|                     | 1015Z1006   | FM1279       | PAPER            | 2 PASS         | 52          | INT TH    | 148.6 | x | 107.7     | x | 1.8  | 5.85  | x | 4.24  | x | 0.07  |
|                     | 1015Z1305   | FM1279       | PAPER            | 2 PASS         | 52          | INT TH    | 148.6 | x | 107.7     | x | 1.8  | 5.85  | x | 4.24  | x | 0.07  |
|                     | 1018Z3302   | FM4989       | PAPER            | 2 PASS         | 39          | INT TH    | 119.0 | x | 78.4      | x | 2.3  | 4.68  | x | 3.09  | x | 0.09  |
|                     | 1018Z4530   | FM1216MP     | STEEL            | -----          | 60          | EXT TH    | 154.2 | x | 113.8     | x | 1.8  | 6.07  | x | 4.48  | x | 0.07  |
| <b>PERLINI</b>      |             |              |                  |                |             |           |       |   |           |   |      |       |   |       |   |       |
|                     | 210500356   | FM7987       | PAPER            | 3 PASS         | 98          | INT TH    | 714.7 | x | 483.2     | x | 5.1  | 28.14 | x | 19.02 | x | 0.2   |
| <b>PETTIBONE</b>    |             |              |                  |                |             |           |       |   |           |   |      |       |   |       |   |       |
|                     | 40560-28    | FM1900MP     | STEEL            | -----          | 64          | EXT TH    | 205.5 | x | 145.3     | x | 1.7  | 8.09  | x | 5.72  | x | 0.067 |
|                     | 40560-3     | FM1247OE     | BRONZE           | SUNBURST       | 43          | (44)IN TH | 196.9 | x | 137.7     | x | 2.8  | 7.75  | x | 5.42  | x | 0.109 |
|                     | 40560-9     | FM1247OE     | BRONZE           | SUNBURST       | 43          | (44)IN TH | 196.9 | x | 137.7     | x | 2.8  | 7.75  | x | 5.42  | x | 0.109 |
|                     | 44238-64    | FM5452MP     | STEEL            | END PLATE      | 54          | EXT TH    | 139.2 | x | 98.2      | x | 8.7  | 5.48  | x | 3.87  | x | 0.343 |
|                     | 44238-65    | FM2465       | PAPER            | 1 PASS         | 43          | (45)IN TH | 133.1 | x | 92.7      | x | 1.6  | 5.24  | x | 3.65  | x | 0.063 |
|                     | 44238-66    | FM1324MP     | STEEL            | -----          | 54          | EXT TH    | 139.2 | x | 98.6      | x | 1.8  | 5.48  | x | 3.88  | x | 0.07  |
|                     | 44238-67    | FM5442MP     | STEEL            | END PLATE      | 54          | EXT TH    | 139.2 | x | 98.2      | x | 8.3  | 5.48  | x | 3.87  | x | 0.327 |
|                     | 44238-80    | FM1933       | BRONZE           | RADIAL         | 59          | INT TH    | 190.8 | x | 147.3     | x | 3.0  | 7.51  | x | 5.8   | x | 0.118 |
|                     | 44238-81    | FM1938MP     | STEEL            | -----          | 3           | EXT LG    | 214.9 | x | 155.7     | x | 1.8  | 8.46  | x | 6.13  | x | 0.07  |
|                     | 44367-9     | FM2829       | PAPER            | 2 PASS         | 45          | INT TH    | 133.1 | x | 92.7      | x | 2.1  | 5.24  | x | 3.65  | x | 0.083 |
|                     | 44367-10    | FM3650MP     | STEEL            | -----          | 54          | EXT TH    | 139.2 | x | 98.6      | x | 3.0  | 5.48  | x | 3.88  | x | 0.118 |
|                     | 9449009     | FM3346MP     | STEEL            | -----          | 54          | EXT TH    | 139.2 | x | 98.6      | x | 2.5  | 5.48  | x | 3.88  | x | 0.1   |
|                     | LL-7160-301 | FM3414MP     | END PLATE        | -----          | 32          | (64)EX TH | 230.0 | x | 152.5     | x | 10.8 | 9.06  | x | 6.0   | x | 0.397 |
|                     | LL-7160-302 | FM2823       | PAPER            | 2 PASS         | 36          | INT TH    | 223.0 | x | 71.0      | x | 4.9  | 8.78  | x | 2.8   | x | 0.191 |
|                     | LL-7160-516 | FM3667       | PAPER            | 2 PASS         | 44          | INT TH    | 196.9 | x | 138.0     | x | 2.8  | 7.75  | x | 5.43  | x | 0.11  |
|                     | LL-7160-525 | FM2825       | BRONZE           | SUNBURST       | 45          | INT TH    | 133.0 | x | 93.0      | x | 1.8  | 5.24  | x | 3.66  | x | 0.069 |
| <b>POCLAIN</b>      |             |              |                  |                |             |           |       |   |           |   |      |       |   |       |   |       |
|                     | 004739337D  | FM5061       | BRONZE           | WAFFLE         | 18          | INT TH    | 128.3 | x | 90.2      | x | 1.9  | 5.05  | x | 3.55  | x | 0.075 |
|                     | 004739338E  | FM5064MP     | STEEL            | -----          | 26          | EXT TH    | 138.0 | x | 102.0     | x | 1.2  | 5.43  | x | 4.02  | x | 0.047 |
| <b>PPM</b>          |             |              |                  |                |             |           |       |   |           |   |      |       |   |       |   |       |
|                     | A8143127    | FM5333       | BRONZE           | WAFFLE         | 37          | EXT TH    | 75.5  | x | 57.2      | x | 1.7  | 2.97  | x | 2.25  | x | 0.065 |
|                     | B8143128    | FM5336MP     | STEEL            | -----          | 27          | INT TH    | 71.2  | x | 52.5      | x | 1.1  | 2.8   | x | 2.07  | x | 0.043 |
|                     | 5370650724  | FM2184MP     | STEEL            | -----          | 3           | EXT SL    | 201.7 | x | 129.5     | x | 2.7  | 7.94  | x | 5.1   | x | 0.106 |
|                     | 5370650725  | FM2181       | BRONZE           | SUNBURST       | 19          | INT TH    | 177.8 | x | 34.3      | x | 4.8  | 7.0   | x | 1.35  | x | 0.189 |
|                     | 5370651185  | FM2890MP     | STEEL            | -----          | 3           | EXT LG    | 180.0 | x | 111.0     | x | 2.7  | 7.09  | x | 4.37  | x | 0.105 |
|                     | 5370651789  | FM4606MP     | STEEL            | -----          | 3           | EXT LG    | 216.9 | x | 144.0     | x | 2.7  | 8.54  | x | 5.67  | x | 0.106 |
|                     | 5370651794  | FM4625       | PAPER            | SUNBURST       | 16          | INT TH    | 201.0 | x | 40.5      | x | 4.9  | 7.91  | x | 1.59  | x | 0.192 |
|                     | 5370651822  | FM5407       | MOLYBDENUM       | RADIAL         | 34          | INT TH    | 109.8 | x | 66.0      | x | 1.3  | 4.32  | x | 2.6   | x | 0.052 |
|                     | 5370651824  | FM6922MP     | STEEL            | HARDENED       | 4           | EXT LG    | 122.6 | x | 72.2      | x | 1.8  | 4.83  | x | 2.84  | x | 0.071 |
|                     | 5370651825  | FM5409       | MOLYBDENUM/STEEL | RADIAL         | 34          | INT TH    | 109.8 | x | 66.0      | x | 2.9  | 4.32  | x | 2.6   | x | 0.112 |



| REPLACES<br>OEM PT.NO. | FMC<br>PART NO. | MATERIAL | GROOVE<br>DETAILS | TEETH/<br>TANGS | SIZE MM   |       |   | SIZE INCH |   |     |       |   |      |   |       |
|------------------------|-----------------|----------|-------------------|-----------------|-----------|-------|---|-----------|---|-----|-------|---|------|---|-------|
| 5370651880             | FM2344MP        | STEEL    | -----             | 6               | EXT LG    | 220.0 | x | 145.5     | x | 2.7 | 8.66  | x | 5.73 | x | 0.105 |
| 5370652194             | FM6977          | PAPER    | WAFFLE            | 54              | INT TH    | 178.0 | x | 105.6     | x | 3.8 | 7.01  | x | 4.16 | x | 0.148 |
| 5370652413             | FM6980MP        | STEEL    | -----             | 4               | EXT LG    | 199.7 | x | 114.0     | x | 3.7 | 7.86  | x | 4.49 | x | 0.146 |
| 5370652542             | FM6127          | PAPER    | WAFFLE            | 24              | INT TH    | 253.0 | x | 69.0      | x | 6.1 | 9.96  | x | 2.72 | x | 0.24  |
| 5370652544             | FM6130MP        | STEEL    | -----             | 3               | EXT LG    | 268.0 | x | 176.0     | x | 4.5 | 10.55 | x | 6.93 | x | 0.177 |
| 5904646721             | FM3575          | PAPER    | 3 PASS            | 35              | INT TH    | 179.0 | x | 103.0     | x | 3.5 | 7.05  | x | 4.05 | x | 0.138 |
| 5904658567             | FM4766TW        | STEEL    | HARDENED          |                 | WASHER    | 46.0  | x | 26.2      | x | 1.0 | 1.81  | x | 1.03 | x | 0.039 |
| <b>PRM NEWAGE</b>      |                 |          |                   |                 |           |       |   |           |   |     |       |   |      |   |       |
| MT731                  | FM2651          | BRONZE   | WAFFLE            | 17              | INT TH    | 71.4  | x | 34.0      | x | 1.6 | 2.81  | x | 1.34 | x | 0.063 |
| MT725                  | FM2871          | BRONZE   | WAFFLE            | 24              | INT TH    | 88.9  | x | 49.1      | x | 1.6 | 3.5   | x | 1.93 | x | 0.063 |
| FM3209                 | FM3209          | BRONZE   | WAFFLE            | 20              | INT TH    | 112.8 | x | 60.5      | x | 2.2 | 4.44  | x | 2.38 | x | 0.085 |
| FM3182MP               | FM3182MP        | STEEL    | -----             | 9               | EXT SL    | 114.0 | x | 57.0      | x | 1.6 | 4.49  | x | 2.24 | x | 0.063 |
| MT982                  | FM3184MP        | STEEL    | -----             | 17              | (33)EX TH | 99.6  | x | 57.0      | x | 1.6 | 3.92  | x | 2.24 | x | 0.063 |
| MT116                  | FM3186MP        | STEEL    | -----             | 9               | EXT SL    | 95.2  | x | 46.0      | x | 1.6 | 3.75  | x | 1.81 | x | 0.063 |

| REPLACES OEM PT.NO. | FMC PART NO. | MATERIAL | GROOVE DETAILS | TEETH/TANGS | SIZE MM |  |  |  | SIZE INCH |  |  |  |
|---------------------|--------------|----------|----------------|-------------|---------|--|--|--|-----------|--|--|--|
|---------------------|--------------|----------|----------------|-------------|---------|--|--|--|-----------|--|--|--|

### REINTJES

|             |          |        |         |    |        |       |   |       |   |     |      |   |      |   |       |
|-------------|----------|--------|---------|----|--------|-------|---|-------|---|-----|------|---|------|---|-------|
| K22-BGA 180 | FM4330MP | STEEL  | -----   | 38 | INT TH | 140.0 | x | 90.0  | x | 2.4 | 5.51 | x | 3.54 | x | 0.094 |
| K23-BGA 180 | FM3415   | BRONZE | SPR/RAD | 36 | EXT TH | 151.2 | x | 102.0 | x | 2.4 | 5.95 | x | 4.02 | x | 0.094 |

### RENAULT TRACTOR

|               |          |        |        |    |        |       |   |       |   |     |       |   |      |   |       |
|---------------|----------|--------|--------|----|--------|-------|---|-------|---|-----|-------|---|------|---|-------|
| 60.00.101.693 | FM2971   | BRONZE | WAFFLE | 22 | INT TH | 71.7  | x | 44.0  | x | 2.8 | 2.82  | x | 1.73 | x | 0.11  |
| 60.00.101.694 | FM3474MP | STEEL  | -----  | 4  | EXT LG | 85.0  | x | 49.2  | x | 1.5 | 3.35  | x | 1.94 | x | 0.059 |
| 60.00.101.695 | FM2969   | BRONZE | WAFFLE | 22 | INT TH | 71.7  | x | 44.0  | x | 1.6 | 2.82  | x | 1.73 | x | 0.063 |
| 77.00.014.997 | FM9009   | PAPER  | 2 PASS | 36 | INT TH | 205.0 | x | 38.6  | x | 4.8 | 8.07  | x | 1.52 | x | 0.189 |
| 77.00.015.006 | FM4651   | PAPER  | WAFFLE | 46 | INT TH | 223.0 | x | 48.0  | x | 4.8 | 8.78  | x | 1.89 | x | 0.189 |
| 77.00.016.494 | FM8907   | PAPER  | WAFFLE | 37 | INT HT | 165.1 | x | 38.6  | x | 4.8 | 6.5   | x | 1.52 | x | 0.189 |
| 77.00.016.511 | FM8574MP | STEEL  | -----  | 4  | EXT LG | 184.0 | x | 119.5 | x | 3.0 | 7.24  | x | 4.7  | x | 0.118 |
| 77.00.035.960 | FM7265   | PAPER  | WAFFLE | 38 | INT TH | 167.0 | x | 111.7 | x | 3.3 | 6.57  | x | 4.4  | x | 0.13  |
| 77.00.037.434 | FM7265   | PAPER  | WAFFLE | 38 | INT TH | 167.0 | x | 111.7 | x | 3.3 | 6.57  | x | 4.4  | x | 0.13  |
| 77.00.055.217 | FM4651   | PAPER  | WAFFLE | 46 | INT TH | 223.0 | x | 48.0  | x | 4.8 | 8.78  | x | 1.89 | x | 0.189 |
| 77.00.063.962 | FM7505   | PAPER  | 4 PASS | 14 | INT TH | 354.0 | x | 70.0  | x | 5.0 | 13.94 | x | 2.76 | x | 0.197 |

### RENAULT TRUCK

|            |          |           |        |    |        |       |   |       |   |     |      |   |      |   |       |
|------------|----------|-----------|--------|----|--------|-------|---|-------|---|-----|------|---|------|---|-------|
| 5001843336 | FM9354MP | STEEL     | -----  | 8  | EXT LG | 161.6 | x | 107.0 | x | 1.8 | 6.36 | x | 4.21 | x | 0.071 |
| 5001843337 | FM9351   | CARBON PA | 2 PASS | 34 | INT TH | 146.7 | x | 99.7  | x | 2.1 | 5.78 | x | 3.93 | x | 0.083 |

### ROCKWELL/ AXLETECH/ MERITOR

|               |          |          |          |    |           |       |   |       |   |     |       |   |       |   |       |
|---------------|----------|----------|----------|----|-----------|-------|---|-------|---|-----|-------|---|-------|---|-------|
| 068120-2      | FM9078MP | STEEL    | -----    | 3  | EXT LG    | 246.5 | x | 162.3 | x | 3.8 | 9.7   | x | 6.39  | x | 0.15  |
| 313017        | FM2317   | OBSOLETE | 3 PASS   | 42 | INT TH    | 317.0 | x | 173.7 | x | 4.2 | 12.48 | x | 6.84  | x | 0.165 |
| 1036137       | FM7226MP | STEEL    | -----    | 3  | EXT SL    | 247.0 | x | 162.0 | x | 3.4 | 9.72  | x | 6.38  | x | 0.134 |
| 1036137       | FM7223   | PAPER    | WAFFLE   | 24 | INT TH    | 228.5 | x | 60.0  | x | 3.2 | 9.0   | x | 2.36  | x | 0.126 |
| 3281-N-1184   | FM4726MP | STEEL    | -----    | 46 | EXT TH    | 241.1 | x | 161.7 | x | 3.8 | 9.49  | x | 6.37  | x | 0.15  |
| 3281-P-42     | FM4642MP | STEEL    | -----    | 72 | (90)EX TH | 462.0 | x | 350.0 | x | 5.0 | 18.19 | x | 13.78 | x | 0.197 |
| 3281-W-23     | FM1326MP | STEEL    | -----    | 72 | (90)EX TH | 462.0 | x | 350.0 | x | 3.5 | 18.19 | x | 13.78 | x | 0.138 |
| 3281-X-24     | FM5086MP | STEEL    | -----    | 60 | (68)EX TH | 350.0 | x | 260.0 | x | 3.0 | 13.78 | x | 10.24 | x | 0.118 |
| 3281-Z-1144   | FM6547OE | PAPER    | WAFFLE   | 14 | INT TH    | 228.0 | x | 48.0  | x | 3.2 | 8.98  | x | 1.89  | x | 0.126 |
| 3281-Z-1144   | FM6547   | P206     | WAFFLE   | 14 | INT TH    | 228.0 | x | 48.0  | x | 3.2 | 8.98  | x | 1.89  | x | 0.126 |
| 3281-Z-1196   | FM8351   | AFP      | WAFFLE   | 43 | (49)IN TH | 360.0 | x | 202.7 | x | 5.3 | 14.17 | x | 7.98  | x | 0.209 |
| 328101013E    | FM6093   | AFP      | WAFFLE   | 60 | INT TH    | 450.0 | x | 300.0 | x | 5.3 | 17.72 | x | 11.81 | x | 0.209 |
| 328101016E    | FM4723   | PAPER    | WAF/RAD  | 22 | INT TH    | 228.6 | x | 66.8  | x | 3.2 | 9.0   | x | 2.63  | x | 0.125 |
| 328101019E    | FM3045   | AFP      | 2 PASS   | 39 | INT TH    | 338.7 | x | 193.0 | x | 4.5 | 13.34 | x | 7.6   | x | 0.175 |
| 328101020E    | FM8351   | AFP      | WAFFLE   | 43 | (49)IN TH | 360.0 | x | 202.7 | x | 5.3 | 14.17 | x | 7.98  | x | 0.209 |
| 3281G1203     | FM8354MP | STEEL    | -----    | 8  | EXT LG    | 389.7 | x | 220.0 | x | 4.6 | 15.34 | x | 8.66  | x | 0.179 |
| A-3213-K-37   | FM2887   | OBSOLETE | 2 PASS   | 60 | INT TH    | 450.0 | x | 300.0 | x | 5.3 | 17.72 | x | 11.81 | x | 0.209 |
| A-3281-K-37   | FM3167   | GRAPHITE | WAFFLE   | 60 | INT TH    | 450.0 | x | 300.0 | x | 5.3 | 17.72 | x | 11.81 | x | 0.209 |
| A-3281-S-19   | FM1259   | GRAPHITE | WAFFLE   | 54 | INT TH    | 450.3 | x | 269.5 | x | 5.5 | 17.73 | x | 10.61 | x | 0.216 |
| A-3281-S-1189 | FM4723   | PAPER    | WAF/RAD  | 22 | INT TH    | 228.6 | x | 66.8  | x | 3.2 | 9.0   | x | 2.63  | x | 0.125 |
| A-3281-Y-25   | FM3045   | AFP      | 2 PASS   | 39 | INT TH    | 338.7 | x | 193.0 | x | 4.5 | 13.34 | x | 7.6   | x | 0.175 |
| A3281Y1247    | FM6093   | AFP      | WAFFLE   | 60 | INT TH    | 450.0 | x | 300.0 | x | 5.3 | 17.72 | x | 11.81 | x | 0.209 |
| C-305193      | FM1262MP | STEEL    | -----    | 8  | EXT LG    | 142.5 | x | 99.1  | x | 1.6 | 5.61  | x | 3.9   | x | 0.063 |
| C-317753-X1   | FM1359   | BRONZE   | SPIRAL   | 45 | INT TH    | 133.1 | x | 92.7  | x | 1.6 | 5.24  | x | 3.65  | x | 0.063 |
| C-317754-X1   | FM2379   | BRONZE   | SUNBURST | 29 | INT TH    | 168.1 | x | 119.3 | x | 2.5 | 6.62  | x | 4.7   | x | 0.1   |

| REPLACES<br>OEM PT.NO. | FMC<br>PART NO. | MATERIAL | GROOVE<br>DETAILS | TEETH/<br>TANGS | SIZE MM |       |   |       | SIZE INCH |     |       |   |      |   |       |
|------------------------|-----------------|----------|-------------------|-----------------|---------|-------|---|-------|-----------|-----|-------|---|------|---|-------|
| C-317756-X1            | FM1687          | BRONZE   | SUNBURST          | 34              | INT TH  | 198.1 | x | 140.5 | x         | 2.5 | 7.8   | x | 5.53 | x | 0.1   |
| CL-11-551-3            | FM3014MP        | STEEL    | -----             | 83              | EXT TH  | 355.0 | x | 238.4 | x         | 6.3 | 13.98 | x | 9.38 | x | 0.247 |
| UCL-16-11553           | FM3011          | PAPER    | 2 PASS            | 53              | INT TH  | 342.9 | x | 220.5 | x         | 5.2 | 13.5  | x | 8.68 | x | 0.204 |
| 84660408               | FM6081          | OBSOLETE | 2 PASS            | 50              | INT TH  | 400.0 | x | 245.6 | x         | 5.0 | 15.75 | x | 9.67 | x | 0.197 |



| REPLACES<br>OEM PT.NO.              | FMC<br>PART NO. | MATERIAL             | GROOVE<br>DETAILS | TEETH/<br>TANGS | SIZE MM | SIZE INCH                                |
|-------------------------------------|-----------------|----------------------|-------------------|-----------------|---------|--|
| <b>SAME/ LAMBORGHINI/ HURLIMANN</b> |                 |                      |                   |                 |         |  |
| 0.007.2683.0                        | TBA             | OBSOLETE             | -----             |                 | EXT LG  | 228.0 x 140.0 x 2.7 8.98 x 5.51 x 0.104  |
| 0.007.3191.0/10                     | TBA             | OBSOLETE             | SUNBURST          | 34              | INT TH  | 224.0 x 98.0 x 4.9 8.82 x 3.86 x 0.193   |
| 0.007.2688.0                        | FM7606MP        | OBSOLETE             | -----             | 15              | INT TH  | 173.0 x 44.0 x 3.5 6.81 x 1.73 x 0.138   |
| 0.007.7597.0/10                     | FM8588MP        | STEEL                | -----             | 60              | INT TH  | 254.0 x 176.0 x 3.0 10.0 x 6.93 x 0.118  |
| 0.008.4255.0                        | FM6950MP        | STEEL                | -----             | 19              | INT TH  | 145.0 x 59.0 x 3.5 5.71 x 2.32 x 0.138   |
| 0.008.4661.0                        | FM6866MP        | GRAPHITE             | SUNBURST          | 27              | INT TH  | 224.0 x 55.0 x 7.0 8.82 x 2.17 x 0.276   |
| 0.008.4662.0                        | TBA             | OBSOLETE             | -----             |                 | EXT LG  | 228.0 x 140.0 x 5.3 8.98 x 5.51 x 0.209  |
| 0.008.5079.2                        | FM9103          | OBSOLETE             | -----             | 58              | INT TH  | 168.0 x 116.0 x 3.5 6.61 x 4.57 x 0.138  |
| 0.008.5173.2                        | FM8703          | GRAPHITE             | SUNBURST          | 12              | INT TH  | 224.0 x 38.0 x 7.0 8.82 x 1.5 x 0.276    |
| 0.008.5191.0                        | FM7608MP        | OBSOLETE             | -----             | 15              | INT TH  | 130.0 x 44.0 x 2.0 5.12 x 1.73 x 0.079   |
| 0.008.5267.2                        | FM7609          | PAPER                | WAFFLE            | 12              | INT TH  | 224.0 x 34.0 x 7.0 8.82 x 1.34 x 0.276   |
| 0.008.5343.2                        | FM4069          | GRAPHITE             | SUNBURST          | 15              | INT TH  | 178.0 x 44.0 x 5.0 7.01 x 1.73 x 0.197   |
| 0.008.7262.3/10                     | FM6943          | GRAPHITE             | SUNBURST          | 22              | INT TH  | 143.0 x 41.0 x 4.9 5.63 x 1.61 x 0.193   |
| 0.009.7066.2                        | FM6945          | CARBON PA            | SUNBURST          | 13              | INT TH  | 282.0 x 46.5 x 7.0 11.1 x 1.83 x 0.276   |
| 0.009.7067.2                        | FM6867          | GRAPHITE             | SUNBURST          | 12              | INT TH  | 282.0 x 46.5 x 7.0 11.1 x 1.83 x 0.276   |
| 0.011.0587.2                        | FM8865          | CARBON PA            | WAFFLE            | 12              | INT TH  | 223.6 x 38.1 x 6.8 8.8 x 1.5 x 0.267     |
| 0.011.3765.0                        | FM7955          | PAPER                | WAFFLE            | 12              | INT TH  | 282.0 x 46.5 x 7.1 11.1 x 1.83 x 0.28    |
| 0.013.9453.0                        | FM9004MP        | STEEL                | -----             | 6               | EXT TH  | 135.6 x 101.2 x 1.8 5.34 x 3.98 x 0.069  |
| 0.015.4482.2                        | FM8865          | CARBON PA            | WAFFLE            | 12              | INT TH  | 223.6 x 38.1 x 6.8 8.8 x 1.5 x 0.267     |
| 0.015.6021.2                        | FM7609          | PAPER                | WAFFLE            | 12              | INT TH  | 224.0 x 34.0 x 7.0 8.82 x 1.34 x 0.276   |
| 0.151.5469.0                        | TBA             | OBSOLETE             | SUNBURST          | 23              | INT TH  | 101.0 x 28.0 x 5.2 3.98 x 1.1 x 0.205    |
| 0.151.5468.0                        | TBA             | OBSOLETE             | -----             |                 | EXT LG  | 108.0 x 50.0 x 2.7 4.25 x 1.97 x 0.104   |
| 0.154.5459.0/01                     | FM1707          | BRONZE               | SPR/WAG           | 27              | INT TH  | 224.0 x 55.1 x 4.8 8.82 x 2.17 x 0.19    |
| 0.154.5459.0/13                     | FM4655          | GRAPHITE             | SUNBURST          | 27              | INT TH  | 224.0 x 55.0 x 4.8 8.82 x 2.17 x 0.189   |
| 0.154.5460.0/01                     | FM1204MP        | STEEL                | -----             | 1               | EXT LG  | 228.6 x 127.0 x 2.7 9.0 x 5.0 x 0.106    |
| 0.154.5460.0/14                     | FM3222MP        | STEEL                | -----             | 1               | EXT LG  | 228.6 x 127.0 x 2.7 9 x 5 x 0.106        |
| 0.163.3654.0                        | FM1341B         | BRONZE               | SPR/RAD           | 52              | INT TH  | 148.6 x 107.4 x 2.3 5.85 x 4.23 x 0.09   |
| 0.163.3655.0                        | FM1216MP        | STEEL                | -----             | 60              | EXT TH  | 154.2 x 113.8 x 1.8 6.07 x 4.48 x 0.07   |
| 0.164.3642.0                        | FM1657B         | BRONZE               | SPR/RAD           | 45              | INT TH  | 133.4 x 92.7 x 2.1 5.25 x 3.65 x 0.082   |
| 0.164.3643.0                        | FM1324MP        | STEEL                | -----             | 54              | EXT TH  | 139.2 x 98.6 x 1.8 5.48 x 3.88 x 0.07    |
| 0.170.5434.0/12                     | FM2103          | GRAPHITE             | SUN/RAD           | 12              | INT TH  | 304.0 x 51.0 x 10.0 11.97 x 2.01 x 0.394 |
| 0.171.5434.0                        | FM6465          | GRAPHITE             | SUNBURST          | 12              | INT TH  | 260.0 x 51.0 x 10.0 10.24 x 2.01 x 0.394 |
| 0.171.5457.0                        | TBA             | OBSOLETE             | -----             | 26              | INT TH  | 170.0 x 64.0 x 3.5 6.69 x 2.52 x 0.138   |
| 0.171.5475.0                        | TBA             | OBSOLETE             | -----             |                 | EXT LG  | 184.0 x 114.0 x 2.6 7.24 x 4.49 x 0.102  |
| 0.188.5434.0/02                     | FM7611          | CARBON PA            | SUNBURST          | 12              | INT TH  | 342.0 x 58.0 x 10.0 13.46 x 2.28 x 0.394 |
| 0.188.5458.0                        | FM7720MP        | OBSOLETE AFTER STOCK |                   | 26              | INT TH  | 185.0 x 64.0 x 3.5 7.28 x 2.52 x 0.138   |
| 0.194.5464.2                        | 940045          | GRAPHITE             | SUNBURST          | 13              | INT TH  | 178.0 x 38.0 x 5.2 7.01 x 1.5 x 0.205    |
| 0.194.5465.0                        | FM8498MP        | STEEL                | -----             |                 | EXT LG  | 184.0 x 128.0 x 2.7 7.24 x 5.04 x 0.104  |
| 0.224.5434.0                        | FM1707          | BRONZE               | -----             | 27              | INT TH  | 224.0 x 55.0 x 4.8 8.82 x 2.17 x 0.189   |
| 0.224.5464.0                        | TBA             | OBSOLETE             | -----             | 25              | INT TH  | 165.0 x 104.0 x 2.0 6.5 x 4.09 x 0.079   |
| 0.255.3936.0                        | FM9004MP        | STEEL                | -----             | 6               | EXT TH  | 135.6 x 101.2 x 1.8 5.34 x 3.98 x 0.069  |
| 0.255.3970.2                        | FM5083          | GRAPHITE             | SUNBURST          | 48              | INT TH  | 124.0 x 97.3 x 2.5 4.88 x 3.83 x 0.098   |
| 0.255.5447.2/10                     | FM6945          | CARBON PA            | SUNBURST          | 13              | INT TH  | 282.0 x 46.5 x 7.0 11.1 x 1.83 x 0.276   |
| 0.255.5452.0                        | FM6950MP        | STEEL                | -----             | 19              | INT TH  | 145.0 x 59.0 x 3.5 5.71 x 2.32 x 0.138   |
| 0.256.5434.0/10                     | FM4797          | GRAPHITE             | SUNBURST          | 23              | INT TH  | 178.0 x 44.0 x 5.0 7.01 x 1.73 x 0.197   |
| 0.256.5456.0                        | FM3844MP        | STEEL                | -----             | 1               | EXT LG  | 184.0 x 114.0 x 2.6 7.24 x 4.49 x 0.102  |
| 0.270.4351.0                        | FM7592MP        | OBSOLETE             | -----             | 2               | EXT LG  | 181.0 x 100.0 x 2.5 7.13 x 3.94 x 0.098  |

| REPLACES OEM PT.NO. | FMC PART NO. | MATERIAL | GROOVE DETAILS | TEETH/TANGS | SIZE MM |       |   | SIZE INCH |   |     |       |   |      |   |       |
|---------------------|--------------|----------|----------------|-------------|---------|-------|---|-----------|---|-----|-------|---|------|---|-------|
| 0.275.4351.0        | FM6948MP     | STEEL    | -----          | 2           | EXT LG  | 228.0 | x | 140.0     | x | 2.5 | 8.98  | x | 5.51 | x | 0.098 |
| 0.292.5714.0/10     | FM6679       | GRAPHITE | SUNBURST       | 87          | EXT TH  | 264.0 | x | 206.0     | x | 3.5 | 10.39 | x | 8.11 | x | 0.138 |
| 0.292.5715.0        | FM6260MP     | STEEL    | -----          | 62          | INT TH  | 254.0 | x | 194.0     | x | 2.0 | 10.0  | x | 7.64 | x | 0.079 |
| 0.445.5447.0        | FM6867       | GRAPHITE | SUNBURST       | 12          | INT TH  | 282.0 | x | 46.5      | x | 7.0 | 11.1  | x | 1.83 | x | 0.276 |
| 0.900.0116.1        | FM9485       | GRAPHITE | SUNBURST       | 12          | INT TH  | 170.0 | x | 32.7      | x | 4.8 | 6.69  | x | 1.29 | x | 0.189 |
| 0.900.0801.2        | FM8483       | GRAPHITE | SUNBURST       | 28          | INT TH  | 242.6 | x | 56.1      | x | 4.8 | 9.55  | x | 2.21 | x | 0.189 |

**SAMSUNG (also see Clark)**

|               |          |           |             |    |           |       |   |       |   |     |       |   |      |   |       |
|---------------|----------|-----------|-------------|----|-----------|-------|---|-------|---|-----|-------|---|------|---|-------|
| 3146763       | FM2991   | PAPER     | 3 PASS      | 57 | INT TH    | 360.0 | x | 237.0 | x | 4.5 | 14.17 | x | 9.33 | x | 0.177 |
| 419-15-12290L | FM4837   | RED PAPER | WAFFLE      | 26 | INT TH    | 160.0 | x | 97.5  | x | 2.2 | 6.3   | x | 3.84 | x | 0.087 |
| 419-15-12310L | FM2914MP | STEEL     | -----       | 68 | EXT TH    | 174.1 | x | 110.0 | x | 1.7 | 6.85  | x | 4.33 | x | 0.066 |
| 7114-32560    | FM3387   | PAPER     | 2 PASS      | 48 | INT TH    | 219.0 | x | 144.2 | x | 4.0 | 8.62  | x | 5.68 | x | 0.157 |
| 7123-22310    | FM5570MP | STEEL     | -----       | 77 | EXT TH    | 274.0 | x | 182.0 | x | 4.0 | 10.79 | x | 7.17 | x | 0.157 |
| 7124-22440    | FM2995   | PAPER     | 2 PASS      | 54 | INT TH    | 325.0 | x | 224.0 | x | 4.5 | 12.8  | x | 8.82 | x | 0.177 |
| 7124-22540    | FM3630MP | STEEL     | -----       | 75 | EXT TH    | 345.0 | x | 243.0 | x | 3.9 | 13.58 | x | 9.57 | x | 0.154 |
| 7124-22550    | FM3632MP | STEEL     | -----       | 75 | EXT TH    | 345.0 | x | 243.0 | x | 4.2 | 13.58 | x | 9.57 | x | 0.165 |
| 7124-22560    | FM3634MP | STEEL     | -----       | 75 | EXT TH    | 345.0 | x | 243.0 | x | 4.5 | 13.58 | x | 9.57 | x | 0.177 |
| 7124-22570    | FM3636MP | STEEL     | -----       | 75 | EXT TH    | 345.0 | x | 243.0 | x | 5.0 | 13.58 | x | 9.57 | x | 0.197 |
| 7124-22650    | FM7908MP | STEEL     | -----       | 75 | EXT TH    | 345.0 | x | 243.0 | x | 3.0 | 13.58 | x | 9.57 | x | 0.118 |
| 7124-22660    | FM4026MP | STEEL     | -----       | 75 | EXT TH    | 345.0 | x | 243.0 | x | 3.3 | 13.58 | x | 9.57 | x | 0.128 |
| 7124-22670    | FM7910MP | STEEL     | -----       | 75 | EXT TH    | 345.0 | x | 243.0 | x | 3.5 | 13.58 | x | 9.57 | x | 0.138 |
| 7124-22690    | FM4024MP | OBSOLETE  | -----       | 75 | EXT TH    | 345.0 | x | 243.0 | x | 2.5 | 13.58 | x | 9.57 | x | 0.098 |
| 7124-22700    | FM4028MP | STEEL     | -----       | 75 | EXT TH    | 345.0 | x | 243.0 | x | 3.8 | 13.58 | x | 9.57 | x | 0.148 |
| 7124-52490    | FM2991   | PAPER     | 3 PASS      | 57 | INT TH    | 360.0 | x | 237.0 | x | 4.5 | 14.17 | x | 9.33 | x | 0.177 |
| 7124-52500    | FM3620MP | STEEL     | -----       | 75 | EXT TH    | 383.0 | x | 253.0 | x | 3.9 | 15.08 | x | 9.96 | x | 0.154 |
| 7124-52510    | FM3622MP | STEEL     | -----       | 75 | EXT TH    | 383.0 | x | 253.0 | x | 4.3 | 15.08 | x | 9.96 | x | 0.167 |
| 7124-52520    | FM3624MP | STEEL     | -----       | 75 | EXT TH    | 383.0 | x | 253.0 | x | 4.5 | 15.08 | x | 9.96 | x | 0.177 |
| 7124-52530    | FM3626MP | STEEL     | -----       | 75 | EXT TH    | 383.0 | x | 253.0 | x | 5.0 | 15.08 | x | 9.96 | x | 0.197 |
| 7124-52650    | FM4020MP | STEEL     | -----       | 75 | EXT TH    | 383.0 | x | 253.0 | x | 3.3 | 15.08 | x | 9.96 | x | 0.128 |
| 7124-52660    | FM8784MP | STEEL     | -----       | 75 | EXT TH    | 383.0 | x | 253.0 | x | 3.5 | 15.08 | x | 9.96 | x | 0.138 |
| 7124-52670    | FM4022MP | STEEL     | -----       | 75 | EXT TH    | 383.0 | x | 253.0 | x | 3.8 | 15.08 | x | 9.96 | x | 0.148 |
| 7124-52680    | FM4018MP | STEEL     | -----       | 75 | EXT TH    | 383.0 | x | 253.0 | x | 2.5 | 15.08 | x | 9.96 | x | 0.098 |
| 7173-00820    | FM3377   | PAPER     | 2 PASS      | 62 | INT TH    | 204.0 | x | 152.7 | x | 3.7 | 8.03  | x | 6.01 | x | 0.148 |
| 7173-00830    | FM3380MP | STEEL     | -----       | 70 | (74)EX TH | 209.0 | x | 161.0 | x | 2.5 | 8.23  | x | 6.34 | x | 0.1   |
| 7173-01570    | FM3373   | PAPER     | 2 PASS      | 36 | INT TH    | 134.0 | x | 87.8  | x | 2.3 | 5.28  | x | 3.46 | x | 0.093 |
| 7173-01580    | FM3850MP | STEEL     | -----       | 56 | EXT TH    | 142.0 | x | 96.0  | x | 2.0 | 5.59  | x | 3.78 | x | 0.079 |
| 7173-01581    | FM3376MP | STEEL     | -----       | 6  | EX LG     | 152.5 | x | 95.0  | x | 2.0 | 6     | x | 3.74 | x | 0.079 |
| 7173-02140    | FM3382FP | STEEL     | FLEXI PLATE | 6  | HOLE      | 339.7 | x | 133.4 | x | 1.5 | 13.37 | x | 5.25 | x | 0.059 |
| 7173-04550    | FM2719   | PAPER     | 2 PASS      | 33 | INT TH    | 117.9 | x | 68.1  | x | 2.2 | 4.64  | x | 2.68 | x | 0.087 |
| ?             | FM4089   | PAPER     | 3 PASS      | 48 | INT TH    | 232.7 | x | 142.0 | x | 4.0 | 9.16  | x | 5.59 | x | 0.157 |

**SANDERSON**

|        |          |          |        |    |        |       |   |       |   |     |      |   |      |   |       |
|--------|----------|----------|--------|----|--------|-------|---|-------|---|-----|------|---|------|---|-------|
| 323994 | FM3824MP | STEEL    | -----  | 2  | EXT LG | 195.0 | x | 110.0 | x | 2.6 | 7.68 | x | 4.33 | x | 0.102 |
| 323995 | FM3103   | GRAPHITE | WAFFLE | 28 | INT TH | 169.0 | x | 56.0  | x | 4.8 | 6.65 | x | 2.21 | x | 0.189 |
| 500215 | FM3571   | PAPER    | 2 PASS | 59 | INT TH | 190.8 | x | 147.3 | x | 3.0 | 7.51 | x | 5.8  | x | 0.118 |
| 504651 | FM3035   | PAPER    | WAFFLE | 22 | INT TH | 204.5 | x | 53.3  | x | 4.8 | 8.05 | x | 2.1  | x | 0.189 |
| 504652 | FM3038MP | STEEL    | -----  | 1  | EXT SL | 236.0 | x | 85.0  | x | 2.7 | 9.29 | x | 3.35 | x | 0.106 |

| REPLACES OEM PT.NO.        |            | FMC PART NO. | MATERIAL  | GROOVE DETAILS | TEETH/TANGS |       | SIZE MM |       |   | SIZE INCH |       |   |      |   |       |
|----------------------------|------------|--------------|-----------|----------------|-------------|-------|---------|-------|---|-----------|-------|---|------|---|-------|
| 506010                     | FM2781     | GRAPHITE     | SUNBURST  | 15             | INT TH      | 213.0 | x       | 44.0  | x | 10.0      | 8.38  | x | 1.73 | x | 0.394 |
| 506931                     | FM1361     | BRONZE       | SUNBURST  | 45             | INT TH      | 133.1 | x       | 92.7  | x | 1.6       | 5.24  | x | 3.65 | x | 0.063 |
| <b>SCANIA</b>              |            |              |           |                |             |       |         |       |   |           |       |   |      |   |       |
| 174222                     | FM1049     | BRONZE       | SPR/RAD   | 62             | INT TH      | 254.0 | x       | 193.8 | x | 4.5       | 10    | x | 7.63 | x | 0.177 |
| 242040                     | FM1113     | BRONZE       | SPIRAL    | 69             | EXT TH      | 210.8 | x       | 142.2 | x | 3.2       | 8.3   | x | 5.6  | x | 0.125 |
| 284679                     | FM1049     | BRONZE       | SPR/RAD   | 62             | INT TH      | 254.0 | x       | 193.8 | x | 4.5       | 10    | x | 7.63 | x | 0.177 |
| 315346                     | FM5166MP   | STEEL        | -----     | 87             | EXT TH      | 263.5 | x       | 206.0 | x | 2.1       | 10.37 | x | 8.11 | x | 0.081 |
| 326019                     | FM1222MP   | STEEL        | -----     | 44             | INT TH      | 198.1 | x       | 125.7 | x | 3.0       | 7.8   | x | 4.95 | x | 0.118 |
| 342041                     | FM1222MP   | STEEL        | -----     | 44             | INT TH      | 198.1 | x       | 125.7 | x | 3.0       | 7.8   | x | 4.95 | x | 0.118 |
| 355402                     | FM1113     | BRONZE       | SPIRAL    | 69             | EXT TH      | 210.8 | x       | 142.2 | x | 3.2       | 8.3   | x | 5.6  | x | 0.125 |
| <b>SCHAEFF</b>             |            |              |           |                |             |       |         |       |   |           |       |   |      |   |       |
| 5904646721                 | FM3575     | PAPER        | 3 PASS    | 35             | INT TH      | 179.0 | x       | 103.0 | x | 3.5       | 7.05  | x | 4.05 | x | 0.138 |
| 5904658108                 | FM4089     | PAPER        | 3 PASS    | 48             | INT TH      | 232.7 | x       | 142.0 | x | 4.0       | 9.16  | x | 5.59 | x | 0.157 |
| 5904658211                 | FM6896MP   | STEEL        | -----     | 81             | EXT TH      | 243.6 | x       | 152.1 | x | 2.0       | 9.59  | x | 5.99 | x | 0.079 |
| 5904658212                 | FM4686MP   | STEEL        | -----     | 81             | EXT TH      | 243.6 | x       | 152.1 | x | 2.5       | 9.59  | x | 5.99 | x | 0.098 |
| 5904658213                 | FM6120-3.0 | STEEL        | -----     | 81             | EXT TH      | 243.5 | x       | 153.0 | x | 3.0       | 9.59  | x | 6.02 | x | 0.118 |
| 5904658262                 | FM3948MP   | STEEL        | -----     | 67             | (70)EX TH   | 191.0 | x       | 130.0 | x | 2.5       | 7.52  | x | 5.12 | x | 0.098 |
| 5904658263                 | FM3946MP   | STEEL        | -----     | 67             | (70)EX TH   | 191.0 | x       | 130.0 | x | 3.0       | 7.52  | x | 5.12 | x | 0.118 |
| 5904658505                 | FM4650MP   | STEEL        | -----     | 24             | EXT TH      | 108.2 | x       | 76.2  | x | 1.2       | 4.26  | x | 3.0  | x | 0.045 |
| 5904658624                 | FM4647     | BRONZE       | SPR/RAD   | 34             | INT TH      | 100.0 | x       | 68.2  | x | 1.6       | 3.94  | x | 2.69 | x | 0.061 |
| <b>SCHOPF</b>              |            |              |           |                |             |       |         |       |   |           |       |   |      |   |       |
| 33339                      | FM3594MP   | STEEL        | -----     | 29             | INT TH      | 131.1 | x       | 85.1  | x | 2.0       | 5.16  | x | 3.35 | x | 0.079 |
| 33748                      | FM3592MP   | STEEL        | -----     | 29             | INT TH      | 131.1 | x       | 85.1  | x | 1.5       | 5.16  | x | 3.35 | x | 0.059 |
| 37967                      | FM2962MP   | STEEL        | -----     | 37             | INT TH      | 204.6 | x       | 143.8 | x | 2.0       | 8.06  | x | 5.66 | x | 0.079 |
| 37968                      | FM2943     | BRONZE       | SPR/RAD   | 42             | EXT TH      | 212.5 | x       | 154.5 | x | 2.5       | 8.37  | x | 6.08 | x | 0.098 |
| 41462                      | FM2279     | BRONZE       | SUNBURST  | 35             | EXT TH      | 177.5 | x       | 109.0 | x | 2.0       | 6.99  | x | 4.29 | x | 0.079 |
| 41463                      | FM3602MP   | STEEL        | -----     | 35             | INT TH      | 170.9 | x       | 102.9 | x | 2.0       | 6.73  | x | 4.05 | x | 0.079 |
| 41465                      | FM3604MP   | STEEL        | -----     | 35             | INT TH      | 170.9 | x       | 102.9 | x | 2.5       | 6.73  | x | 4.05 | x | 0.098 |
| 44262                      | FM2279     | BRONZE       | SUNBURST  | 35             | EXT TH      | 177.5 | x       | 109.0 | x | 2.0       | 6.99  | x | 4.29 | x | 0.079 |
| 44263                      | FM3602MP   | STEEL        | -----     | 35             | INT TH      | 170.9 | x       | 102.9 | x | 2.0       | 6.73  | x | 4.05 | x | 0.079 |
| 44264                      | FM3604MP   | STEEL        | -----     | 35             | INT TH      | 170.9 | x       | 102.9 | x | 2.5       | 6.73  | x | 4.05 | x | 0.098 |
| 44266                      | FM2277     | BRONZE       | SUNBURST  | 27             | EXT TH      | 137.4 | x       | 90.9  | x | 2.0       | 5.41  | x | 3.58 | x | 0.079 |
| 44269                      | FM3594MP   | STEEL        | -----     | 29             | INT TH      | 131.1 | x       | 85.1  | x | 2.0       | 5.16  | x | 3.35 | x | 0.079 |
| 44270                      | FM3596MP   | STEEL        | -----     | 29             | INT TH      | 131.1 | x       | 85.1  | x | 2.5       | 5.16  | x | 3.35 | x | 0.098 |
| 75356                      | FM2279     | BRONZE       | SUNBURST  | 35             | EXT TH      | 177.5 | x       | 109.0 | x | 2.0       | 6.99  | x | 4.29 | x | 0.079 |
| 75357                      | FM4125     | BRONZE       | SUN-PLAIN | 35             | EXT TH      | 177.5 | x       | 109.0 | x | 1.6       | 6.99  | x | 4.29 | x | 0.063 |
| 75542                      | FM4123     | BRONZE       | SUN-PLAIN | 27             | EXT TH      | 137.4 | x       | 90.9  | x | 1.6       | 5.41  | x | 3.58 | x | 0.063 |
| <b>SELF CHANGING GEARS</b> |            |              |           |                |             |       |         |       |   |           |       |   |      |   |       |
| 52073                      | FM0371     | BRONZE       | -----     | 71             | EXT TH      | 181.4 | x       | 127.0 | x | 2.4       | 7.14  | x | 5.0  | x | 0.094 |
| <b>SENNENBOGEN</b>         |            |              |           |                |             |       |         |       |   |           |       |   |      |   |       |
| 15968                      | FM4650MP   | STEEL        | -----     | 24             | EXT TH      | 108.2 | x       | 76.2  | x | 1.2       | 4.26  | x | 3.0  | x | 0.045 |

| REPLACES<br>OEM PT.NO.                  | FMC<br>PART NO. | MATERIAL | GROOVE<br>DETAILS | TEETH/<br>TANGS | SIZE MM   |       |   |       | SIZE INCH |      |       |   |       |   |       |
|---|-----------------|----------|-------------------|-----------------|-----------|-------|---|-------|-----------|------|-------|---|-------|---|-------|
| 22961                                   | FM4933          | BRONZE   | WAF/WAG           | 45              | INT TH    | 187.0 | x | 132.6 | x         | 3.0  | 7.36  | x | 5.22  | x | 0.118 |
| 23946                                   | FM4089          | PAPER    | 3 PASS            | 48              | INT TH    | 232.7 | x | 142.0 | x         | 4.0  | 9.16  | x | 5.59  | x | 0.157 |
| 29261                                   | FM4844MP        | STEEL    | -----             | 67              | (70)EX TH | 191.0 | x | 130.0 | x         | 2.0  | 7.52  | x | 5.12  | x | 0.079 |
| 29262                                   | FM3948MP        | STEEL    | -----             | 67              | (70)EX TH | 191.0 | x | 130.0 | x         | 2.5  | 7.52  | x | 5.12  | x | 0.098 |
| 29263                                   | FM3946MP        | STEEL    | -----             | 67              | (70)EX TH | 191.0 | x | 130.0 | x         | 3.0  | 7.52  | x | 5.12  | x | 0.118 |
| 29264                                   | FM3575          | PAPER    | 3 PASS            | 35              | INT TH    | 179.0 | x | 103.0 | x         | 3.5  | 7.05  | x | 4.05  | x | 0.138 |
| 39934                                   | FM6896MP        | STEEL    | -----             | 81              | EXT TH    | 243.6 | x | 152.1 | x         | 2.0  | 9.59  | x | 5.99  | x | 0.079 |
| 39935                                   | FM4089          | PAPER    | 3 PASS            | 48              | INT TH    | 232.7 | x | 142.0 | x         | 4.0  | 9.16  | x | 5.59  | x | 0.157 |
| <b>SELICK</b>                           |                 |          |                   |                 |           |       |   |       |           |      |       |   |       |   |       |
| 260674                                  | FM2777          | GRAPHITE | SUNBURST          | 27              | INT TH    | 260.0 | x | 66.1  | x         | 10.0 | 10.24 | x | 2.6   | x | 0.394 |
| <b>SHINKO</b>                           |                 |          |                   |                 |           |       |   |       |           |      |       |   |       |   |       |
| 0614-30271-0                            | FM3239          | PAPER    | WAFFLE            | 34              | INT TH    | 167.6 | x | 105.0 | x         | 2.0  | 6.6   | x | 4.13  | x | 0.08  |
| <b>SISU</b>                             |                 |          |                   |                 |           |       |   |       |           |      |       |   |       |   |       |
| N2219018H                               | FM5167          | PAPER    | 3 PASS            | 63              | INT TH    | 435.0 | x | 252.0 | x         | 6.7  | 17.13 | x | 9.92  | x | 0.262 |
| N2220119H                               | FM5258MP        | STEEL    | -----             | 12              | EXT LG    | 453.0 | x | 298.0 | x         | 5.0  | 17.83 | x | 11.73 | x | 0.197 |
| 801904699                               | FM5578MP        | STEEL    | -----             | 96              | EXT TH    | 488.0 | x | 310.0 | x         | 4.0  | 19.21 | x | 12.2  | x | 0.157 |
| 802308777                               | FM1326MP        | STEEL    | -----             | 72              | (90)EX TH | 462.0 | x | 350.0 | x         | 3.5  | 18.19 | x | 13.78 | x | 0.138 |
| 802309501                               | FM6093          | AFP      | WAFFLE            | 60              | INT TH    | 450.0 | x | 300.0 | x         | 5.3  | 17.72 | x | 11.81 | x | 0.209 |
| 802310716                               | FM3007          | PAPER    | 3 PASS            | 60              | INT TH    | 466.0 | x | 284.0 | x         | 5.6  | 18.35 | x | 11.18 | x | 0.22  |
| 802311013                               | FM4349          | PAPER    | WAFFLE            | 42              | INT TH    | 340.0 | x | 206.0 | x         | 5.5  | 13.39 | x | 8.11  | x | 0.217 |
| 802311014                               | FM3006MP        | STEEL    | -----             | 70              | EXT TH    | 358.0 | x | 229.0 | x         | 5.0  | 14.09 | x | 9.02  | x | 0.197 |
| <b>SMV</b>                              |                 |          |                   |                 |           |       |   |       |           |      |       |   |       |   |       |
| 52768346                                | FM3007          | PAPER    | 3 PASS            | 60              | INT TH    | 466.0 | x | 284.0 | x         | 5.6  | 18.35 | x | 11.18 | x | 0.22  |
| <b>SOILMEC</b>                          |                 |          |                   |                 |           |       |   |       |           |      |       |   |       |   |       |
| ?                                       | FM5070MP        | STEEL    | -----             | 39              | INT TH    | 178.0 | x | 112.0 | x         | 2.2  | 7.01  | x | 4.41  | x | 0.086 |
| ?                                       | FM2679          | BRONZE   | SPR/RAD           | 62              | EXT TH    | 188.0 | x | 132.0 | x         | 2.4  | 7.4   | x | 5.2   | x | 0.094 |
| ?                                       | FM5519          | BRONZE   | WAFFLE            | 30              | INT TH    | 123.0 | x | 75.0  | x         | 2.2  | 4.84  | x | 2.95  | x | 0.087 |
| ?                                       | FM5522MP        | STEEL    | -----             | 6               | EXT LG    | 136.9 | x | 84.1  | x         | 1.5  | 5.39  | x | 3.31  | x | 0.059 |
| 680700040                               | FM4336MP        | STEEL    | -----             | 28              | INT TH    | 127.0 | x | 79.0  | x         | 1.8  | 5     | x | 3.11  | x | 0.071 |
| 680900040                               | FM2865          | BRONZE   | SUNBURST          | 64              | EXT TH    | 138.8 | x | 95.2  | x         | 2.8  | 5.46  | x | 3.75  | x | 0.11  |
| <b>SPICER (DANA, TURNER POWERTRAIN)</b> |                 |          |                   |                 |           |       |   |       |           |      |       |   |       |   |       |
| CKC64525                                | FM3261          | PAPER    | 2 PASS            | 40              | INT TH    | 127.1 | x | 82.2  | x         | 2.5  | 5     | x | 3.24  | x | 0.98  |
| CKC66118                                | FM1324MP        | STEEL    | -----             | 54              | EXT TH    | 139.2 | x | 98.6  | x         | 1.8  | 5.48  | x | 3.88  | x | 0.07  |
| CKC66409                                | FM2829          | PAPER    | 2 PASS            | 45              | INT TH    | 133.1 | x | 92.7  | x         | 2.1  | 5.24  | x | 3.65  | x | 0.083 |
| CKC67807                                | FM2629          | BRONZE   | 2 x RAD           | 45              | INT TH    | 133.1 | x | 92.7  | x         | 2.0  | 5.24  | x | 3.65  | x | 0.079 |
| CKC68632                                | FM3261          | PAPER    | 2 PASS            | 40              | INT TH    | 127.1 | x | 82.2  | x         | 2.5  | 5     | x | 3.24  | x | 0.98  |
| CKC68633                                | FM3264MP        | STEEL    | -----             | 26              | EXT TH    | 143.5 | x | 89.5  | x         | 2.2  | 5.65  | x | 3.52  | x | 0.084 |
| P18609                                  | FM1216MP        | STEEL    | -----             | 60              | EXT TH    | 154.2 | x | 113.8 | x         | 1.8  | 6.07  | x | 4.48  | x | 0.07  |
| P20602                                  | FM1279          | PAPER    | 2 PASS            | 52              | INT TH    | 148.6 | x | 107.7 | x         | 1.8  | 5.85  | x | 4.24  | x | 0.07  |

| REPLACES<br>OEM PT.NO. | FMC<br>PART NO. | MATERIAL  | GROOVE<br>DETAILS | TEETH/<br>TANGS | SIZE MM   |       |   | SIZE INCH |   |      |       |   |       |   |       |
|------------------------|-----------------|-----------|-------------------|-----------------|-----------|-------|---|-----------|---|------|-------|---|-------|---|-------|
| <b>STEYR</b>           |                 |           |                   |                 |           |       |   |           |   |      |       |   |       |   |       |
| 3777700440801          | FM2781          | GRAPHITE  | SUNBURST          | 15              | INT TH    | 213.0 | x | 44.0      | x | 10.0 | 8.38  | x | 1.73  | x | 0.394 |
| 1-31-722-105           | FM8329          | BRONZE    | SUNBURST          | 30              | EXT TH    | 118.3 |   | 77.3      | x | 2.2  | 4.66  | x | 3.04  | x | 0.087 |
| 1-31-722-310           | FM7689          | PAPER     | WAFFLE            | 10              | EXT LG    | 211.0 | x | 149.4     | x | 2.5  | 8.31  | x | 5.88  | x | 0.098 |
| 1-31-722-372           | FM7692MP        | STEEL     | SINEWAVED         | 47              | (48)IN TH | 198.0 | x | 131.6     | x | 2.8  | 7.8   | x | 5.18  | x | 0.11  |
| 1-31-722-378           | FM8332MP        | STEEL     | -----             | 36              | INT TH    | 110.9 | x | 70.7      | x | 1.5  | 4.37  | x | 2.78  | x | 0.059 |
| 33-744-605             | FM9485          | GRAPHITE  | SUNBURST          | 12              | INT TH    | 170.0 | x | 32.7      | x | 4.8  | 6.69  | x | 1.29  | x | 0.189 |
| 33-744-614             | FM3095          | GRAPHITE  | SUNBURST          | 13              | INT TH    | 215.0 | x | 36.5      | x | 10.0 | 8.46  | x | 1.44  | x | 0.394 |
| <b>STILL</b>           |                 |           |                   |                 |           |       |   |           |   |      |       |   |       |   |       |
| 149930                 | FM4815          | GRAPHITE  | SUNBURST          | 36              | (73)EX TH | 151.5 | x | 101.5     | x | 3.5  | 5.96  | x | 4.0   | x | 0.138 |
| 149932                 | FM4817          | GRAPH/STL | SUN/PLAIN         | 36              | (73)EX TH | 151.5 | x | 101.5     | x | 2.8  | 5.96  | x | 4.0   | x | 0.108 |
| 149943                 | FM2969          | BRONZE    | WAFFLE            | 22              | INT TH    | 71.7  | x | 44.0      | x | 1.6  | 2.82  | x | 1.73  | x | 0.063 |
| 9846631                | FM5911          | GRAPHITE  | SUN/RAD           | 16              | INT TH    | 204.0 | x | 40.0      | x | 4.9  | 8.03  | x | 1.57  | x | 0.193 |
| <b>STROMAG</b>         |                 |           |                   |                 |           |       |   |           |   |      |       |   |       |   |       |
| 298-850264-000         | FM2649          | BRONZE    | SPR/RAD           | 63              | (77)EX TH | 156.0 | x | 112.0     | x | 1.9  | 6.14  | x | 4.41  | x | 0.073 |
| <b>SUMITOMO EATON</b>  |                 |           |                   |                 |           |       |   |           |   |      |       |   |       |   |       |
| EE0539B                | FM6043          | PAPER     | WAFFLE            | 48              | INT TH    | 140.0 | x | 96.0      | x | 2.9  | 5.51  | x | 3.78  | x | 0.114 |
| LKM0060                | FM3930MP        | STEEL     | -----             | 4               | EXT LG    | 190.0 | x | 159.0     | x | 4.0  | 7.48  | x | 6.26  | x | 0.157 |
| LZM0228                | FM3927          | ELASTOMER | RADIAL            | 30              | (38)IN TH | 178.0 | x | 148.0     | x | 3.6  | 7.01  | x | 5.83  | x | 0.142 |
| LZM0310                | FM3930MP        | STEEL     | -----             | 4               | EXT LG    | 190.0 | x | 159.0     | x | 4.0  | 7.48  | x | 6.26  | x | 0.157 |
| <b>SVETRUCK</b>        |                 |           |                   |                 |           |       |   |           |   |      |       |   |       |   |       |
| 904017                 | FM3747          | BRONZE    | SPR/RAD           | 104             | INT TH    | 437.9 | x | 325.1     | x | 4.3  | 17.24 | x | 12.8  | x | 0.169 |
| 904018                 | FM3750MP        | STEEL     | -----             | 142             | EXT TH    | 455.0 | x | 342.0     | x | 3.2  | 17.91 | x | 13.46 | x | 0.126 |
| 907753                 | FM4349          | PAPER     | WAFFLE            | 42              | INT TH    | 340.0 | x | 206.0     | x | 5.5  | 13.39 | x | 8.11  | x | 0.217 |
| 907995                 | FM3747          | BRONZE    | SPR/RAD           | 104             | INT TH    | 437.9 | x | 325.1     | x | 4.3  | 17.24 | x | 12.8  | x | 0.169 |



| REPLACES<br>OEM PT.NO. | FMC<br>PART NO. | MATERIAL  | GROOVE<br>DETAILS | TEETH/<br>TANGS | SIZE MM   |       |   | SIZE INCH |   |     |       |   |       |   |       |
|------------------------|-----------------|-----------|-------------------|-----------------|-----------|-------|---|-----------|---|-----|-------|---|-------|---|-------|
| <b>TADANO</b>          |                 |           |                   |                 |           |       |   |           |   |     |       |   |       |   |       |
| 32306-99802            | FM3239          | PAPER     | WAFFLE            | 34              | INT TH    | 167.6 | x | 105.0     | x | 2.0 | 6.6   | x | 4.13  | x | 0.08  |
| 32307-99800            | FM4256MP        | STEEL     | -----             | 85              | EXT TH    | 181.5 | x | 116.0     | x | 1.8 | 7.15  | x | 4.57  | x | 0.071 |
| 223-21008100           | FM3360MP        | STEEL     | -----             | 64              | EXT TH    | 164.3 | x | 107.0     | x | 2.0 | 6.47  | x | 4.21  | x | 0.079 |
| 346-72025670           | FM5813          | PAPER     | 2 PASS            | 43              | INT TH    | 173.8 | x | 103.0     | x | 2.5 | 6.84  | x | 4.06  | x | 0.098 |
| 347-62026010           | FM2934MP        | STEEL     | BLACK             | 12              | EXT LG    | 183.4 | x | 118.0     | x | 1.6 | 7.22  | x | 4.65  | x | 0.063 |
| 360-70441000           | FM5149          | PAPER     | WAFFLE            |                 | RING      | 122.5 | x | 71.0      | x | 3.0 | 4.82  | x | 2.8   | x | 0.118 |
| 360-70445010           | FM5149          | PAPER     | WAFFLE            |                 | RING      | 122.5 | x | 71.0      | x | 3.0 | 4.82  | x | 2.8   | x | 0.118 |
| 363-50035770           | FM4180MP        | STEEL     | -----             | 42              | INT TH    | 132.8 | x | 85.5      | x | 1.5 | 5.23  | x | 3.37  | x | 0.059 |
| 363-50035780           | FM4181          | BRONZE    | SUNBURST          | 66              | EXT TH    | 143.1 | x | 93.0      | x | 2.8 | 5.63  | x | 3.66  | x | 0.11  |
| 363-50035910           | FM4181          | BRONZE    | SUNBURST          | 66              | EXT TH    | 143.1 | x | 93.0      | x | 2.8 | 5.63  | x | 3.66  | x | 0.11  |
| 363-50205690           | FM2653B         | BRONZE    | SUNBURST          | 76              | EXT TH    | 164.0 | x | 110.0     | x | 2.2 | 6.46  | x | 4.33  | x | 0.087 |
| 363-50205700           | FM4178MP        | STEEL     | DISHED            | 48              | INT TH    | 151.0 | x | 98.2      | x | 1.5 | 5.94  | x | 3.87  | x | 0.059 |
| 363-50245530           | FM8746MP        | STEEL     | -----             | 48              | INT TH    | 151.0 | x | 98.2      | x | 1.5 | 5.94  | x | 3.87  | x | 0.059 |
| 363-50366000           | FM4391          | PAPER     | 2 PASS            | 41              | INT TH    | 125.0 | x | 68.6      | x | 2.1 | 4.92  | x | 2.7   | x | 0.081 |
| 363-50445230           | FM2642MP        | STEEL     | -----             | 42              | EXT TH    | 131.4 | x | 80.0      | x | 1.6 | 5.17  | x | 3.15  | x | 0.063 |
| 363-70045270           | FM2633          | BRONZE    | SUNBURST          | 66              | EXT TH    | 142.6 | x | 85.7      | x | 2.8 | 5.61  | x | 3.37  | x | 0.11  |
| 363-70045280           | FM2636MP        | STEEL     | -----             | 38              | INT TH    | 133.0 | x | 77.0      | x | 1.5 | 5.24  | x | 3.03  | x | 0.059 |
| 363-70055120           | FM5466MP        | STEEL     | -----             | 89              | EXT TH    | 285.8 | x | 225.0     | x | 2.3 | 11.25 | x | 8.86  | x | 0.091 |
| 363-70375290           | FM5173          | PAPER/STL | WAFFLE            | 66              | EXT TH    | 143.1 | x | 93.5      | x | 1.8 | 5.63  | x | 3.68  | x | 0.071 |
| 363-70375300           | FM4180MP        | STEEL     | -----             | 42              | INT TH    | 132.8 | x | 85.5      | x | 1.5 | 5.23  | x | 3.37  | x | 0.059 |
| 363-70375310           | FM5171          | PAPER     | WAFFLE            | 66              | EXT TH    | 143.1 | x | 93.5      | x | 2.4 | 5.63  | x | 3.68  | x | 0.094 |
| <b>TAILIFT</b>         |                 |           |                   |                 |           |       |   |           |   |     |       |   |       |   |       |
| 32560514               | FM7186MP        | STEEL     | -----             | 6               | EXT LG    | 140.0 | x | 77.0      | x | 1.5 | 0.55  | x | 3.03  | x | 0.059 |
| 92560513               | FM2061          | PAPER     | WAFFLE            | 41              | INT TH    | 125.0 | x | 68.6      | x | 2.6 | 4.92  | x | 2.7   | x | 0.102 |
| <b>TAMROCK</b>         |                 |           |                   |                 |           |       |   |           |   |     |       |   |       |   |       |
| 4690267                | FM1204MP        | STEEL     | -----             | 1               | EXT LG    | 228.6 | x | 127.0     | x | 2.7 | 9     | x | 5.0   | x | 0.106 |
| 4690268                | FM1707          | BRONZE    | SPR/WAG           | 27              | INT TH    | 224.0 | x | 55.1      | x | 4.8 | 8.82  | x | 2.17  | x | 0.19  |
| 4697094                | FM2725          | GRAPHITE  | SUNBURST          | 60              | INT TH    | 292.1 | x | 207.0     | x | 4.0 | 11.5  | x | 8.15  | x | 0.156 |
| 4697216                | FM1216MP        | STEEL     | -----             | 60              | EXT TH    | 154.2 | x | 113.8     | x | 1.8 | 6.07  | x | 4.48  | x | 0.07  |
| 4697678                | FM2686MP        | STEEL     | -----             | 48              | (96)EX TH | 499.1 | x | 337.8     | x | 4.8 | 19.65 | x | 13.3  | x | 0.187 |
| 4697679                | FM2683          | GRAPHITE  | SUNBURST          | 34              | (38)IN TH | 457.2 | x | 313.4     | x | 6.8 | 18.0  | x | 12.34 | x | 0.268 |
| 4697727                | FM1723?         | GRAPHITE  | SUNBURST          | 36              | INT TH    | 394.5 | x | 222.3     | x | 6.2 | 15.53 | x | 8.75  | x | 0.245 |
| 4698030                | FM1782MP        | STEEL     | -----             | 9               | EXT LG    | 477.8 | x | 338.6     | x | 4.7 | 18.81 | x | 13.33 | x | 0.185 |
| 4698031                | FM1779          | GRAPHITE  | SUNBURST          | 34              | (38)IN TH | 456.7 | x | 313.7     | x | 7.8 | 17.98 | x | 12.35 | x | 0.308 |
| 4698068                | FM1278MP        | STEEL     | -----             | 14              | (20)EX TH | 218.9 | x | 158.8     | x | 2.7 | 8.62  | x | 6.25  | x | 0.106 |
| 4698069                | FM1191          | GRAPHITE  | SUNBURST          | 60              | INT TH    | 195.1 | x | 145.0     | x | 4.0 | 7.68  | x | 5.71  | x | 0.156 |
| 4698491                | FM2738MP        | STEEL     | -----             | 71              | EXT TH    | 182.6 | x | 117.9     | x | 1.8 | 7.19  | x | 4.64  | x | 0.069 |
| 4698492                | FM2787          | GRAPHITE  | SUNBURST          | 52              | INT TH    | 175.3 | x | 106.7     | x | 2.9 | 6.9   | x | 4.2   | x | 0.114 |
| 4699659                | FM1375OE        | BRONZE    | RADIAL            | 45              | INT TH    | 133.1 | x | 92.7      | x | 2.4 | 5.24  | x | 3.65  | x | 0.093 |
| 4699660                | FM1324MP        | STEEL     | -----             | 54              | EXT TH    | 139.2 | x | 98.6      | x | 1.8 | 5.48  | x | 3.88  | x | 0.07  |
| 4699665                | FM1337OE        | BRONZE    | RADIAL            | 45              | INT TH    | 133.1 | x | 92.7      | x | 2.3 | 5.24  | x | 3.65  | x | 0.09  |
| 4699801                | FM1726MP        | STEEL     | -----             | 12              | EXT LG    | 414.3 | x | 254.0     | x | 4.7 | 16.31 | x | 10.0  | x | 0.185 |
| 4699943                | FM3679          | GRAPHITE  | SUNBURST          | 36              | INT TH    | 394.5 | x | 222.3     | x | 5.2 | 15.53 | x | 8.75  | x | 0.203 |
| 4699959                | FM1381OE        | BRONZE    | RADIAL            | 52              | INT TH    | 148.6 | x | 107.7     | x | 2.9 | 5.85  | x | 4.24  | x | 0.114 |

| REPLACES<br>OEM PT.NO.          | FMC<br>PART NO. | MATERIAL | GROOVE<br>DETAILS | TEETH/<br>TANGS | SIZE MM              | SIZE INCH             |
|---------------------------------|-----------------|----------|-------------------|-----------------|----------------------|-----------------------|
| 4700418                         | FM1278MP        | STEEL    | -----             | 14 (20)EX TH    | 218.9 x 158.8 x 2.7  | 8.62 x 6.25 x 0.106   |
| 4700419                         | FM1195          | BRONZE   | SUNBURST          | 60 INT TH       | 195.1 x 145.0 x 4.0  | 7.68 x 5.71 x 0.156   |
| 4700426                         | FM1193          | GRAPHITE | SUNBURST          | 72 INT TH       | 233.4 x 175.5 x 4.0  | 9.19 x 6.91 x 0.156   |
| 4700428                         | FM1218MP        | STEEL    | -----             | 16 (24)EX TH    | 257.3 x 190.5 x 2.7  | 10.13 x 7.5 x 0.106   |
| 4700647                         | FM1305OE        | BRONZE   | RADIAL            | 52 INT TH       | 148.6 x 107.7 x 2.6  | 5.85 x 4.24 x 0.102   |
| 4700648                         | FM1216MP        | STEEL    | -----             | 60 EXT TH       | 154.2 x 113.8 x 1.8  | 6.07 x 4.48 x 0.07    |
| 4700651                         | FM1307OE        | BRONZE   | RADIAL            | 52 INT TH       | 148.6 x 107.7 x 2.6  | 5.85 x 4.24 x 0.102   |
| <b>TCI</b>                      |                 |          |                   |                 |                      |                       |
| 93636                           | FM5452MP        | STEEL    | END PLATE         | 54 EXT TH       | 139.2 x 98.2 x 8.7   | 5.48 x 3.87 x 0.343   |
| 93637                           | FM2465          | PAPER    | 1 PASS            | 43 (45)IN TH    | 133.1 x 92.7 x 1.6   | 5.24 x 3.65 x 0.063   |
| 93638                           | FM1324MP        | STEEL    | -----             | 54 EXT TH       | 139.2 x 98.6 x 1.8   | 5.48 x 3.88 x 0.07    |
| 93639                           | FM5442MP        | STEEL    | END PLATE         | 54 EXT TH       | 139.2 x 98.2 x 8.3   | 5.48 x 3.87 x 0.327   |
| 93645                           | FM1938MP        | STEEL    | -----             | 3 EXT LG        | 214.9 x 155.7 x 1.8  | 8.46 x 6.13 x 0.07    |
| <b>TCM FORKLIFT, SEE MITSUI</b> |                 |          |                   |                 |                      |                       |
| <b>TCM</b>                      |                 |          |                   |                 |                      |                       |
| 16262-52601                     | FM5806MP        | STEEL    | -----             | 56 (60)EX TH    | 154.2 x 113.8 x 1.8  | 6.07 x 4.48 x 0.071   |
| 16262-53091                     | FM2029          | PAPER    | 2 PASS            | 52 INT TH       | 148.6 x 107.7 x 2.9  | 5.85 x 4.24 x 0.114   |
| 163G3-02131                     | FM9329          | PAPER    | WAFFLE            | 33 INT TH       | 361.6 x 122.5 x 6.2  | 14.24 x 4.82 x 0.244  |
| 163H3-02111                     | FM9327          | PAPER    | WAFFLE            | 33 INT TH       | 387.5 x 122.5 x 6.2  | 15.26 x 4.82 x 0.244  |
| 163J3-02111                     | FM4375          | PAPER    | WAFFLE            | 33 INT TH       | 400.0 x 122.5 x 6.2  | 15.75 x 4.82 x 0.244  |
| 163J3-02131                     | FM4378MP        | STEEL    | -----             | 8 EXT LG        | 418.6 x 312.0 x 5.0  | 16.48 x 12.28 x 0.197 |
| 163J3-02321                     | FM4380MP        | STEEL    | -----             | 8 EXT LG        | 418.6 x 312.0 x 10.0 | 16.48 x 12.28 x 0.394 |
| 163J2-52501                     | FM4831          | PAPER    | 2 PASS            | 26 INT TH       | 160.0 x 97.5 x 2.2   | 6.3 x 3.84 x 0.087    |
| 163J2-52591                     | FM2914MP        | STEEL    | -----             | 68 EXT TH       | 174.1 x 110.0 x 1.7  | 6.85 x 4.33 x 0.066   |
| 16382-54221                     | FM4220MP        | STEEL    | -----             | 35 EXT TH       | 138.6 x 90.5 x 1.6   | 5.46 x 3.56 x 0.063   |
| 16382-54232                     | FM4615          | PAPER    | 2 PASS            | 34 INT TH       | 130.0 x 85.0 x 2.5   | 5.12 x 3.35 x 0.098   |
| 16382-54721                     | FM4215          | BRONZE   | SUNBURST          | 34 INT TH       | 130.0 x 85.0 x 2.5   | 5.12 x 3.35 x 0.098   |
| 16383-02171                     | FM4881          | PAPER    | WAFFLE            | 23 INT TH       | 280.0 x 87.5 x 6.2   | 11.02 x 3.44 x 0.244  |
| 16422-52271                     | FM4206MP        | STEEL    | -----             | 68 EXT TH       | 173.9 x 113.0 x 1.7  | 6.85 x 4.45 x 0.067   |
| 16422-52281                     | FM4265          | PAPER    | WAFFLE            | 52 INT TH       | 160.0 x 107.5 x 2.2  | 6.3 x 4.23 x 0.087    |
| 16422-52801                     | FM4615          | PAPER    | 2 PASS            | 34 INT TH       | 130.0 x 85.0 x 2.5   | 5.12 x 3.35 x 0.098   |
| 16503-02332                     | FM2399          | PAPER    | WAFFLE            | 35 INT TH       | 370.1 x 126.2 x 7.2  | 14.57 x 4.97 x 0.283  |
| 16602-52691                     | FM5803          | BRONZE   | SUNBURST          | 52 INT TH       | 148.6 x 107.5 x 3.0  | 5.85 x 4.23 x 0.118   |
| 16603-02911                     | FM2339          | PAPER    | 3 PASS            | 35 INT TH       | 362.0 x 126.2 x 7.2  | 14.25 x 4.97 x 0.283  |
| 16703-02303                     | FM5772MP        | OBSOLETE | -----             | 9 EXT LG        | 404.0 x 278.0 x 11.5 | 15.91 x 10.94 x 0.453 |
| 16703-02481                     | FM2187          | PAPER    | WAFFLE            | 35 INT TH       | 390.4 x 126.2 x 7.2  | 15.37 x 4.97 x 0.283  |
| 16763-02101                     | FM4317          | PAPER    | WAFFLE            | 33 INT TH       | 344.0 x 122.5 x 6.2  | 13.54 x 4.82 x 0.244  |
| 16772-52461                     | FM4203          | PAPER    | 2 PASS            | 52 INT TH       | 160.0 x 107.5 x 2.2  | 6.3 x 4.23 x 0.087    |
| 16783-02331                     | FM4375          | PAPER    | WAFFLE            | 33 INT TH       | 400.0 x 122.5 x 6.2  | 15.75 x 4.82 x 0.244  |
| 18223-02452                     | FM5187          | PAPER    | 2 PASS            | 23 INT TH       | 308.0 x 87.5 x 6.2   | 12.13 x 3.44 x 0.244  |

| REPLACES<br>OEM PT.NO. | FMC<br>PART NO. | MATERIAL | GROOVE<br>DETAILS | TEETH/<br>TANGS | SIZE MM | SIZE INCH |
|------------------------|-----------------|----------|-------------------|-----------------|---------|-----------|
|------------------------|-----------------|----------|-------------------|-----------------|---------|-----------|

**TEREX (ALSO SEE ALLISON)**

|          |          |            |              |     |             |                     |                       |
|----------|----------|------------|--------------|-----|-------------|---------------------|-----------------------|
| 9157053  | FM2825   | BRONZE     | SUNBURST     | 45  | INT TH      | 133.0 x 93.0 x 1.8  | 5.24 x 3.66 x 0.069   |
| 9157072  | FM3667   | PAPER      | 2 PASS       | 44  | INT TH      | 196.9 x 138.0 x 2.8 | 7.75 x 5.43 x 0.11    |
| 9398051  | FM3969   | PAPER      | RADIAL       | 18  | INT TH      | 329.0 x 285.0 x 3.0 | 12.96 x 11.24 x 0.117 |
| 9398081  | FM2277   | BRONZE     | SUNBURST     | 27  | EXT TH      | 137.4 x 90.9 x 2.0  | 5.41 x 3.58 x 0.079   |
| 9398104  | FM3594MP | STEEL      | -----        | 29  | INT TH      | 131.1 x 85.1 x 2.0  | 5.16 x 3.35 x 0.079   |
| 9398105  | FM3596MP | STEEL      | -----        | 29  | INT TH      | 131.1 x 85.1 x 2.5  | 5.16 x 3.35 x 0.098   |
| 9398107  | FM3592MP | STEEL      | -----        | 29  | INT TH      | 131.1 x 85.1 x 1.5  | 5.16 x 3.35 x 0.059   |
| 9398112  | FM2279   | BRONZE     | SUNBURST     | 35  | EXT TH      | 177.5 x 109.0 x 2.0 | 6.99 x 4.29 x 0.079   |
| 9398144  | FM3604MP | STEEL      | -----        | 35  | INT TH      | 170.9 x 102.9 x 2.5 | 6.73 x 4.05 x 0.098   |
| 9398148  | FM3600MP | STEEL      | -----        | 35  | INT TH      | 170.9 x 102.9 x 1.5 | 6.73 x 4.05 x 0.059   |
| 9398591  | FM4449   | MOLYBDENUM | SPR/WAG      | 26  | INT TH      | 147.8 x 75.4 x 3.0  | 5.82 x 2.97 x 0.118   |
| 9399455  | FM2943   | BRONZE     | SPR/RAD      | 42  | EXT TH      | 212.5 x 154.5 x 2.5 | 8.37 x 6.08 x 0.098   |
| 9399470  | FM5367   | BRONZE     | SPR/RAD      | 75  | INT TH      | 373.2 x 295.5 x 3.3 | 14.69 x 11.63 x 0.128 |
| 9399534  | FM2962MP | STEEL      | -----        | 37  | INT TH      | 204.6 x 143.8 x 2.0 | 8.06 x 5.66 x 0.079   |
| 9399545  | FM5370MP | STEEL      | -----        | 14  | EXT SL      | 399.5 x 310.3 x 3.0 | 15.73 x 12.22 x 0.118 |
| 9433804  | FM7901   | GRAPHITE   | SUNBURST     | 45  | (54)INT TH  | 298.0 x 106.0 x 3.9 | 11.73 x 4.17 x 0.152  |
| 9433805  | FM6998MP | STEEL      | -----        | 6   | EXT LG      | 334.0 x 225.0 x 3.0 | 13.15 x 8.86 x 0.118  |
| 15000717 | FM1901   | PAPER      | 3 PASS       | 99  | (102)INT TH | 715.3 x 511.3 x 5.1 | 28.16 x 20.13 x 0.2   |
| 15000719 | FM1906MP | STEEL      | -----        | 140 | (144)EXT TH | 737.9 x 539.8 x 2.5 | 29.05 x 21.25 x 0.1   |
| 15000720 | FM1903   | CORK       | -----        | 140 | (144)EXT TH | 737.9 x 539.8 x 6.9 | 29.05 x 21.25 x 0.27  |
| 15235882 | FM1901   | PAPER      | 3 PASS       | 99  | (102)INT TH | 715.3 x 511.3 x 5.1 | 28.16 x 20.13 x 0.2   |
| 15248874 | FM5641   | PAPER      | 3 PASS       | 92  | INT TH      | 650.0 x 460.0 x 5.1 | 25.59 x 18.11 x 0.201 |
| 15248888 | FM5644MP | STEEL      | -----        | 132 | EXT TH      | 677.7 x 492.6 x 2.4 | 26.68 x 19.39 x 0.094 |
| 15248889 | FM5645   | CORK       | -----        | 132 | EXT TH      | 677.7 x 492.6 x 6.9 | 26.68 x 19.39 x 0.272 |
| 15265538 | FM3801   | PAPER      | RADIAL       | 30  | INT LG      | 329.0 x 285.0 x 3.0 | 12.96 x 11.24 x 0.117 |
| 15267525 | FM4125   | BRONZE     | SUN-PLAIN    | 35  | EXT TH      | 177.5 x 109.0 x 1.6 | 6.99 x 4.29 x 0.063   |
| 15267531 | FM3801   | PAPER      | RADIAL       | 30  | INT LG      | 329.0 x 285.0 x 3.0 | 12.96 x 11.24 x 0.117 |
| 15267537 | FM4123   | BRONZE     | SUN-PLAIN    | 27  | EXT TH      | 137.4 x 90.9 x 1.6  | 5.41 x 3.58 x 0.063   |
| 15269366 | FM4282MP | STEEL      | -----        | 45  | INT TH      | 185.0 x 132.7 x 2.5 | 7.28 x 5.22 x 0.098   |
| 15269367 | FM4284MP | STEEL      | -----        | 45  | INT TH      | 185.0 x 132.7 x 3.0 | 7.28 x 5.22 x 0.118   |
| 15269368 | FM4286MP | STEEL      | -----        | 45  | INT TH      | 185.0 x 132.7 x 3.5 | 7.28 x 5.22 x 0.138   |
| 15269369 | FM4288MP | STEEL      | -----        | 45  | INT TH      | 185.0 x 132.7 x 4.0 | 7.28 x 5.22 x 0.157   |
| 15269370 | FM4397   | BRONZE     | SUNBURST     | 64  | EXT TH      | 196.0 x 142.0 x 2.5 | 7.72 x 5.59 x 0.096   |
| 15269371 | FM4399   | BRNZ/PLN   | SUNBURST     | 64  | EXT TH      | 196.0 x 142.0 x 2.0 | 7.72 x 5.59 x 0.077   |
| 15269372 | FM4298MP | STEEL      | -----        | 45  | INT TH      | 170.0 x 132.7 x 2.5 | 6.69 x 5.22 x 0.098   |
| 15269373 | FM4296MP | STEEL      | -----        | 45  | INT TH      | 170.0 x 132.7 x 2.0 | 6.69 x 5.22 x 0.077   |
| 15269375 | FM4300MP | STEEL      | -----        | 45  | INT TH      | 170.0 x 132.7 x 3.0 | 6.69 x 5.22 x 0.118   |
| 15269376 | FM4302MP | STEEL      | -----        | 45  | INT TH      | 170.0 x 132.7 x 3.5 | 6.69 x 5.22 x 0.138   |
| 15269377 | FM4289   | BRONZE     | SPR/RAD      | 35  | EXT TH      | 176.5 x 142.0 x 2.5 | 6.95 x 5.51 x 0.096   |
| 15269378 | FM4291   | BRNZ/PLN   | SPR/RAD      | 35  | EXT TH      | 176.5 x 142.0 x 2.0 | 6.95 x 5.51 x 0.077   |
| 15271592 | FM4288MP | STEEL      | -----        | 45  | INT TH      | 185.0 x 132.7 x 4.0 | 7.28 x 5.22 x 0.157   |
| 15271593 | FM4282MP | STEEL      | -----        | 45  | INT TH      | 185.0 x 132.7 x 2.5 | 7.28 x 5.22 x 0.098   |
| 15271594 | FM4284MP | STEEL      | -----        | 45  | INT TH      | 185.0 x 132.7 x 3.0 | 7.28 x 5.22 x 0.118   |
| 15271595 | FM4286MP | STEEL      | -----        | 45  | INT TH      | 185.0 x 132.7 x 3.5 | 7.28 x 5.22 x 0.138   |
| 15271597 | FM4280MP | STEEL      | -----        | 45  | INT TH      | 185.0 x 132.7 x 2.0 | 7.28 x 5.22 x 0.077   |
| 15271598 | FM6781   | CARBON PA  | RADIAL       | 64  | EXT TH      | 196.0 x 142.0 x 2.6 | 7.72 x 5.59 x 0.1     |
| 15271599 | FM6783   | CARBON PA  | RADIAL/PLAIN | 64  | EXT TH      | 196.0 x 142.0 x 2.0 | 7.72 x 5.59 x 0.079   |



# Terex Transmission Discs

---

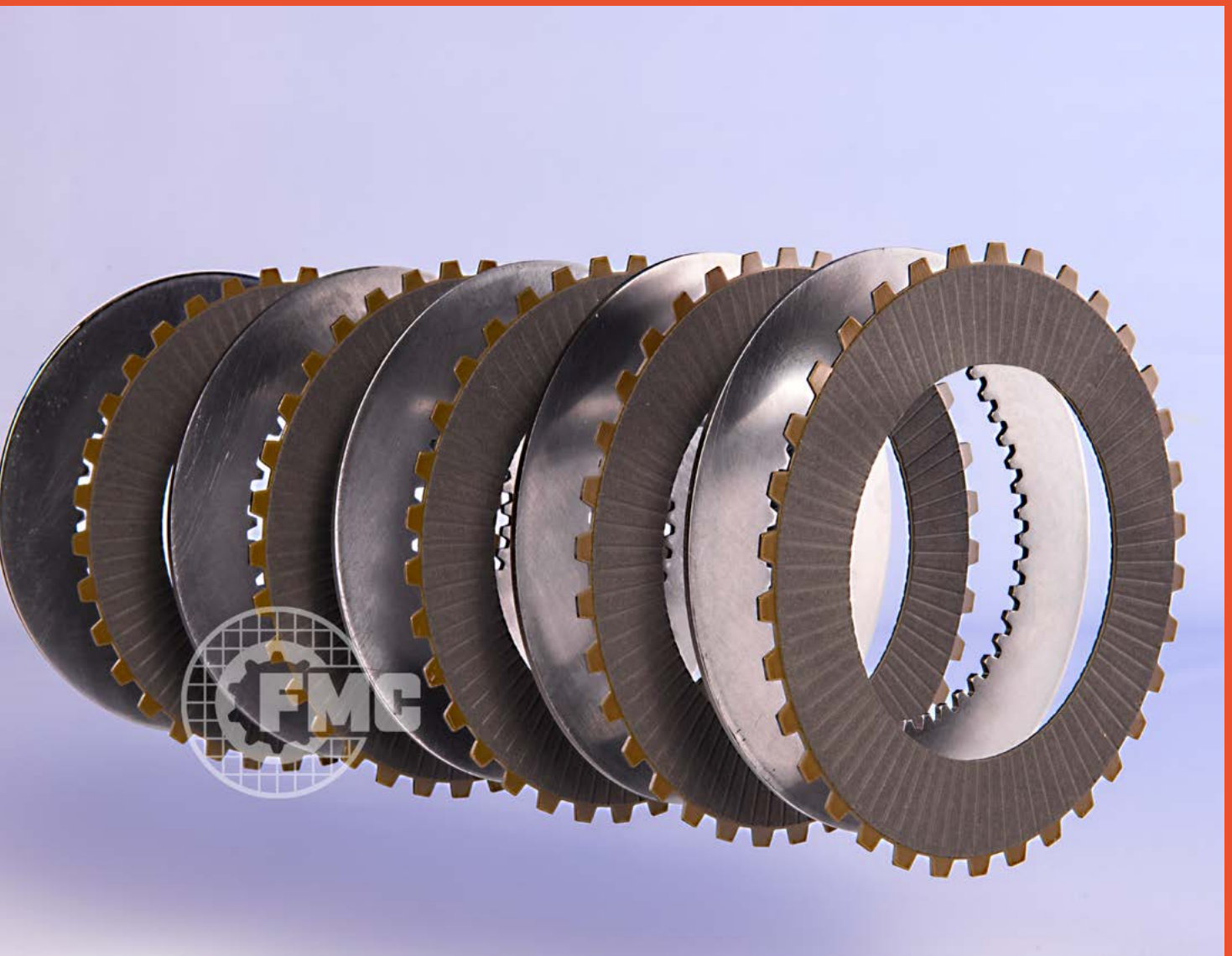

| REPLACES<br>OEM PT.NO. | FMC<br>PART NO. | MATERIAL    | GROOVE<br>DETAILS | TEETH/<br>TANGS | SIZE MM    | SIZE INCH                                 |
|------------------------|-----------------|-------------|-------------------|-----------------|------------|---|
| 15271600               | FM4298MP        | STEEL       | -----             | 45              | INT TH     | 170.0 x 132.7 x 2.5 6.69 x 5.22 x 0.098   |
| 15271601               | FM4300MP        | STEEL       | -----             | 45              | INT TH     | 170.0 x 132.7 x 3.0 6.69 x 5.22 x 0.118   |
| 15271602               | FM4298MP        | STEEL       | -----             | 45              | INT TH     | 170.0 x 132.7 x 2.5 6.69 x 5.22 x 0.098   |
| 15271603               | FM4296MP        | STEEL       | -----             | 45              | INT TH     | 170.0 x 132.7 x 2.0 6.69 x 5.22 x 0.077   |
| 15271604               | FM8595          | CARBON PA   | RADIAL            | 35              | EXT TH     | 176.5 x 142.0 x 2.5 6.95 x 5.51 x 0.096   |
| 15271605               | FM8597          | CARBON PA   | RADIAL/PLAIN      | 35              | EXT TH     | 176.5 x 142.0 x 1.9 6.95 x 5.51 x 0.073   |
| 15272500               | FM4785          | PAPER/PLAIN | RADIAL            | 34              | EXT TH     | 177.4 x 111.5 x 1.9 6.98 x 4.39 x 0.075   |
| 15272501               | FM4783          | CARBON PA   | RADIAL            | 34              | EXT TH     | 177.4 x 111.5 x 2.5 6.98 x 4.39 x 0.098   |
| 15272502               | FM4786MP        | STEEL       | -----             | 42              | INT TH     | 167.8 x 102.5 x 2.5 6.61 x 4.04 x 0.098   |
| 15272537               | FM4789          | PAPER/PLAIN | RADIAL            | 44              | EXT TH     | 158.8 x 111.5 x 1.9 6.25 x 4.39 x 0.075   |
| 15272538               | FM4787          | CARBON PA   | RADIAL            | 44              | EXT TH     | 158.8 x 111.5 x 2.5 6.25 x 4.39 x 0.098   |
| 15272539               | FM4790MP        | STEEL       | -----             | 42              | INT TH     | 150.9 x 102.5 x 2.5 5.94 x 4.04 x 0.098   |
| 15273279               | FM5250-2.9      | STEEL       | HARDENED          | 4               | EXT LG     | 189.8 x 92.1 x 2.9 7.47 x 3.63 x 0.114    |
| 15273282               | FM5250-3.3      | STEEL       | HARDENED          | 4               | EXT LG     | 189.8 x 92.1 x 3.3 7.47 x 3.63 x 0.13     |
| 15273283               | FM5247          | MOLYBDENUM  | SPR/WAG           | 40              | INT TH     | 172.0 x 84.1 x 3.0 6.77 x 3.31 x 0.118    |
| 15275520               | FM1779          | GRAPHITE    | SUNBURST          | 34              | (38)IN TH  | 456.7 x 313.7 x 7.8 17.98 x 12.35 x 0.308 |
| 15275521               | FM3292MP        | STEEL       | -----             | 30              | (55)EX TH  | 474.0 x 338.6 x 4.7 18.66 x 13.33 x 0.185 |
| 15275704               | FM8681          | PAPER       | WAFFLE            | 78              | INT TH     | 446.0 x 312.0 x 4.8 17.56 x 12.28 x 0.187 |
| 15275705               | FM8684MP        | STEEL       | -----             | 20              | EXT LG     | 473.0 x 322.0 x 4.0 18.62 x 12.68 x 0.157 |
| 15275783               | FM4785          | PAPER/PLAIN | RADIAL            | 34              | EXT TH     | 177.4 x 111.5 x 1.9 6.98 x 4.39 x 0.075   |
| 15275784               | FM4783          | CARBON PA   | RADIAL            | 34              | EXT TH     | 177.4 x 111.5 x 2.5 6.98 x 4.39 x 0.098   |
| 15302796               | FM1901          | PAPER       | 3 PASS            | 99              | (102)IN TH | 715.3 x 511.3 x 5.1 28.16 x 20.13 x 0.2   |
| 15302797               | FM1906MP        | STEEL       | -----             | 140             | (144)EX TH | 737.9 x 539.8 x 2.5 29.05 x 21.25 x 0.1   |
| 15302798               | FM1903          | CORK        | -----             | 140             | (144)EX TH | 737.9 x 539.8 x 6.9 29.05 x 21.25 x 0.27  |
| 15500052               | FM4304MP        | STEEL       | -----             | 45              | INT TH     | 170.0 x 132.7 x 4.0 6.69 x 5.22 x 0.157   |
| 15500384               | FM4647          | BRONZE      | SPR/RAD           | 34              | INT TH     | 100.0 x 68.2 x 1.6 3.94 x 2.69 x 0.061    |
| 15500385               | FM4650MP        | STEEL       | -----             | 24              | EXT TH     | 108.2 x 76.2 x 1.2 4.26 x 3.0 x 0.045     |
| 15501082               | FM4666-2.2      | STEEL       | HARDENED          | 6               | EXT SL     | 130.0 x 66.8 x 2.2 5.12 x 2.63 x 0.087    |
| 15501083               | FM4666MP        | STEEL       | HARDENED          | 6               | EXT SL     | 130.0 x 66.8 x 2.3 5.12 x 2.63 x 0.091    |
| 15501084               | FM4666-2.4      | STEEL       | HARDENED          | 6               | EXT SL     | 130.0 x 66.8 x 2.4 5.12 x 2.63 x 0.094    |
| 15501085               | FM4666-2.5      | STEEL       | HARDENED          | 6               | EXT SL     | 130.0 x 66.8 x 2.5 5.12 x 2.63 x 0.098    |
| 15501087               | FM4451          | MOLYBDENUM  | SPR/WAG           | 46              | (50)IN TH  | 117.5 x 62.6 x 2.6 4.63 x 2.46 x 0.102    |
| 15501612               | FM7271          | GRAPHITE    | SUNBURST          | 54              | INT TH     | 196.0 x 105.5 x 3.2 7.72 x 4.15 x 0.126   |
| 15501613               | FM9120MP        | STEEL       | -----             | 8               | EXT LG     | 210.4 x 152.3 x 2.0 8.28 x 6.0 x 0.079    |
| 15501754               | FM6998MP        | STEEL       | -----             | 6               | EXT LG     | 334.0 x 225.0 x 3.0 13.15 x 8.86 x 0.118  |
| 15502718               | FM6399          | PAPER       | WAFFLE            | 49              | (58)IN TH  | 297.5 x 116.2 x 5.0 11.71 x 4.57 x 0.197  |
| 15503273               | FM9145          | BRONZE      | WAF/WAG           | 78              | INT TH     | 445.5 x 312.3 x 4.0 17.54 x 12.3 x 0.157  |
| 15503274               | FM9264-2.6      | STEEL       | HARDEDED          | 20              | EXT LG     | 479.0 x 322.0 x 2.6 18.86 x 12.68 x 0.102 |
| 15503275               | FM9264-3.2      | STEEL       | HARDEDED          | 20              | EXT LG     | 479.0 x 322.0 x 3.2 18.86 x 12.68 x 0.126 |
| 15503276               | FM9264-3.0      | STEEL       | HARDEDED          | 20              | EXT LG     | 479.0 x 322.0 x 3.0 18.86 x 12.68 x 0.118 |
| 15503277               | FM9264-2.8      | STEEL       | HARDEDED          | 20              | EXT LG     | 479.0 x 322.0 x 2.8 18.86 x 12.68 x 0.11  |
| 15503278               | FM9264-4.0      | STEEL       | HARDEDED          | 20              | EXT LG     | 479.0 x 322.0 x 4.0 18.86 x 12.68 x 0.157 |
| 15503646               | FM8982MP        | STEEL       | -----             | 5               | EXT TH     | 333.5 x 225.5 x 3.5 13.13 x 8.88 x 0.136  |
| 15504023               | FM8979          | CARBON PA   | WAFFLE            | 49              | (58)IN TH  | 298.2 x 116.5 x 5.0 11.74 x 4.59 x 0.197  |
| 22833701               | FM4451          | MOLYBDENUM  | SPR/WAG           | 46              | (50)IN TH  | 117.5 x 62.6 x 2.6 4.63 x 2.46 x 0.102    |
| 22833706               | FM4666-2.2      | STEEL       | HARDENED          | 6               | EXT SL     | 130.0 x 66.8 x 2.2 5.12 x 2.63 x 0.087    |
| 7-126-479              | FM2719          | PAPER       | 2 PASS            | 33              | INT TH     | 117.9 x 68.1 x 2.2 4.65 x 2.68 x 0.087    |
| 7-229-649              | FM2719          | PAPER       | 2 PASS            | 33              | INT TH     | 117.9 x 68.1 x 2.2 4.65 x 2.68 x 0.087    |

| REPLACES OEM PT.NO.             | FMC PART NO. | MATERIAL             | GROOVE DETAILS | TEETH/TANGS | SIZE MM   | SIZE INCH                                 |
|---------------------------------|--------------|----------------------|----------------|-------------|-----------|---|
| V007483                         | FM5177       | BRONZE               | SPIRAL         | 27          | EXT TH    | 84.2 x 58.5 x 1.8 3.31 x 2.3 x 0.071      |
| V007484                         | FM5180MP     | STEEL                | -----          | 28          | INT TH    | 76.7 x 54.2 x 1.0 3.02 x 2.13 x 0.039     |
| V008887                         | FM7215       | BRONZE               | WAFFLE         | 54          | EXT TH    | 109.5 x 81.6 x 1.9 4.31 x 3.21 x 0.075    |
| V008888                         | FM7218MP     | STEEL                | -----          | 52          | INT TH    | 102.0 x 77.0 x 1.5 4.02 x 3.03 x 0.059    |
| <b>THWAITES</b>                 |              |                      |                |             |           |   |
| T2503                           | FM1649       | PAPER                | 2 PASS         | 45          | INT TH    | 133.1 x 92.7 x 1.6 5.24 x 3.65 x 0.063    |
| T3570                           | FM1340MP     | OBSOLETE AFTER STOCK |                | 1           | EXT LG    | 158.8 x 83.8 x 2.7 6.25 x 3.3 x 0.105     |
| T3571                           | FM1377       | BRONZE               | SPR/WAG        | 23          | INT TH    | 152.4 x 35.6 x 4.8 6.0 x 1.4 x 0.19       |
| T3947                           | FM1204MP     | STEEL                | -----          | 1           | EXT LG    | 228.6 x 127.0 x 2.7 9.0 x 5.0 x 0.106     |
| T3948                           | FM1707       | BRONZE               | SPR/WAG        | 27          | INT TH    | 224.0 x 55.1 x 4.8 8.82 x 2.17 x 0.19     |
| T53874                          | FM8962MP     | STEEL                | -----          | 3           | EXT LG    | 180.0 x 111.1 x 2.7 7.09 x 4.37 x 0.106   |
| <b>TIMBERJACK</b>               |              |                      |                |             |           |   |
| 406216                          | FM1195       | BRONZE               | SUNBURST       | 60          | INT TH    | 195.1 x 145.0 x 4.0 7.68 x 5.71 x 0.156   |
| 6775541                         | FM1965       | BRONZE               | SPR/WAG        | 60          | INT TH    | 253.5 x 187.7 x 3.9 9.98 x 7.39 x 0.153   |
| F047367                         | FM5210MP     | STEEL                | -----          | 2           | EXT LG    | 253.0 x 150.0 x 2.6 9.96 x 5.91 x 0.102   |
| F056912                         | FM4717       | GRAPHITE             | SUNBURST       | 24          | INT TH    | 169.0 x 45.1 x 4.8 6.65 x 1.78 x 0.189    |
| <b>TONANCO</b>                  |              |                      |                |             |           |   |
| 3045-2180                       | FM3733       | BRONZE               | SUNBURST       | 76          | EXT TH    | 164.0 x 103.0 x 2.9 6.46 x 4.06 x 0.114   |
| 3045-2190                       | FM1660MP     | STEEL                | -----          | 45          | INT TH    | 152.4 x 92.5 x 1.6 6.0 x 3.64 x 0.063     |
| 3147-2180                       | FM2601       | OBSOLETE             | SUNBURST       | 84          | EXT TH    | 214.7 x 158.4 x 2.9 8.45 x 6.24 x 0.114   |
| 3147-2190                       | FM2604MP     | OBSOLETE             | -----          | 60          | INT TH    | 200.8 x 145.3 x 2.0 7.91 x 5.72 x 0.079   |
| 3247-2180                       | FM2693       | OBSOLETE             | SUNBURST       | 92          | EXT TH    | 235.0 x 179.0 x 2.9 9.25 x 7.05 x 0.114   |
| 3247-2190                       | FM2696MP     | OBSOLETE             | -----          | 62          | INT TH    | 221.0 x 165.0 x 2.0 8.7 x 6.5 x 0.079     |
| <b>TORO / TAMROCK / SANDVIK</b> |              |                      |                |             |           |   |
| 4678031                         | FM1779       | GRAPHITE             | SUNBURST       | 34          | (38)IN TH | 456.7 x 313.7 x 7.8 17.98 x 12.35 x 0.308 |
| 4690267                         | FM1204MP     | STEEL                | -----          | 1           | EXT LG    | 228.6 x 127.0 x 2.7 9.0 x 5.0 x 0.106     |
| 4690268                         | FM1707       | BRONZE               | SPR/WAG        | 27          | INT TH    | 224.0 x 55.1 x 4.8 8.82 x 2.17 x 0.19     |
| 4697094                         | FM2725       | GRAPHITE             | SUNBURST       | 60          | INT TH    | 292.1 x 207.0 x 4.0 11.5 x 8.15 x 0.156   |
| 4697216                         | FM1216MP     | STEEL                | -----          | 60          | EXT TH    | 154.2 x 113.8 x 1.8 6.07 x 4.48 x 0.07    |
| 4697450                         | FM7982MP     | STEEL                | SUNBURST       | 16          | EXT TH    | 176.2 x 103.5 x 3.9 6.94 x 4.07 x 0.155   |
| 4697678                         | FM2686MP     | STEEL                | -----          | 48          | (96)EX TH | 499.1 x 337.8 x 4.8 19.65 x 13.3 x 0.187  |
| 4697679                         | FM2683       | GRAPHITE             | SUNBURST       | 34          | (38)IN TH | 457.2 x 313.4 x 6.8 18.0 x 12.34 x 0.268  |
| 4697727                         | FM1723?      | GRAPHITE             | SUNBURST       | 36          | INT TH    | 394.5 x 222.3 x 6.2 15.53 x 8.75 x 0.245  |
| 4698030                         | FM1782MP     | STEEL                | -----          | 9           | EXT LG    | 477.8 x 338.6 x 4.7 18.81 x 13.33 x 0.185 |
| 4698031                         | FM1779       | GRAPHITE             | SUNBURST       | 34          | (38)IN TH | 456.7 x 313.7 x 7.8 17.98 x 12.35 x 0.308 |
| 4698069                         | FM1191       | GRAPHITE             | SUNBURST       | 60          | INT TH    | 195.1 x 145.0 x 4.0 7.68 x 5.71 x 0.156   |
| 4698491                         | FM2738MP     | STEEL                | -----          | 71          | EXT TH    | 182.6 x 117.9 x 1.8 7.19 x 4.64 x 0.069   |
| 4698492                         | FM2787       | GRAPHITE             | SUNBURST       | 52          | INT TH    | 175.3 x 106.7 x 2.9 6.9 x 4.2 x 0.114     |
| 4699313                         | FM7980MP     | STEEL                | SUNBURST       | 32          | (36)IN TH | 156.8 x 89.0 x 6.4 6.17 x 3.5 x 0.25      |
| 4699659                         | FM1375OE     | BRONZE               | RADIAL         | 45          | INT TH    | 133.1 x 92.7 x 2.4 5.24 x 3.65 x 0.093    |
| 4699660                         | FM1324MP     | STEEL                | -----          | 54          | EXT TH    | 139.2 x 98.6 x 1.8 5.48 x 3.88 x 0.07     |
| 4699665                         | FM1337OE     | BRONZE               | RADIAL         | 45          | INT TH    | 133.1 x 92.7 x 2.3 5.24 x 3.65 x 0.09     |

| REPLACES<br>OEM PT.NO. | FMC<br>PART NO. | MATERIAL  | GROOVE<br>DETAILS | TEETH/<br>TANGS | SIZE MM   | SIZE INCH            |                       |
|------------------------|-----------------|-----------|-------------------|-----------------|-----------|----------------------|-----------------------|
| 4699801                | FM1726MP        | STEEL     | -----             | 12              | EXT LG    | 414.3 x 254.0 x 4.7  | 16.31 x 10.0 x 0.185  |
| 4699869                | FM5239          | CARBON PA | 2 PASS            | 80              | INT TH    | 326.9 x 247.9 x 5.5  | 12.87 x 9.76 x 0.216  |
| 4699875                | FM6480MP        | STEEL     | -----             | 106             | EXT TH    | 341.0 x 267.5 x 12.5 | 13.43 x 10.53 x 0.492 |
| 4699876                | FM6478MP        | STEEL     | -----             | 106             | EXT TH    | 341.0 x 267.5 x 4.8  | 13.43 x 10.53 x 0.189 |
| 4699943                | FM1723          | GRAPHITE  | SUNBURST          | 36              | INT TH    | 394.5 x 222.3 x 6.2  | 15.53 x 8.75 x 0.245  |
| 4699959                | FM1381OE        | BRONZE    | RADIAL            | 52              | INT TH    | 148.6 x 107.7 x 2.9  | 5.85 x 4.24 x 0.114   |
| 4700419                | FM1195          | BRONZE    | SUNBURST          | 60              | INT TH    | 195.1 x 145.0 x 4.0  | 7.68 x 5.71 x 0.156   |
| 4700426                | FM1193          | GRAPHITE  | SUNBURST          | 72              | INT TH    | 233.4 x 175.5 x 4.0  | 9.19 x 6.91 x 0.156   |
| 4700428                | FM1218MP        | STEEL     | -----             | 16              | (24)EX TH | 257.3 x 190.5 x 2.7  | 10.13 x 7.5 x 0.106   |
| 4700647                | FM1305OE        | BRONZE    | RADIAL            | 52              | INT TH    | 148.6 x 107.7 x 2.6  | 5.85 x 4.24 x 0.102   |
| 4700648                | FM1216MP        | STEEL     | -----             | 60              | EXT TH    | 154.2 x 113.8 x 1.8  | 6.07 x 4.48 x 0.07    |
| 4700651                | FM1307OE        | BRONZE    | RADIAL            | 52              | INT TH    | 148.6 x 107.7 x 2.6  | 5.85 x 4.24 x 0.102   |
| 55053759               | FM6130MP        | STEEL     | -----             | 3               | EXT LG    | 268.0 x 176.0 x 4.5  | 10.55 x 6.93 x 0.177  |
| 55054883               | FM6127          | PAPER     | WAFFLE            | 24              | INT TH    | 253.0 x 69.0 x 6.1   | 9.96 x 2.72 x 0.24    |
| 56001037               | FM5237          | CARBON PA | 2 PASS            | 60              | INT TH    | 292.0 x 207.0 x 4.0  | 11.5 x 8.15 x 0.156   |
| 56002410               | FM2686MP        | STEEL     | -----             | 48              | (96)EX TH | 499.1 x 337.8 x 4.8  | 19.65 x 13.3 x 0.187  |
| 56002411               | FM5159          | CARBON PA | 3 PASS            | 34              | (38)IN TH | 456.7 x 313.7 x 6.8  | 17.98 x 12.35 x 0.268 |
| 56002412               | FM1782MP        | STEEL     | -----             | 9               | EXT LG    | 477.8 x 338.6 x 4.7  | 18.81 x 13.33 x 0.185 |
| 56006630               | FM3679          | GRAPHITE  | SUNBURST          | 36              | INT TH    | 394.5 x 222.3 x 5.2  | 15.53 x 8.75 x 0.203  |
| 56006631               | FM1726MP        | STEEL     | -----             | 12              | EXT LG    | 414.3 x 254.0 x 4.7  | 16.31 x 10.0 x 0.185  |
| 56023743               | FM6864MP        | STEEL     | -----             | 24              | EXT LG    | 501.0 x 338.0 x 4.8  | 19.72 x 13.31 x 0.189 |
| 56025587               | FM5227          | CARBON PA | 2 PASS            | 60              | INT TH    | 195.1 x 145.0 x 4.0  | 7.68 x 5.71 x 0.156   |
| 56044065               | FM2733          | GRAPHITE  | SUNBURST          | 72              | INT TH    | 244.2 x 175.5 x 4.0  | 9.62 x 6.91 x 0.156   |
| 69040274               | FM4606MP        | STEEL     | -----             | 3               | EXT LG    | 216.9 x 144.0 x 2.7  | 8.54 x 5.67 x 0.106   |
| 77006538               | FM2215          | BRONZE    | SPR/WAG           | 22              | INT TH    | 204.5 x 53.3 x 4.8   | 8.05 x 2.1 x 0.19     |
| 77021036               | FM4625          | PAPER     | SUNBURST          | 16              | INT TH    | 201.0 x 40.5 x 4.9   | 7.91 x 1.59 x 0.192   |
| 77021037               | FM4606MP        | STEEL     | -----             | 3               | EXT LG    | 216.9 x 144.0 x 2.7  | 8.54 x 5.67 x 0.106   |

## TOYOTA

|                |          |        |          |    |           |                     |                     |
|----------------|----------|--------|----------|----|-----------|---------------------|---------------------|
| 32153-32381-71 | FM2931   | BRONZE | SUNBURST | 43 | INT TH    | 173.8 x 103.0 x 2.5 | 6.84 x 4.06 x 0.098 |
| 32158-33900-71 | FM3361   | PAPER  | WAFFLE   | 38 | INT TH    | 158.0 x 95.2 x 2.7  | 6.22 x 3.75 x 0.106 |
| 32159-33900-71 | FM3360MP | STEEL  | -----    | 64 | EXT TH    | 164.3 x 107.0 x 2.0 | 6.47 x 4.21 x 0.079 |
| 32343-30520-71 | FM3349   | PAPER  | 2 PASS   | 29 | INT TH    | 155.0 x 89.0 x 2.6  | 6.1 x 3.5 x 0.102   |
| 32344-30520-71 | FM3370MP | STEEL  | -----    | 52 | EXT TH    | 161.5 x 100.0 x 2.3 | 6.36 x 3.94 x 0.091 |
| 32411-23630-71 | FM3358MP | STEEL  | -----    | 6  | EXT LG    | 143.5 x 88.5 x 2.0  | 5.65 x 3.48 x 0.079 |
| 32412-22030-71 | FM2018MP | STEEL  | -----    | 12 | EXT LG    | 165.6 x 100.1 x 2.0 | 6.52 x 3.94 x 0.079 |
| 32412-23630-71 | FM3561   | PAPER  | WAFFLE   | 30 | INT TH    | 131.0 x 79.2 x 2.6  | 5.16 x 3.12 x 0.102 |
| 32412-33900-71 | FM3099   | PAPER  | 2 PASS   | 34 | INT TH    | 173.0 x 105.0 x 2.6 | 6.81 x 4.13 x 0.102 |
| 32413-31710-71 | FM3112MP | STEEL  | -----    | 18 | EXT LG    | 165.5 x 100.0 x 2.0 | 6.52 x 3.94 x 0.079 |
| 32416-23011-71 | FM4756MP | STEEL  | -----    | 28 | (35)EX TH | 139.0 x 91.2 x 1.6  | 5.47 x 3.59 x 0.063 |
| 32425-U2170-71 | FM4148MP | STEEL  | -----    | 8  | EXT LG    | 139.2 x 88.4 x 2.0  | 5.48 x 3.48 x 0.079 |
| 32425-23330-71 | FM4148MP | STEEL  | -----    | 8  | EXT LG    | 139.2 x 88.4 x 2.0  | 5.48 x 3.48 x 0.079 |
| 32431-12010-71 | FM2314MP | STEEL  | -----    | 8  | EXT LG    | 161.3 x 114.3 x 1.8 | 6.35 x 4.5 x 0.071  |
| 32431-10510-71 | FM2020MP | STEEL  | -----    | 8  | EXT LG    | 136.4 x 88.1 x 1.2  | 5.37 x 3.47 x 0.047 |
| 32431-12050-71 | FM2314MP | STEEL  | -----    | 8  | EXT LG    | 161.3 x 114.3 x 1.8 | 6.35 x 4.5 x 0.071  |
| 32431-22010-71 | FM4752MP | STEEL  | DISHED   | 8  | EXT LG    | 161.3 x 114.3 x 2.3 | 6.35 x 4.5 x 0.091  |
| 32431-23330-71 | FM4664MP | STEEL  | NOTCHES  | 6  | EXT LG    | 143.5 x 88.5 x 2.0  | 5.65 x 3.48 x 0.079 |
| 32431-23630-71 | FM3358MP | STEEL  | -----    | 6  | EXT LG    | 143.5 x 88.5 x 2.0  | 5.65 x 3.48 x 0.079 |

| REPLACES<br>OEM PT.NO. | FMC<br>PART NO. | MATERIAL | GROOVE<br>DETAILS | TEETH/<br>TANGS |           | SIZE MM |   |       | SIZE INCH |     |       |   |      |   |       |
|------------------------|-----------------|----------|-------------------|-----------------|-----------|---------|---|-------|-----------|-----|-------|---|------|---|-------|
| 32432-10510-71         | FM3704MP        | STEEL    | DISHED            | 8               | EXT LG    | 136.4   | x | 88.1  | x         | 1.2 | 5.37  | x | 3.47 | x | 0.047 |
| 32432-12010-71         | FM3735          | PAPER    | WAFFLE            | 30              | INT TH    | 131.0   | x | 79.2  | x         | 3.0 | 5.16  | x | 3.12 | x | 0.118 |
| 32432-12030-71         | FM2309          | PAPER    | 2 PASS            | 42              | INT TH    | 149.4   | x | 107.7 | x         | 2.6 | 5.88  | x | 4.24 | x | 0.102 |
| 32432-12050-71         | FM3737          | PAPER    | 2 PASS            | 42              | INT TH    | 149.4   | x | 107.7 | x         | 2.9 | 5.88  | x | 4.24 | x | 0.115 |
| 32432-12051-71         | FM3737          | PAPER    | 2 PASS            | 42              | INT TH    | 149.4   | x | 107.7 | x         | 2.9 | 5.88  | x | 4.24 | x | 0.115 |
| 32432-22010-71         | FM2129          | PAPER    | 2 PASS            | 37              | INT TH    | 155.7   | x | 87.9  | x         | 2.9 | 6.13  | x | 3.46 | x | 0.114 |
| 32432-22011-71         | FM2129          | PAPER    | 2 PASS            | 37              | INT TH    | 155.7   | x | 87.9  | x         | 2.9 | 6.13  | x | 3.46 | x | 0.114 |
| 32432-22030-71         | FM2131          | PAPER    | 2 PASS            | 37              | INT TH    | 155.7   | x | 87.9  | x         | 2.6 | 6.13  | x | 3.46 | x | 0.102 |
| 32432-23010-71         | FM3735          | PAPER    | WAFFLE            | 30              | INT TH    | 131.0   | x | 79.2  | x         | 3.0 | 5.16  | x | 3.12 | x | 0.118 |
| 32432-32890-71         | FM2131          | PAPER    | 2 PASS            | 37              | INT TH    | 155.7   | x | 87.9  | x         | 2.6 | 6.13  | x | 3.46 | x | 0.102 |
| 32433-10510-71         | FM2021OE        | BRONZE   | SUNBURST          | 30              | INT TH    | 124.5   | x | 79.2  | x         | 2.9 | 4.9   | x | 3.12 | x | 0.115 |
| 32439-23630-71         | FM4108MP        | STEEL    | DISHED            | 6               | EXT LG    | 143.3   | x | 88.3  | x         | 2.3 | 5.64  | x | 3.48 | x | 0.091 |
| 32442-12620-71         | FM2061          | PAPER    | WAFFLE            | 41              | INT TH    | 125.0   | x | 68.6  | x         | 2.6 | 4.92  | x | 2.7  | x | 0.102 |
| 32442-U1130-71         | FM2061          | PAPER    | WAFFLE            | 41              | INT TH    | 125.0   | x | 68.6  | x         | 2.6 | 4.92  | x | 2.7  | x | 0.102 |
| 32444-23330-71         | FM4108MP        | STEEL    | DISHED            | 6               | EXT LG    | 143.3   | x | 88.3  | x         | 2.3 | 5.64  | x | 3.48 | x | 0.091 |
| 32451-33060-71         | FM2314MP        | STEEL    | -----             | 8               | EXT LG    | 161.3   | x | 114.3 | x         | 1.9 | 6.35  | x | 4.5  | x | 0.075 |
| 32452-33060-71         | FM2309          | PAPER    | 2 PASS            | 42              | INT TH    | 149.4   | x | 107.7 | x         | 2.6 | 5.88  | x | 4.24 | x | 0.102 |
| 32461-23030-71         | FM2309          | PAPER    | 2 PASS            | 42              | INT TH    | 149.4   | x | 107.7 | x         | 2.6 | 5.88  | x | 4.24 | x | 0.102 |
| 32461-23330-71         | FM3561          | PAPER    | WAFFLE            | 30              | INT TH    | 131.0   | x | 79.2  | x         | 2.6 | 5.16  | x | 3.12 | x | 0.102 |
| 32461-23630-71         | FM3561          | PAPER    | WAFFLE            | 30              | INT TH    | 131.0   | x | 79.2  | x         | 2.6 | 5.16  | x | 3.12 | x | 0.102 |
| 32461-23830-71         | FM3561          | PAPER    | WAFFLE            | 30              | INT TH    | 131.0   | x | 79.2  | x         | 2.6 | 5.16  | x | 3.12 | x | 0.102 |
| 32461-F2100-71         | FM3561          | PAPER    | WAFFLE            | 30              | INT TH    | 131.0   | x | 79.2  | x         | 2.6 | 5.16  | x | 3.12 | x | 0.102 |
| 32482-33900-71         | FM3742MP        | STEEL    | -----             | 12              | EXT LG    | 183.4   | x | 118.0 | x         | 2.0 | 7.22  | x | 4.65 | x | 0.079 |
| 32551-31190-71         | FM3743          | BRONZE   | SUN/WAG           | 43              | INT TH    | 173.8   | x | 103.0 | x         | 2.5 | 6.84  | x | 4.06 | x | 0.098 |
| 35634-3400-A           | FM3561          | PAPER    | WAFFLE            | 30              | INT TH    | 131.0   | x | 79.2  | x         | 2.6 | 5.16  | x | 3.12 | x | 0.102 |
| 35634-3700             | FM3561          | PAPER    | WAFFLE            | 30              | INT TH    | 131.0   | x | 79.2  | x         | 2.6 | 5.16  | x | 3.12 | x | 0.102 |
| 40511-20060-71         | FM2063          | PAPER    | WAFFLE            | 41              | INT TH    | 125.0   | x | 68.6  | x         | 2.9 | 4.92  | x | 2.7  | x | 0.114 |
| 40512-20060-71         | FM2070MP        | STEEL    | -----             | 8               | EXT LG    | 131.6   | x | 77.2  | x         | 1.0 | 5.18  | x | 3.04 | x | 0.039 |
| 40516-40120-71         | FM7821          | OBSOLETE | SPR/RAD           | 43              | INT TH    | 173.8   | x | 103.0 | x         | 3.0 | 6.84  | x | 4.06 | x | 0.118 |
| 40517-40120-71         | FM2934MP        | STEEL    | BLACK             | 12              | EXT LG    | 183.4   | x | 118.0 | x         | 1.6 | 7.22  | x | 4.65 | x | 0.063 |
| 40521-30260-71         | FM2129          | PAPER    | 2 PASS            | 37              | INT TH    | 155.7   | x | 87.9  | x         | 2.9 | 6.13  | x | 3.46 | x | 0.114 |
| 40521-30261-71         | FM2131          | PAPER    | 2 PASS            | 37              | INT TH    | 155.7   | x | 87.9  | x         | 2.6 | 6.13  | x | 3.46 | x | 0.102 |
| 40521-30261-71         | FM3711          | BRONZE   | SUNBURST          | 37              | INT TH    | 155.7   | x | 87.9  | x         | 2.6 | 6.13  | x | 3.46 | x | 0.102 |
| 40522-30261-71         | FM2018MP        | STEEL    | -----             | 12              | EXT LG    | 165.6   | x | 100.1 | x         | 2.0 | 6.52  | x | 3.94 | x | 0.079 |
| 40586-40120-71         | FM2931          | BRONZE   | SUNBURST          | 43              | INT TH    | 173.8   | x | 103.0 | x         | 2.5 | 6.85  | x | 4.06 | x | 0.102 |
| 40587-40120-71         | FM3740MP        | STEEL    | BLACK             | 12              | EXT LG    | 183.4   | x | 118.0 | x         | 2.0 | 7.22  | x | 4.65 | x | 0.079 |
| 40615-20060-71         | FM1805          | BRONZE   | SUNBURST          | 41              | INT TH    | 125.0   | x | 68.6  | x         | 2.6 | 4.92  | x | 2.7  | x | 0.102 |
| 40615-20060-71         | FM2061          | PAPER    | WAFFLE            | 41              | INT TH    | 125.0   | x | 68.6  | x         | 2.6 | 4.92  | x | 2.7  | x | 0.102 |
| 40616-20060-71         | FM2074MP        | STEEL    | -----             | 8               | EXT LG    | 131.6   | x | 80.0  | x         | 1.6 | 5.18  | x | 3.15 | x | 0.063 |
| <b>TROJAN</b>          |                 |          |                   |                 |           |         |   |       |           |     |       |   |      |   |       |
| 6901324                | FM1195          | BRONZE   | SUNBURST          | 60              | INT TH    | 195.1   | x | 145.0 | x         | 4.0 | 7.68  | x | 5.71 | x | 0.156 |
| 6901705                | FM1218MP        | STEEL    | -----             | 16              | (24)EX TH | 257.3   | x | 190.5 | x         | 2.7 | 10.13 | x | 7.5  | x | 0.106 |
| 6901816                | FM1193          | GRAPHITE | SUNBURST          | 72              | INT TH    | 233.4   | x | 175.5 | x         | 4.0 | 9.19  | x | 6.91 | x | 0.156 |
| 6901914                | FM1191          | GRAPHITE | SUNBURST          | 60              | INT TH    | 195.1   | x | 145.0 | x         | 4.0 | 7.68  | x | 5.71 | x | 0.156 |



| REPLACES<br>OEM PT.NO. | FMC<br>PART NO. | MATERIAL             | GROOVE<br>DETAILS | TEETH/<br>TANGS | SIZE MM |       |   |       | SIZE INCH |     |       |   |      |   |       |
|------------------------|-----------------|----------------------|-------------------|-----------------|---------|-------|---|-------|-----------|-----|-------|---|------|---|-------|
| <b>TUG</b>             |                 |                      |                   |                 |         |       |   |       |           |     |       |   |      |   |       |
| TP-10271               | FM2969          | BRONZE               | WAFFLE            | 22              | INT TH  | 71.7  | x | 44.0  | x         | 1.6 | 2.82  | x | 1.73 | x | 0.063 |
| <b>TWIN DISC</b>       |                 |                      |                   |                 |         |       |   |       |           |     |       |   |      |   |       |
| 2215E                  | FM6733          | BRONZE               | WAFFLE            | 6               | EXT LG  | 84.0  | x | 63.5  | x         | 2.5 | 3.31  | x | 2.5  | x | 0.098 |
| B3060A                 | FM3565          | BRONZE               | RADIAL            | 68              | EXT TH  | 112.3 | x | 71.3  | x         | 2.1 | 4.42  | x | 2.81 | x | 0.083 |
| 3771G                  | FM8441          | BRONZE               | -----             | 12              | EXT LG  | 166.5 | x | 116.0 | x         | 2.2 | 6.56  | x | 4.57 | x | 0.085 |
| P3924D                 | FM9377          | PAPER                | WAFFLE            | 64              | EXT TH  | 138.4 | x | 95.0  | x         | 2.4 | 5.45  | x | 3.74 | x | 0.093 |
| P4251A,B,C             | FM1801          | BRONZE               | WAFFLE            | 76              | EXT TH  | 164.1 | x | 103.1 | x         | 2.8 | 6.46  | x | 4.06 | x | 0.11  |
| P4366                  | FM5123          | BRONZE               | WAFFLE            | 88              | EXT TH  | 189.5 | x | 117.6 | x         | 3.1 | 7.46  | x | 4.63 | x | 0.122 |
| P4371                  | FM1660MP        | STEEL                | -----             | 45              | INT TH  | 152.4 | x | 92.5  | x         | 1.5 | 6.0   | x | 3.64 | x | 0.06  |
| P4372                  | FM4074MP        | STEEL                | -----             | 42              | INT TH  | 101.6 | x | 64.8  | x         | 1.6 | 4.0   | x | 2.55 | x | 0.063 |
| P4373                  |                 | OBSOLETE AFTER STOCK |                   | 52              | INT TH  | 177.8 | x | 106.7 | x         | 2.4 | 7.0   | x | 4.2  | x | 0.094 |
| A4480A,B,M             | FM1801          | BRONZE               | WAFFLE            | 76              | EXT TH  | 164.1 | x | 103.1 | x         | 2.8 | 6.46  | x | 4.06 | x | 0.11  |
| A4480G                 | FM3733          | BRONZE               | SUNBURST          | 76              | EXT TH  | 164.0 | x | 103.0 | x         | 2.9 | 6.46  | x | 4.06 | x | 0.114 |
| A4481A                 | FM1220MP        | STEEL                | -----             | 40              | INT TH  | 152.4 | x | 82.3  | x         | 1.6 | 6.0   | x | 3.24 | x | 0.063 |
| A4488                  | FM5123          | BRONZE               | WAFFLE            | 88              | EXT TH  | 189.5 | x | 117.6 | x         | 3.1 | 7.46  | x | 4.63 | x | 0.122 |
| A4939                  | FM1660MP        | STEEL                | -----             | 45              | INT TH  | 152.4 | x | 92.5  | x         | 1.5 | 6.0   | x | 3.64 | x | 0.06  |
| A6566E                 | FM2605          | BRONZE               | SPR/RAD           | 12              | EXT LG  | 236.0 | x | 139.7 | x         | 3.1 | 9.29  | x | 5.5  | x | 0.122 |
| A6567                  | FM1732MP        | STEEL                | -----             | 40              | INT TH  | 203.2 | x | 122.8 | x         | 2.3 | 8.0   | x | 4.83 | x | 0.091 |
| A6567-E                | FM2638MP        | STEEL                | -----             | 40              | INT TH  | 203.2 | x | 122.9 | x         | 4.7 | 8.0   | x | 4.84 | x | 0.185 |
| P4374A,B               | FM2398MP        | STEEL                | DISHED            | 56              | INT TH  | 203.2 | x | 138.4 | x         | 2.3 | 8.0   | x | 5.45 | x | 0.091 |
| P5389                  | FM3508MP        | STEEL                | DISHED            | 40              | INT TH  | 127.0 | x | 82.3  | x         | 1.6 | 5.0   | x | 3.24 | x | 0.063 |
| P8381                  | FM4695          | BRONZE               | WAFFLE            | 72              | EXT TH  | 116.8 | x | 75.9  | x         | 2.2 | 4.6   | x | 2.99 | x | 0.087 |
| P8382                  | FM4698MP        | STEEL                | -----             | 45              | INT TH  | 108.2 | x | 68.9  | x         | 1.6 | 4.26  | x | 2.71 | x | 0.063 |
| 204097                 | FM4074MP        | STEEL                | -----             | 42              | INT TH  | 101.6 | x | 64.8  | x         | 1.6 | 4.0   | x | 2.55 | x | 0.063 |
| 215736                 | OBSOLETE        | STEEL                | -----             | 56              | INT TH  | 203.2 | x | 138.7 | x         | 2.3 | 8.0   | x | 5.46 | x | 0.091 |
| 225102                 | FM4468MP        | OBSOLETE AFTER STOCK |                   | 90              | INT TH  | 316.0 | x | 225.0 | x         | 2.2 | 12.44 | x | 8.86 | x | 0.085 |
| 205105C                | FM2395B         | BRONZE               | SUNBURST          | 100             | EXT TH  | 214.6 | x | 151.6 | x         | 3.1 | 8.45  | x | 5.97 | x | 0.122 |
| 206063C                | FM2704MP        | STEEL                | -----             | 64              | INT TH  | 228.6 | x | 158.7 | x         | 2.6 | 9.0   | x | 6.25 | x | 0.102 |
| 206067C,T              | FM2705B         | BRONZE               | SUNBURST          | 93              | EXT TH  | 239.8 | x | 171.6 | x         | 3.5 | 9.44  | x | 6.76 | x | 0.138 |
| 206067J,Z              | FM3687          | PAPER                | WAFFLE            | 93              | EXT TH  | 239.8 | x | 171.6 | x         | 3.6 | 9.44  | x | 6.76 | x | 0.142 |
| 206106C,K,P            | FM2395B         | BRONZE               | SUNBURST          | 100             | EXT TH  | 214.6 | x | 151.6 | x         | 3.1 | 8.45  | x | 5.97 | x | 0.122 |
| 206106X,Y              | FM3691          | PAPER                | WAFFLE            | 100             | EXT TH  | 214.6 | x | 151.4 | x         | 3.2 | 8.45  | x | 5.96 | x | 0.125 |
| 206107B                | FM2398MP        | STEEL                | DISHED            | 56              | INT TH  | 203.2 | x | 138.7 | x         | 2.3 | 8.0   | x | 5.46 | x | 0.091 |
| 206177A,M,N            | FM2707          | BRONZE               | WAFFLE            | 88              | EXT TH  | 189.4 | x | 141.7 | x         | 3.1 | 7.46  | x | 5.58 | x | 0.122 |
| 206177S                | FM8803          | PAPER                | WAFFLE            | 88              | EXT TH  | 189.6 | x | 141.7 | x         | 3.2 | 7.46  | x | 5.58 | x | 0.125 |
| 206178D                | FM2710MP        | STEEL                | -----             | 52              | INT TH  | 177.8 | x | 128.2 | x         | 2.3 | 7.0   | x | 5.05 | x | 0.091 |
| 225103E                | FM4465          | OBSOLETE AFTER STOCK |                   | 129             | EXT TH  | 332.5 | x | 240.0 | x         | 3.3 | 13.09 | x | 9.45 | x | 0.13  |

| REPLACES<br>OEM PT.NO.          | FMC<br>PART NO. | MATERIAL     | GROOVE<br>DETAILS | TEETH/<br>TANGS | SIZE MM    | SIZE INCH                                 |
|---------------------------------|-----------------|--------------|-------------------|-----------------|------------|---|
| <b>UNIVERSAL TRACTOR BRASOV</b> |                 |              |                   |                 |            |   |
| 33 16050                        | FM1619          | BRONZE       | SPR/WAG           | 94              | INT TH     | 444.5 x 295.5 x 7.1 17.5 x 11.63 x 0.28   |
| 33 24015                        | FM1603          | BRONZE       | -----             | 120             | EXT TH     | 384.8 x 292.6 x 4.7 15.15 x 11.52 x 0.187 |
| <b>UZEL</b>                     |                 |              |                   |                 |            |   |
| 0012164U1M                      | FM2971          | BRONZE       | WAFFLE            | 22              | INT TH     | 71.7 x 44.0 x 2.8 2.82 x 1.73 x 0.11      |
| 0012165U1M                      | FM3474MP        | STEEL        | -----             | 4               | EXT LG     | 85.0 x 49.2 x 1.5 3.35 x 1.94 x 0.059     |
| 0012166U1M                      | FM2969          | BRONZE       | WAFFLE            | 22              | INT TH     | 71.7 x 44.0 x 1.6 2.82 x 1.73 x 0.063     |
| <b>VALMET / VALTRA</b>          |                 |              |                   |                 |            |   |
| 411040                          | FM1204MP        | STEEL        | -----             | 1               | EXT LG     | 228.6 x 127.0 x 2.7 9.0 x 5.0 x 0.106     |
| 633165                          | FM2969          | BRONZE       | WAFFLE            | 22              | INT TH     | 71.7 x 44.0 x 1.6 2.82 x 1.73 x 0.063     |
| 633170                          | FM3474MP        | STEEL        | -----             | 4               | EXT LG     | 85.0 x 49.2 x 1.5 3.35 x 1.94 x 0.059     |
| 633175                          | FM2971          | BRONZE       | WAFFLE            | 22              | INT TH     | 71.7 x 44.0 x 2.8 2.82 x 1.73 x 0.11      |
| 5007913                         | FM8993          | BRONZE       | WAFFLE            | 95              | EXT TH     | 287.0 x 167.0 x 4.0 11.3 x 6.57 x 0.157   |
| 30184800                        | FM1707          | BRONZE       | SPR/WAG           | 27              | INT TH     | 224.0 x 55.1 x 4.8 8.82 x 2.17 x 0.19     |
| 30359700                        | FM1204MP        | STEEL        | -----             | 1               | EXT LG     | 228.6 x 127.0 x 2.7 9.0 x 5.0 x 0.106     |
| 30721000                        | FM2277          | BRONZE       | SUNBURST          | 27              | EXT TH     | 137.4 x 90.9 x 2.0 5.41 x 3.58 x 0.079    |
| 30727800                        | FM3596MP        | STEEL        | -----             | 29              | INT TH     | 131.1 x 85.1 x 2.5 5.16 x 3.35 x 0.098    |
| 30727900                        | FM3592MP        | STEEL        | -----             | 29              | INT TH     | 131.1 x 85.1 x 1.5 5.16 x 3.35 x 0.059    |
| 30728100                        | FM3594MP        | STEEL        | -----             | 29              | INT TH     | 131.1 x 85.1 x 2.0 5.16 x 3.35 x 0.079    |
| 30902500                        | FM4015          | GRAPHITE     | SUNBURST          | 27              | INT TH     | 303.8 x 66.1 x 10.0 11.96 x 2.6 x 0.393   |
| 32584900                        | FM1190MP        | STEEL        | -----             | 1               | EXT LG     | 228.6 x 127.0 x 2.6 9.0 x 5.0 x 0.102     |
| 32618700                        | FM4251          | PAPER        | WAFFLE            | 45              | INT TH     | 133.1 x 92.7 x 1.9 5.24 x 3.65 x 0.73     |
| 32773200                        | FM1324MP        | STEEL        | -----             | 54              | EXT TH     | 139.2 x 98.6 x 1.8 5.48 x 3.88 x 0.07     |
| 32800600                        | FM7763          | PAPER        | WAFFLE            | 15              | INT TH     | 223.0 x 41.0 x 4.8 8.78 x 1.61 x 0.187    |
| 34123900                        | FM8970MP        | STEEL        | -----             | 1               | EXT SL     | 228.6 x 149.0 x 4.5 8.82 x 5.87 x 0.177   |
| 34164300                        | FM6239KIT       | 9 x PAPER    | 9 x STEEL         |                 |            |   |
| 34164400                        | KIT             | 9 X FM1324MP | 9 X FM4251        |                 |            |   |
| 34164500                        | KIT             | 7 X FM1324MP | 7 X FM4251        |                 |            |   |
| 34164600                        | KIT             | 6 X FM6242MP | 6 X FM4251        |                 |            |   |
| 34401400                        | FM7391          | PAPER        | WAFFLE            | 27              | INT TH     | 224.0 x 55.1 x 4.8 8.82 x 2.17 x 0.189    |
| 35031000                        | FM3602MP        | STEEL        | -----             | 35              | INT TH     | 170.9 x 102.9 x 2.0 6.73 x 4.05 x 0.079   |
| 35102500                        | FM7692MP        | STEEL        | SINEWAVED         | 47              | (48)INT TH | 198.0 x 131.6 x 2.8 7.8 x 5.18 x 0.11     |
| 35178000                        | KIT             | 5 X PAPER    | 2 X SINGLE SIDED  |                 | 6 X STEELS |   |
| 45037300                        | FM3222MP        | STEEL        | -----             | 1               | EXT LG     | 228.6 x 127.0 x 2.7 9.0 x 5.0 x 0.106     |
| 70029600                        | FM6242MP        | STEEL        | -----             | 6               | EXT LG     | 143.1 x 99.3 x 1.5 5.63 x 3.91 x 0.059    |
| 81236600                        | FM3474MP        | STEEL        | -----             | 4               | EXT LG     | 85.0 x 49.2 x 1.5 3.35 x 1.94 x 0.059     |
| 81236700                        | FM2969          | BRONZE       | WAFFLE            | 22              | INT TH     | 71.7 x 44.0 x 1.6 2.82 x 1.73 x 0.063     |
| 802311013                       | FM4349          | PAPER        | WAFFLE            | 42              | INT TH     | 340.0 x 206.0 x 5.5 13.39 x 8.11 x 0.217  |
| 802311014                       | FM3006MP        | STEEL        | -----             | 70              | EXT TH     | 358.0 x 229.0 x 5.0 14.09 x 9.02 x 0.197  |
| 922011125                       | FM1324MP        | STEEL        | -----             | 54              | EXT TH     | 139.2 x 98.6 x 1.8 5.48 x 3.88 x 0.07     |
| 922011130                       | FM1337OE        | BRONZE       | RADIAL            | 45              | INT TH     | 133.1 x 92.7 x 2.3 5.24 x 3.65 x 0.09     |
| 1479110130                      | FM4507          | BRONZE       | WAFFLE            | 76              | EXT TH     | 164.0 x 132.0 x 2.1 6.46 x 5.2 x 0.083    |
| 1479130120                      | FM9082MP        | STEEL        | HARDENED          | 41              | EXT TH     | 84.5 x 56.0 x 1.0 3.33 x 2.2 x 0.39       |
| 1479130130                      | FM4510MP        | STEEL        | -----             | 31              | INT TH     | 154.0 x 125.0 x 1.5 6.06 x 4.92 x 0.059   |
| M2211064H                       | FM1707          | BRONZE       | SPR/WAG           | 27              | INT TH     | 224.0 x 55.1 x 4.8 8.82 x 2.17 x 0.19     |
| M2211065H                       | FM1204MP        | STEEL        | -----             | 1               | EXT LG     | 228.6 x 127.0 x 2.7 9.0 x 5.0 x 0.106     |

| REPLACES<br>OEM PT.NO. | FMC<br>PART NO. | MATERIAL  | GROOVE<br>DETAILS | TEETH/<br>TANGS | SIZE MM |       |   | SIZE INCH |   |      |       |   |       |   |       |
|------------------------|-----------------|-----------|-------------------|-----------------|---------|-------|---|-----------|---|------|-------|---|-------|---|-------|
| <b>VENIERI</b>         |                 |           |                   |                 |         |       |   |           |   |      |       |   |       |   |       |
| 241.0.043              | FM4015          | GRAPHITE  | SUNBURST          | 27              | INT TH  | 303.8 | x | 66.1      | x | 10.0 | 11.96 | x | 2.6   | x | 0.393 |
| 241.3.007              | FM2971          | BRONZE    | WAFFLE            | 22              | INT TH  | 71.7  | x | 44.0      | x | 2.8  | 2.82  | x | 1.73  | x | 0.11  |
| 241.3.008              | FM2969          | BRONZE    | WAFFLE            | 22              | INT TH  | 71.7  | x | 44.0      | x | 1.6  | 2.82  | x | 1.73  | x | 0.063 |
| 241.3.009              | FM3474MP        | STEEL     | -----             | 4               | EXT LG  | 85.0  | x | 49.2      | x | 1.5  | 3.35  | x | 1.94  | x | 0.059 |
| 241.3.013              | FM9485          | GRAPHITE  | SUNBURST          | 12              | INT TH  | 170.0 | x | 32.7      | x | 4.8  | 6.69  | x | 1.29  | x | 0.189 |
| 242.5.030              | FM2777          | GRAPHITE  | SUNBURST          | 27              | INT TH  | 260.0 | x | 66.1      | x | 10.0 | 10.24 | x | 2.6   | x | 0.394 |
| <b>VOITH</b>           |                 |           |                   |                 |         |       |   |           |   |      |       |   |       |   |       |
| 40.1046.30             | FM6622MP        | STEEL     | -----             | 12              | EXT SL  | 339.4 | x | 244.1     | x | 2.6  | 13.36 | x | 9.61  | x | 0.102 |
| 48.0133.23             | FM4517          | BRONZE    | RAD/2 PASS        | 58              | INT TH  | 317.0 | x | 232.0     | x | 4.0  | 12.48 | x | 9.13  | x | 0.157 |
| 50.2982.04             | FM5842MP        | STEEL     | -----             | 12              | EXT LG  | 288.0 | x | 233.0     | x | 2.0  | 11.34 | x | 9.17  | x | 0.079 |
| 50.5153.13             | FM5846MP        | STEEL     | -----             | 63              | INT TH  | 317.5 | x | 250.2     | x | 3.5  | 12.5  | x | 9.85  | x | 0.098 |
| 50.5520.11             | FM1734MP        | STEEL     | SINEWAVED         | 12              | EXT LG  | 340.0 | x | 264.0     | x | 2.5  | 13.39 | x | 10.24 | x | 0.098 |
| 50.5520.14             | FM1734MP        | STEEL     | SINEWAVED         | 12              | EXT LG  | 340.0 | x | 264.0     | x | 2.5  | 13.39 | x | 10.24 | x | 0.098 |
| 50.7147.16             | FM1467          | PAPER     | CONCENTRIC        | 63              | INT TH  | 317.5 | x | 250.2     | x | 3.5  | 12.5  | x | 9.85  | x | 0.137 |
| 50.7147.17             | FM1467          | PAPER     | CONCENTRIC        | 63              | INT TH  | 317.5 | x | 250.2     | x | 3.5  | 12.5  | x | 9.85  | x | 0.137 |
| 50.7493.10             | FM8560-2.0      | OBSOLETE  | -----             | 8               | EXT LG  | 242.1 | x | 170.4     | x | 2.0  | 9.53  | x | 6.71  | x | 0.079 |
| 50.7715.20             | FM1736MP        | STEEL     | -----             | 12              | EXT LG  | 299.0 | x | 207.0     | x | 3.0  | 11.77 | x | 8.15  | x | 0.118 |
| 50.7910.10             | FM8560-5.0      | OBSOLETE  | -----             | 8               | EXT LG  | 243.3 | x | 169.8     | x | 5.0  | 9.58  | x | 6.69  | x | 0.197 |
| 50.7920.10             | FM1738MP        | STEEL     | SINEWAVED         | 12              | EXT LG  | 280.0 | x | 207.0     | x | 2.0  | 11.02 | x | 8.15  | x | 0.08  |
| 50.8935.12             | FM4758MP        | STEEL     | -----             | 34              | EXT TH  | 139.0 | x | 97.0      | x | 1.5  | 5.47  | x | 3.82  | x | 0.059 |
| 50.9743.13             | FM1740MP        | STEEL     | NITRIDED          | 12              | EXT LG  | 340.0 | x | 264.0     | x | 2.5  | 13.39 | x | 10.24 | x | 0.098 |
| 52.6303.10             | FM1736B         | STEEL     | -----             | 12              | EXT LG  | 299.0 | x | 207.0     | x | 3.0  | 11.77 | x | 8.15  | x | 0.118 |
| 52.6306.10             | FM1738B         | STEEL     | -----             | 12              | EXT LG  | 280.0 | x | 207.0     | x | 3.5  | 11.02 | x | 8.15  | x | 0.137 |
| 52.6804.10             | FM4758MP        | STEEL     | -----             | 34              | EXT TH  | 139.0 | x | 97.0      | x | 1.5  | 5.47  | x | 3.82  | x | 0.059 |
| 54.8208.10             | FM5054MP        | END PLATE | STEPPED           | 12              | EXT LG  | 280.0 | x | 207.0     | x | 7.0  | 11.02 | x | 8.15  | x | 0.276 |
| 54.9141.10             | FM1734MP        | STEEL     | SINEWAVED         | 12              | EXT LG  | 340.0 | x | 264.0     | x | 2.5  | 13.39 | x | 10.24 | x | 0.098 |
| 54.9141.16             | FM1734MP        | STEEL     | SINEWAVED         | 12              | EXT LG  | 340.0 | x | 264.0     | x | 2.5  | 13.39 | x | 10.24 | x | 0.098 |
| 58.2182.10             | FM5843          | PAPER     | 2 PASS            | 12              | EXT LG  | 340.0 | x | 264.0     | x | 3.3  | 13.39 | x | 10.39 | x | 0.13  |
| 58.2250.10             | FM7813          | BRONZE    | RADIAL            | 63              | INT TH  | 317.5 | x | 250.2     | x | 3.5  | 12.5  | x | 9.85  | x | 0.137 |
| 58.2250.12             | FM7813          | BRONZE    | RADIAL            | 63              | INT TH  | 317.5 | x | 250.2     | x | 3.5  | 12.5  | x | 9.85  | x | 0.137 |
| 58.2250.13             | FM7813          | BRONZE    | RADIAL            | 63              | INT TH  | 317.5 | x | 250.2     | x | 3.5  | 12.5  | x | 9.85  | x | 0.137 |
| 58.2305.10             | FM5839          | PAPER     | 2 PASS            | 56              | INT TH  | 268.0 | x | 221.0     | x | 3.3  | 10.55 | x | 8.7   | x | 0.13  |
| 58.2305.11             | FM5839          | PAPER     | 2 PASS            | 56              | INT TH  | 268.0 | x | 221.0     | x | 3.3  | 10.55 | x | 8.7   | x | 0.13  |
| 58.2460.13             | FM1493          | PAPER     | 2 PASS            | 50              | INT TH  | 257.6 | x | 197.1     | x | 3.0  | 10.14 | x | 7.76  | x | 0.118 |
| 58.2460.14             | FM1493          | PAPER     | 2 PASS            | 50              | INT TH  | 257.6 | x | 197.1     | x | 3.0  | 10.14 | x | 7.76  | x | 0.118 |
| 58.2526.13             | FM1467          | PAPER     | CONCENTRIC        | 63              | INT TH  | 317.5 | x | 250.2     | x | 3.5  | 12.5  | x | 9.85  | x | 0.137 |
| 58.2924.20             | FM6911          | BRONZE    | SPR/RAD           | 41              | INT TH  | 221.8 | x | 162.1     | x | 3.5  | 8.73  | x | 6.38  | x | 0.138 |
| 58.3965.04             | FM4245          | PAPER     | 2 PASS            | 30              | INT TH  | 130.0 | x | 89.2      | x | 2.5  | 5.12  | x | 3.51  | x | 0.098 |
| 58.3965.10             | FM4245          | PAPER     | 2 PASS            | 30              | INT TH  | 130.0 | x | 89.2      | x | 2.5  | 5.12  | x | 3.51  | x | 0.098 |
| 58.4150.12             | FM1465          | PAPER     | 4 PASS            | 50              | INT TH  | 257.6 | x | 197.1     | x | 3.2  | 10.14 | x | 7.76  | x | 0.126 |
| 58.4150.13             | FM1465          | PAPER     | 4 PASS            | 50              | INT TH  | 257.6 | x | 197.1     | x | 3.2  | 10.14 | x | 7.76  | x | 0.126 |
| 68.3001.13             | FM1465          | PAPER     | 4 PASS            | 50              | INT TH  | 257.6 | x | 197.1     | x | 3.2  | 10.14 | x | 7.76  | x | 0.126 |
| 15000307210            | FM7811          | PAPER     | CONCENTRIC        | 63              | INT TH  | 317.5 | x | 250.2     | x | 3.5  | 12.5  | x | 9.85  | x | 0.137 |
| 15000307211            | FM7811          | PAPER     | CONCENTRIC        | 63              | INT TH  | 317.5 | x | 250.2     | x | 3.5  | 12.5  | x | 9.85  | x | 0.137 |
| 15000349611            | FM1493          | PAPER     | 2 PASS            | 50              | INT TH  | 257.6 | x | 197.1     | x | 3.0  | 10.14 | x | 7.76  | x | 0.118 |
| 15000411510            | FM7809          | PAPER     | 4 PASS            | 50              | INT TH  | 257.6 | x | 197.1     | x | 3.2  | 10.14 | x | 7.76  | x | 0.126 |

| REPLACES<br>OEM PT.NO. | FMC<br>PART NO. | MATERIAL | GROOVE<br>DETAILS | TEETH/<br>TANGS | SIZE MM             | SIZE INCH           |
|------------------------|-----------------|----------|-------------------|-----------------|---------------------|---------------------|
| 15000557310            | FM7813          | BRONZE   | RADIAL            | 63 INT TH       | 317.5 x 250.2 x 3.5 | 12.5 x 9.85 x 0.137 |
| 15000557311            | FM7813          | BRONZE   | RADIAL            | 63 INT TH       | 317.5 x 250.2 x 3.5 | 12.5 x 9.85 x 0.137 |
| 15000910310            | FM7811          | PAPER    | CONCENTRIC        | 63 INT TH       | 317.5 x 250.2 x 3.5 | 12.5 x 9.85 x 0.137 |
| 15001259110            | FM7811          | PAPER    | CONCENTRIC        | 63 INT TH       | 317.5 x 250.2 x 3.5 | 12.5 x 9.85 x 0.137 |

| REPLACES OEM PT.NO. | FMC PART NO. | MATERIAL | GROOVE DETAILS | TEETH/TANGS | SIZE MM | SIZE INCH |
|---------------------|--------------|----------|----------------|-------------|---------|-----------|
|---------------------|--------------|----------|----------------|-------------|---------|-----------|

**VOLVO (also see Clark and Samsung)**

|             |            |           |          |    |           |                     |                       |
|-------------|------------|-----------|----------|----|-----------|---------------------|-----------------------|
| 242716      | FM2737     | GRAPHITE  | SUNBURST | 60 | INT TH    | 212.6 x 145.0 x 4.0 | 8.37 x 5.71 x 0.156   |
| 326019      | FM1222MP   | STEEL     | -----    | 44 | INT TH    | 198.1 x 125.7 x 3.0 | 7.8 x 4.95 x 0.118    |
| 355402      | FM1113     | BRONZE    | SPIRAL   | 69 | EXT TH    | 210.8 x 142.2 x 3.2 | 8.3 x 5.6 x 0.125     |
| 795322-7    | FM1262MP   | STEEL     | -----    | 8  | EXT LG    | 142.5 x 99.1 x 1.6  | 5.61 x 3.9 x 0.063    |
| 1171216     | FM1193     | GRAPHITE  | SUNBURST | 72 | INT TH    | 233.4 x 175.5 x 4.0 | 9.19 x 6.91 x 0.156   |
| 1528081-1   | FM2613     | PAPER     | 2 PASS   | 30 | INT TH    | 182.4 x 129.5 x 2.5 | 7.18 x 5.1 x 0.098    |
| 1529044     | FM2793     | PAPER     | 2 PASS   | 71 | INT TH    | 275.3 x 222.3 x 3.2 | 10.84 x 8.75 x 0.125  |
| 1650310-4   | FM3758MP   | STEEL     | -----    | 48 | EXT TH    | 232.0 x 171.0 x 2.5 | 9.13 x 6.73 x 0.098   |
| 1650313-8   | FM3770MP   | STEEL     | -----    | 31 | (32)EX TH | 350.0 x 265.5 x 2.5 | 13.78 x 10.45 x 0.098 |
| 1650314-6   | FM3774MP   | STEEL     | -----    | 31 | (32)EX TH | 349.5 x 277.5 x 2.5 | 13.76 x 10.92 x 0.098 |
| 1650317-9   | FM3772MP   | STEEL     | -----    | 31 | (32)EX TH | 350.0 x 265.5 x 3.0 | 13.78 x 10.45 x 0.118 |
| 1650318-7   | FM3776MP   | STEEL     | -----    | 31 | (32)EX TH | 349.5 x 277.5 x 3.0 | 13.76 x 10.92 x 0.118 |
| 1650320-3   | FM3501     | PAPER     | 2 PASS   | 65 | INT TH    | 218.0 x 162.0 x 2.8 | 8.58 x 6.38 x 0.11    |
| 1650322     | FM3753     | PAPER     | 2 PASS   | 50 | INT TH    | 315.0 x 246.5 x 3.7 | 12.4 x 9.7 x 0.146    |
| 1650323-7   | FM3755     | PAPER     | 2 PASS   | 54 | INT TH    | 328.0 x 265.0 x 3.7 | 12.91 x 10.43 x 0.146 |
| 1650357-5   | FM3768MP   | STEEL     | -----    | 31 | (32)EX TH | 337.0 x 265.5 x 3.5 | 13.27 x 10.45 x 0.138 |
| 1650358-3   | FM3762MP   | STEEL     | -----    | 30 | (32)EX TH | 315.0 x 247.0 x 2.5 | 12.4 x 9.72 x 0.098   |
| 1650388-0   | FM3751     | PAPER     | 2 PASS   | 96 | INT TH    | 294.0 x 240.0 x 3.8 | 11.57 x 9.45 x 0.15   |
| 1650996-0   | FM3766MP   | STEEL     | -----    | 31 | (32)EX TH | 337.0 x 265.5 x 3.0 | 13.27 x 10.45 x 0.118 |
| 1663310     | FM3974MP   | STEEL     | -----    | 32 | INT TH    | 163.0 x 94.0 x 2.5  | 6.41 x 3.69 x 0.098   |
| 1663327     | FM3978MP   | STEEL     | -----    | 34 | (45)EX TH | 281.0 x 221.0 x 2.5 | 11.05 x 8.7 x 0.098   |
| 1663345     | FM3990MP   | STEEL     | HOLES    | 24 | (32)EX TH | 306.0 x 237.0 x 2.5 | 12.03 x 9.3 x 0.098   |
| 1663360     | FM3982MP   | STEEL     | -----    | 24 | (32)EX TH | 306.0 x 237.0 x 2.0 | 12.03 x 9.3 x 0.079   |
| 3095765     | FM4488MP   | STEEL     | -----    | 24 | (32)EX TH | 306.0 x 237.0 x 3.5 | 12.03 x 9.3 x 0.137   |
| 3097480     | FM5304-3.5 | STEEL     | -----    | 8  | EXT LG    | 417.6 x 354.0 x 3.5 | 16.44 x 14.33 x 0.138 |
| 3097481     | FM5304-3.0 | STEEL     | -----    | 8  | EXT LG    | 417.6 x 354.0 x 3.0 | 16.44 x 14.33 x 0.118 |
| 3097482     | FM5277     | PAPER     | RADIAL   | 36 | INT LG    | 390.0 x 345.0 x 3.1 | 15.35 x 13.58 x 0.122 |
| 4095205     | FM1278MP   | STEEL     | -----    | 14 | (20)EX TH | 218.9 x 158.8 x 2.7 | 8.62 x 6.25 x 0.106   |
| 4095206     | FM1195     | BRONZE    | SUNBURST | 60 | INT TH    | 195.1 x 145.0 x 4.0 | 7.68 x 5.71 x 0.156   |
| 4095404     | OBSOLETE   | BACKPLATE | 24 HOLES |    |           | 457.0 x 393.0 x 4.0 | 17.99 x 15.47 x 0.157 |
| 4095411     | FM2727     | GRAPHITE  | SUNBURST | 80 | INT TH    | 326.9 x 247.9 x 5.5 | 12.87 x 9.76 x 0.216  |
| 6231576     | FM1387     | BRONZE    | SPR/WAG  | 17 | INT TH    | 224.0 x 50.8 x 4.9  | 8.82 x 2.0 x 0.193    |
| 6231577     | FM1204MP   | STEEL     | -----    | 1  | EXT LG    | 228.6 x 127.0 x 2.7 | 9.0 x 5.0 x 0.106     |
| 6609821     | FM8441     | BRONZE    | -----    | 12 | EXT LG    | 166.5 x 116.0 x 2.2 | 6.56 x 4.57 x 0.085   |
| 6609822     | FM8444MP   | STEEL     | DISHED   | 6  | INT SL    | 152.4 x 89.5 x 1.6  | 6.0 x 3.52 x 0.063    |
| 8551061     | FM3982MP   | STEEL     | -----    | 24 | (32)EX TH | 306.0 x 237.0 x 2.0 | 12.03 x 9.3 x 0.079   |
| 4.715.178   | FM5796MP   | STEEL     | -----    | 40 | INT TH    | 152.0 x 81.5 x 1.5  | 5.98 x 3.21 x 0.059   |
| 4715178     | FM5796MP   | STEEL     | -----    | 40 | INT TH    | 152.0 x 81.5 x 1.5  | 5.98 x 3.21 x 0.059   |
| 4.718.216   | FM4967     | BRONZE    | -----    | 76 | EXT TH    | 164.0 x 89.0 x 2.9  | 6.46 x 3.5 x 0.114    |
| 4718216     | FM4967     | BRONZE    | -----    | 76 | EXT TH    | 164.0 x 89.0 x 2.9  | 6.46 x 3.5 x 0.114    |
| 4.720.762-6 | FM3088MP   | STEEL     | -----    | 45 | INT TH    | 155.0 x 92.7 x 2.0  | 6.1 x 3.65 x 0.079    |
| 4720762     | FM3088MP   | STEEL     | -----    | 45 | INT TH    | 155.0 x 92.7 x 2.0  | 6.1 x 3.65 x 0.079    |
| 4.720.763-4 | FM3090MP   | STEEL     | -----    | 45 | INT TH    | 155.0 x 92.7 x 1.5  | 6.1 x 3.65 x 0.061    |
| 4720763     | FM3090MP   | STEEL     | -----    | 45 | INT TH    | 155.0 x 92.7 x 1.5  | 6.1 x 3.65 x 0.061    |
| 4.720.764-2 | FM3091     | BRONZE    | RAD/WAG  | 76 | EXT TH    | 164.0 x 99.3 x 2.0  | 6.46 x 3.91 x 0.079   |
| 4720764     | FM3091     | BRONZE    | RAD/WAG  | 76 | EXT TH    | 164.0 x 99.3 x 2.0  | 6.46 x 3.91 x 0.079   |
| 4.720.765-9 | FM3091     | BRONZE    | RAD/WAG  | 76 | EXT TH    | 164.0 x 99.3 x 2.0  | 6.46 x 3.91 x 0.079   |



# Volvo Transmission Discs

---



| REPLACES<br>OEM PT.NO. | FMC<br>PART NO. | MATERIAL | GROOVE<br>DETAILS | TEETH/<br>TANGS | SIZE MM   |       |   | SIZE INCH |   |     |       |   |       |   |       |
|------------------------|-----------------|----------|-------------------|-----------------|-----------|-------|---|-----------|---|-----|-------|---|-------|---|-------|
| 4720765                | FM3091          | BRONZE   | RAD/WAG           | 76              | EXT TH    | 164.0 | x | 99.3      | x | 2.0 | 6.46  | x | 3.91  | x | 0.079 |
| 4.720.768-3            | FM5304MP        | STEEL    | END PLATE         | 45              | INT TH    | 155.0 | x | 92.7      | x | 9.0 | 6.1   | x | 3.5   | x | 0.354 |
| 4720768                | FM5304MP        | STEEL    | END PLATE         | 45              | INT TH    | 155.0 | x | 92.7      | x | 9.0 | 6.1   | x | 3.5   | x | 0.354 |
| 4.720.856-6            | FM3787          | BRONZE   | WAFFLE            | 48              | EXT TH    | 202.0 | x | 133.3     | x | 2.7 | 7.95  | x | 5.25  | x | 0.106 |
| 4720856                | FM3787          | BRONZE   | WAFFLE            | 48              | EXT TH    | 202.0 | x | 133.3     | x | 2.7 | 7.95  | x | 5.25  | x | 0.106 |
| 4.720.857-4            | FM3790MP        | STEEL    | -----             | 36              | INT TH    | 193.0 | x | 125.0     | x | 2.8 | 7.6   | x | 4.92  | x | 0.11  |
| 4720857                | FM3790MP        | STEEL    | -----             | 36              | INT TH    | 193.0 | x | 125.0     | x | 2.8 | 7.6   | x | 4.92  | x | 0.11  |
| 4.720.944              | FM1711          | BRONZE   | SPR/WAG           | 23              | INT TH    | 224.0 | x | 70.1      | x | 4.9 | 8.82  | x | 2.76  | x | 0.193 |
| 4720944                | FM1711          | BRONZE   | SPR/WAG           | 23              | INT TH    | 224.0 | x | 70.1      | x | 4.9 | 8.82  | x | 2.76  | x | 0.193 |
| 4.720.945              | FM1204MP        | STEEL    | -----             | 1               | EXT LG    | 228.6 | x | 127.0     | x | 2.7 | 9.0   | x | 5.0   | x | 0.106 |
| 4720945                | FM1204MP        | STEEL    | -----             | 1               | EXT LG    | 228.6 | x | 127.0     | x | 2.7 | 9.0   | x | 5.0   | x | 0.106 |
| 4.780.005              | FM1361          | BRONZE   | SUNBURST          | 45              | INT TH    | 133.1 | x | 92.7      | x | 1.6 | 5.24  | x | 3.65  | x | 0.063 |
| 4780005                | FM1361          | BRONZE   | SUNBURST          | 45              | INT TH    | 133.1 | x | 92.7      | x | 1.6 | 5.24  | x | 3.65  | x | 0.063 |
| 4.786.524              | FM2065          | PAPER    | WAFFLE            | 45              | INT TH    | 133.1 | x | 92.7      | x | 1.6 | 5.24  | x | 3.65  | x | 0.063 |
| 4786524                | FM2065          | PAPER    | WAFFLE            | 45              | INT TH    | 133.1 | x | 92.7      | x | 1.6 | 5.24  | x | 3.65  | x | 0.063 |
| 4.786.525              | FM1361          | BRONZE   | SUNBURST          | 45              | INT TH    | 133.1 | x | 92.7      | x | 1.6 | 5.24  | x | 3.65  | x | 0.063 |
| 4786525                | FM1361          | BRONZE   | SUNBURST          | 45              | INT TH    | 133.1 | x | 92.7      | x | 1.6 | 5.24  | x | 3.65  | x | 0.063 |
| 4.871.796-1            | FM2065          | PAPER    | WAFFLE            | 45              | INT TH    | 133.1 | x | 92.7      | x | 1.6 | 5.24  | x | 3.65  | x | 0.063 |
| 4871796                | FM2065          | PAPER    | WAFFLE            | 45              | INT TH    | 133.1 | x | 92.7      | x | 1.6 | 5.24  | x | 3.65  | x | 0.063 |
| 4.871.966              | FM3652MP        | STEEL    | -----             | 54              | EXT LG    | 139.2 | x | 98.6      | x | 1.5 | 5.48  | x | 3.88  | x | 0.059 |
| 4871966                | FM3652MP        | STEEL    | -----             | 54              | EXT LG    | 139.2 | x | 98.6      | x | 1.5 | 5.48  | x | 3.88  | x | 0.059 |
| 4.871.979              | FM2065          | PAPER    | WAFFLE            | 45              | INT TH    | 133.1 | x | 92.7      | x | 1.6 | 5.24  | x | 3.65  | x | 0.063 |
| 4871979                | FM2065          | PAPER    | WAFFLE            | 45              | INT TH    | 133.1 | x | 92.7      | x | 1.6 | 5.24  | x | 3.65  | x | 0.063 |
| 4.873.015-4            | FM3091          | BRONZE   | RAD/WAG           | 76              | EXT TH    | 164.0 | x | 99.3      | x | 2.0 | 6.46  | x | 3.91  | x | 0.079 |
| 4873015                | FM3091          | BRONZE   | RAD/WAG           | 76              | EXT TH    | 164.0 | x | 99.3      | x | 2.0 | 6.46  | x | 3.91  | x | 0.079 |
| 4.873.015-4            | FM4401          | BRONZE   | RADIAL            | 76              | EXT TH    | 164.0 | x | 99.3      | x | 2.0 | 6.46  | x | 3.91  | x | 0.079 |
| 4873015                | FM4401          | BRONZE   | RADIAL            | 76              | EXT TH    | 164.0 | x | 99.3      | x | 2.0 | 6.46  | x | 3.91  | x | 0.079 |
| 4.873.042-8            | FM1361          | BRONZE   | SUNBURST          | 45              | INT TH    | 133.1 | x | 92.7      | x | 1.6 | 5.24  | x | 3.65  | x | 0.063 |
| 4873042                | FM1361          | BRONZE   | SUNBURST          | 45              | INT TH    | 133.1 | x | 92.7      | x | 1.6 | 5.24  | x | 3.65  | x | 0.063 |
| 4.873.042-8            | FM3879          | BRONZE   | 120 RADIAL        | 45              | INT TH    | 133.1 | x | 92.7      | x | 1.6 | 5.24  | x | 3.65  | x | 0.063 |
| 4873042                | FM3879          | BRONZE   | 120 RADIAL        | 45              | INT TH    | 133.1 | x | 92.7      | x | 1.6 | 5.24  | x | 3.65  | x | 0.063 |
| 4.873.043-6            | FM2065          | PAPER    | WAFFLE            | 45              | INT TH    | 133.1 | x | 92.7      | x | 1.6 | 5.24  | x | 3.65  | x | 0.063 |
| 4873043                | FM2065          | PAPER    | WAFFLE            | 45              | INT TH    | 133.1 | x | 92.7      | x | 1.6 | 5.24  | x | 3.65  | x | 0.063 |
| 6.201.832              | FM3024MP        | STEEL    | -----             | 12              | EXT LG    | 317.7 | x | 268.0     | x | 3.0 | 12.51 | x | 10.55 | x | 0.118 |
| 6201832                | FM3024MP        | STEEL    | -----             | 12              | EXT LG    | 317.7 | x | 268.0     | x | 3.0 | 12.51 | x | 10.55 | x | 0.118 |
| 6.213.302              | FM3021          | BRONZE   | SUNBURST          | 87              | INT TH    | 306.0 | x | 258.0     | x | 3.0 | 12.05 | x | 10.16 | x | 0.118 |
| 6213302                | FM3021          | BRONZE   | SUNBURST          | 87              | INT TH    | 306.0 | x | 258.0     | x | 3.0 | 12.05 | x | 10.16 | x | 0.118 |
| 6.643.999-03           | FM3021          | BRONZE   | SUNBURST          | 87              | INT TH    | 306.0 | x | 258.0     | x | 3.0 | 12.05 | x | 10.16 | x | 0.118 |
| 6643999                | FM3021          | BRONZE   | SUNBURST          | 87              | INT TH    | 306.0 | x | 258.0     | x | 3.0 | 12.05 | x | 10.16 | x | 0.118 |
| 6.645.112              | FM3021          | BRONZE   | SUNBURST          | 87              | INT TH    | 306.0 | x | 258.0     | x | 3.0 | 12.05 | x | 10.16 | x | 0.118 |
| 6645112                | FM3021          | BRONZE   | SUNBURST          | 87              | INT TH    | 306.0 | x | 258.0     | x | 3.0 | 12.05 | x | 10.16 | x | 0.118 |
| 8550570                | FM3963          | PAPER    | 2 PASS            | 10              | EXT LG    | 177.0 | x | 126.0     | x | 3.0 | 6.97  | x | 4.97  | x | 0.117 |
| 11035240               | FM6755          | PAPER    | WAFFLE            | 36              | INT TH    | 269.0 | x | 60.5      | x | 8.6 | 10.59 | x | 2.38  | x | 0.339 |
| 11035574               | FM5157          | PAPER    | WAFFLE            | 54              | INT TH    | 420.0 | x | 132.1     | x | 8.9 | 16.54 | x | 5.2   | x | 0.35  |
| 11036733-1             | FM3764MP        | STEEL    | -----             | 30              | (32)EX TH | 315.0 | x | 247.0     | x | 3.0 | 12.4  | x | 9.72  | x | 0.118 |
| 11036734-9             | FM3760MP        | STEEL    | -----             | 48              | EXT TH    | 232.0 | x | 171.0     | x | 3.0 | 9.13  | x | 6.73  | x | 0.118 |
| 11037030-1             | FM3219          | PAPER    | 2 PASS            | 23              | INT TH    | 224.0 | x | 70.1      | x | 4.8 | 8.82  | x | 2.76  | x | 0.19  |
| 11037031-9             | FM3222MP        | STEEL    | -----             | 1               | EXT LG    | 228.6 | x | 127.0     | x | 2.7 | 9.0   | x | 5.0   | x | 0.106 |

| REPLACES<br>OEM PT.NO. | FMC<br>PART NO. | MATERIAL                                     | GROOVE<br>DETAILS | TEETH/<br>TANGS | SIZE MM | SIZE INCH                                 |  |
|------------------------|-----------------|--|-------------------|-----------------|---------|---|--|
| 11037145               | FM5304MP        | STEEL  | END PLATE         | 45              | INT TH  | 155.0 x 92.7 x 9.0 6.1 x 3.5 x 0.354      |  |
| 11037156-4             | FM3652MP        | STEEL  | -----             | 54              | EXT LG  | 139.2 x 98.6 x 1.5 5.48 x 3.88 x 0.059    |  |
| 11037196-0             | FM3091          | BRONZE                                       | RAD/WAG           | 76              | EXT TH  | 164.0 x 99.3 x 2.0 6.46 x 3.91 x 0.079    |  |
| 11037196-0             | FM4401          | BRONZE                                       | RADIAL            | 76              | EXT TH  | 164.0 x 99.3 x 2.0 6.46 x 3.91 x 0.079    |  |
| 11037468-3             | FM3755          | PAPER  | 2 PASS            | 54              | INT TH  | 328.0 x 265.0 x 3.7 12.91 x 10.43 x 0.146 |  |
| 11037469-1             | FM3501          | PAPER  | 2 PASS            | 65              | INT TH  | 218.0 x 162.0 x 2.8 8.58 x 6.38 x 0.11    |  |
| 11037474-1             | FM3751          | PAPER  | 2 PASS            | 96              | INT TH  | 294.0 x 240.0 x 3.8 11.57 x 9.45 x 0.15   |  |
| 11037475-8             | FM3753          | PAPER  | 2 PASS            | 50              | INT TH  | 315.0 x 246.5 x 3.7 12.63 x 9.7 x 0.146   |  |
| 11037577               | FM6039          | PAPER  | 2 PASS            | 29              | INT TH  | 224.0 x 78.0 x 4.8 8.82 x 3.07 x 0.189    |  |
| 11037661               | FM6407KIT       | KIT  |                   |                 |         |   |  |
| 11037662               | FM6409KIT       | KIT  |                   |                 |         |   |  |
| 11037663               | FM6411KIT       | KIT  |                   |                 |         |   |  |
| 11037664               | FM6413KIT       | KIT  |                   |                 |         |   |  |
| 11037828               | FM5332MP        | STEEL  | END PLATE         | 45              | INT TH  | 155.0 x 92.7 x 9.8 6.1 x 3.5 x 0.386      |  |
| 11038189               | FM3755          | PAPER  | 2 PASS            | 54              | INT TH  | 328.0 x 265.0 x 3.7 12.91 x 10.43 x 0.146 |  |
| 11038191               | FM3501          | PAPER  | 2 PASS            | 65              | INT TH  | 218.0 x 162.0 x 2.8 8.58 x 6.38 x 0.11    |  |
| 11038192               | FM3751          | PAPER  | 2 PASS            | 96              | INT TH  | 294.0 x 240.0 x 3.8 11.57 x 9.45 x 0.15   |  |
| 11038193               | FM3753          | PAPER  | 2 PASS            | 50              | INT TH  | 315.0 x 246.5 x 3.7 12.4 x 9.7 x 0.146    |  |
| 11038721               | FM3501          | PAPER  | 2 PASS            | 65              | INT TH  | 218.0 x 162.0 x 2.8 8.58 x 6.38 x 0.11    |  |
| 11038722               | FM3751          | PAPER  | 2 PASS            | 96              | INT TH  | 294.0 x 240.0 x 3.8 11.57 x 9.45 x 0.15   |  |
| 11038723               | FM3753          | PAPER  | 2 PASS            | 50              | INT TH  | 315.0 x 246.5 x 3.7 12.4 x 9.7 x 0.146    |  |
| 11038724               | FM3755          | PAPER  | 2 PASS            | 54              | INT TH  | 328.0 x 265.0 x 3.7 12.91 x 10.43 x 0.146 |  |
| 11038798               | FM3755          | PAPER  | 2 PASS            | 54              | INT TH  | 328.0 x 265.0 x 3.7 12.91 x 10.43 x 0.146 |  |
| 11102271               | FM4473          | PAPER/BRZ                                    | WAFFLE            | 36              | INT TH  | 419.0 x 100.0 x 9.5 16.5 x 3.94 x 0.374   |  |
| 11102319               | FM4473          | PAPER/BRZ                                    | WAFFLE            | 36              | INT TH  | 419.0 x 100.0 x 9.5 16.5 x 3.94 x 0.374   |  |
| 11102321               | FM3885          | PAPER/BRZ                                    | WAFFLE            | 36              | INT TH  | 360.0 x 100.0 x 9.5 14.17 x 3.94 x 0.374  |  |
| 11102322               | FM5417          | CARBON PA                                    | WAFFLE            | 36              | INT TH  | 269.0 x 65.0 x 9.5 10.59 x 2.56 x 0.374   |  |
| 11103170               | FM5417          | CARBON PA                                    | WAFFLE            | 36              | INT TH  | 269.0 x 65.0 x 9.5 10.59 x 2.56 x 0.374   |  |
| 11103171               | FM3885          | PAPER/BRZ                                    | WAFFLE            | 36              | INT TH  | 360.0 x 100.0 x 9.5 14.17 x 3.94 x 0.374  |  |
| ALTERNATIVE            | FM7121          | CARBON PA                                    | WAFFLE            | 36              | INT TH  | 360.0 x 100.0 x 9.5 14.17 x 3.94 x 0.374  |  |
| 11103172               | FM4473          | PAPER/BRZ                                    | WAFFLE            | 36              | INT TH  | 419.0 x 100.0 x 9.5 16.5 x 3.94 x 0.374   |  |
| ALTERNATIVE            | FM7123          | CARBON PA                                    | WAFFLE            | 36              | INT TH  | 419.0 x 100.0 x 9.5 16.5 x 3.94 x 0.374   |  |
| 11103173               | FM6879          | CARBON PA                                    | WAFFLE            | 18              | INT TH  | 460.0 x 97.0 x 9.5 18.11 x 3.82 x 0.374   |  |
| 11143287               | FM7772MP        | STEEL  | -----             | 42              | EXT TH  | 471.6 x 322.3 x 5.0 18.57 x 12.69 x 0.197 |  |
| 11143290               | FM7769          | CARBON PA                                    | 3 PASS            | 61              | INT TH  | 456.6 x 300.5 x 4.4 17.98 x 11.83 x 0.171 |  |
| 11143365               | FM7773          | CORK   | -----             | 42              | EXT TH  | 471.6 x 322.5 x 6.9 18.57 x 12.7 x 0.272  |  |
| 11144415               | FM6447KIT       | KIT  |                   |                 |         |   |  |
| 11144441               | FM8210-9.05     | END PLATE                                    | -----             | 36              | INT TH  | 192.7 x 124.8 x 9.1 7.59 x 4.91 x 0.356   |  |
| 11144442               | FM8210-9.75     | END PLATE                                    | -----             | 36              | INT TH  | 192.7 x 124.8 x 9.8 7.59 x 4.91 x 0.384   |  |
| 11144443               | FM8210-10.55    | END PLATE                                    | -----             | 36              | INT TH  | 192.7 x 124.8 x 10.6 7.59 x 4.91 x 0.415  |  |
| 11144486               | FM5443KIT       | 12 x FM5151 + 10 x FM5154-1.6 + 2 x FM5154MP |                   |                 |         |   |  |
| 11144487               | FM5445KIT       | 7 x FM5151 + 6 x FM5154-1.6 + 1 x FM5154MP   |                   |                 |         |   |  |
| 11144604               | FM6489KIT       |  |                   |                 |         |   |  |
| 11144606               | FM5447KIT       | 9 x FM5151 + 8 x FM5154-1.6 + 1 x FM5154MP   |                   |                 |         |   |  |
| PART OF KIT            | FM5151          | PAPER  | WAFFLE            | 54              | EXT TH  | 139.2 x 98.6 x 1.6 5.48 x 3.88 x 0.063    |  |
| PART OF KIT            | FM5154MP        | STEEL  | -----             | 45              | INT TH  | 133.1 x 92.7 x 1.8 5.24 x 3.65 x 0.071    |  |
| PART OF KIT            | FM5154-1.6      | STEEL  | -----             | 45              | INT TH  | 133.1 x 92.7 x 1.6 5.24 x 3.65 x 0.063    |  |



| REPLACES<br>OEM PT.NO.  | FMC<br>PART NO. | MATERIAL  | GROOVE<br>DETAILS | TEETH/<br>TANGS | SIZE MM   | SIZE INCH                                  |
|---|-----------------|-----------|-------------------|-----------------|-----------|--|
| 11144991  | FM6875KIT       | KIT       |                   |                 |           |  |
| 11144992  | FM6877KIT       | KIT       |                   |                 |           |  |
| 11145196  | FM6491KIT       | KIT       |                   |                 |           |  |
| 11145206  | FM6469KIT       | KIT       |                   |                 |           |  |
| 11145597  | FM3758MP        | STEEL     | -----             | 48              | EXT TH    | 232.0 x 171.0 x 2.5 9.13 x 6.73 x 0.098    |
| 11145598  | FM3760MP        | STEEL     | -----             | 48              | EXT TH    | 232.0 x 171.0 x 3.0 9.13 x 6.73 x 0.118    |
| 11418427  | FM3758-2.4      | STEEL     | -----             | 48              | EXT TH    | 232.0 x 171.0 x 2.4 9.13 x 6.73 x 0.094    |
| 11418428  | FM3760-2.9      | STEEL     | -----             | 48              | EXT TH    | 232.0 x 171.0 x 2.9 9.13 x 6.73 x 0.114    |
| 11418432  | FM8891KIT       | KIT       |                   |                 |           |  |
| 11418433  | FM8941KIT       | KIT       |                   |                 |           |  |
| 11418439  | FM8943KIT       | KIT       |                   |                 |           |  |
| 11418440  | FM8945KIT       | KIT       |                   |                 |           |  |
| 11418447  | FM7703KIT       | KIT       |                   |                 |           |  |
| 11418448  | FM7705KIT       | KIT       |                   |                 |           |  |
| 11418676  | FM7363KIT       | KIT       |                   |                 |           |  |
| 11418677  | FM7365KIT       | KIT       |                   |                 |           |  |
| 11419059  | FM9107KIT       | KIT       |                   |                 |           |  |
| 11700825  | FM1779          | GRAPHITE  | SUNBURST          | 34              | (38)IN TH | 456.7 x 313.7 x 7.8 17.98 x 12.35 x 0.308  |
| 11700826  | FM3292MP        | STEEL     | -----             | 30              | (55)EX TH | 474.0 x 338.6 x 4.7 18.66 x 13.33 x 0.185  |
| 11701244  | FM4473KIT       | PAPER/BRZ | WAFFLE            | 36              | INT TH    | 419.0 x 100.0 x 9.5 16.5 x 3.94 x 0.374    |
| 11702448  | FM3885KIT       | PAPER/BRZ | WAFFLE            | 36              | INT TH    | 360.0 x 100.0 x 9.5 14.17 x 3.94 x 0.374   |
| 11702571  | FM4473KIT       | PAPER/BRZ | WAFFLE            | 36              | INT TH    | 419.0 x 100.0 x 9.5 16.5 x 3.94 x 0.374    |
| 11703493-4  | FM4473KIT       | PAPER/BRZ | WAFFLE            | 36              | INT TH    | 419.0 x 100.0 x 9.5 16.5 x 3.94 x 0.374    |
| ALTERNATIVE   | FM7123KIT       | CARBON PA | WAFFLE            | 36              | INT TH    | 419.0 x 100.0 x 9.5 16.5 x 3.94 x 0.374    |
| 11703544-4  | FM3885KIT       | PAPER/BRZ | WAFFLE            | 36              | INT TH    | 360.0 x 100.0 x 9.5 14.17 x 3.94 x 0.374   |
| THIS KIT INCLUDES THE PARTS TO REPLACE THE OIL THROWER AND THE GAUGE ONLY |                 |           |                   |                 |           |  |
| ALTERNATIVE   | FM7121KIT       | CARBON PA | WAFFLE            | 36              | INT TH    | 360.0 x 100.0 x 9.5 14.17 x 3.94 x 0.374   |
| THIS KIT INCLUDES THE PARTS TO REPLACE THE OIL THROWER AND THE GAUGE ONLY |                 |           |                   |                 |           |  |
| 11703590  | FM5417KIT       | CARBON PA | WAFFLE            | 36              | INT TH    | 269.0 x 65.0 x 9.5 10.59 x 2.56 x 0.374    |
| 11703615  | FM1216MP        | STEEL     | -----             | 60              | EXT TH    | 154.2 x 113.8 x 1.8 6.07 x 4.48 x 0.07     |
| 11703652  | FM1278MP        | STEEL     | -----             | 14              | (20)EX TH | 218.9 x 158.8 x 2.7 8.62 x 6.25 x 0.106    |
| 11703761  | FM6879KIT       | CARBON PA |                   |                 |           |  |
| 11703855  | FM1960MP        | STEEL     | -----             | 35              | INT TH    | 228.1 x 159.0 x 2.7 8.98 x 6.26 x 0.105    |
| 11703856  | FM1218MP        | STEEL     | -----             | 16              | (24)EX TH | 257.2 x 190.5 x 2.7 10.13 x 7.5 x 0.106    |
| 11704644  | FM1816MP        | STEEL     | DISHED            | 32              | (42)EX TH | 184.2 x 92.7 x 2.6 7.25 x 3.65 x 0.102     |
| 11704645  | FM0647          | BRONZE    | SUNBURST          | 19              | INT TH    | 165.1 x 74.2 x 4.0 6.5 x 2.92 x 0.156      |
| 11704646  | FM1191          | GRAPHITE  | SUNBURST          | 60              | INT TH    | 195.1 x 145.0 x 4.0 7.68 x 5.71 x 0.156    |
| 11704647  | FM1193          | GRAPHITE  | SUNBURST          | 72              | INT TH    | 233.4 x 175.5 x 4.0 9.19 x 6.91 x 0.156    |
| 11704787  | FM1497GK        | NYLON     | 16 HOLES          | 96              | INT TH    | 357.9 x 298.5 x 20.8 14.09 x 11.75 x 0.819 |
| 11704788  | FM3299GK        | NYLON     | 24 HOLES          | 90              | INT TH    | 451.1 x 374.9 x 28.0 17.76 x 14.76 x 1.102 |
| 11704882  | FM1324MP        | STEEL     | -----             | 54              | EXT TH    | 139.2 x 98.6 x 1.8 5.48 x 3.88 x 0.07      |
| 11705005  | FM4844MP        | STEEL     | -----             | 67              | (70)EX TH | 191.0 x 130.0 x 2.0 7.52 x 5.12 x 0.079    |
| 11705006  | FM3948MP        | STEEL     | -----             | 67              | (70)EX TH | 191.0 x 130.0 x 2.5 7.52 x 5.12 x 0.098    |
| 11705007  | FM3946MP        | STEEL     | -----             | 67              | (70)EX TH | 191.0 x 130.0 x 3.0 7.52 x 5.12 x 0.118    |
| 11705008  | FM3575          | PAPER     | 3 PASS            | 35              | INT TH    | 179.0 x 103.0 x 3.5 7.05 x 4.05 x 0.138    |
| 11705168  | FM4650MP        | STEEL     | -----             | 24              | EXT TH    | 108.2 x 76.2 x 1.2 4.26 x 3 x 0.045        |
| 11705172  | FM4647          | BRONZE    | SPR/RAD           | 34              | INT TH    | 100.0 x 68.2 x 1.6 3.94 x 2.69 x 0.061     |
| 11705190  | FM7038MP        | STEEL     | HARD/BLACK        | 64              | EXT TH    | 196.4 x 140.0 x 2.9 7.73 x 5.51 x 0.114    |

| REPLACES<br>OEM PT.NO. | FMC<br>PART NO. | MATERIAL  | GROOVE<br>DETAILS | TEETH/<br>TANGS | SIZE MM   | SIZE INCH                                 |
|------------------------|-----------------|-----------|-------------------|-----------------|-----------|---|
| 11706058               | FM6198MP        | STEEL     | -----             | 7               | (28)EX TH | 314.2 x 227.3 x 2.0 12.37 x 8.95 x 0.079  |
| 11706196               | FM3967          | PAPER     | RADIAL            | 46              | INT TH    | 278.0 x 228.0 x 2.7 10.84 x 8.98 x 0.106  |
| 11707294               | FM4000MP        | STEEL     | -----             | 12              | EXT LG    | 360.0 x 301.0 x 3.5 14.16 x 11.85 x 0.137 |
| 11707321               | FM3889          | BRONZE    | SPR/RAD           | 48              | INT TH    | 278.0 x 238.0 x 3.0 10.94 x 9.37 x 0.117  |
| 11708345               | FM3963          | PAPER     | 2 PASS            | 10              | EXT LG    | 177.0 x 126.0 x 3.0 6.97 x 4.97 x 0.117   |
| 11708593               | FM3967          | PAPER     | RADIAL            | 46              | INT TH    | 278.0 x 228.0 x 2.7 10.84 x 8.98 x 0.106  |
| 11708805               | FM3965          | PAPER     | RADIAL            | 43              | INT TH    | 257.0 x 212.0 x 3.0 10.11 x 8.34 x 0.117  |
| 11709086               | FM2828MP        | STEEL     | -----             | 6               | EXT LG    | 151.0 x 98.0 x 2.5 5.94 x 3.86 x 0.098    |
| 11709087               | FM2825          | BRONZE    | SUNBURST          | 45              | INT TH    | 133.0 x 93.0 x 1.8 5.24 x 3.66 x 0.069    |
| 11709332               | FM7337          | PAPER     | 2 PASS            | 36              | INT TH    | 223.0 x 71.0 x 4.9 8.78 x 2.8 x 0.191     |
| 11709333               | FM3912MP        | END PLATE | -----             | 64              | EXT TH    | 230.0 x 152.5 x 5.0 9.06 x 6 x 0.197      |
| 11709335               | FM3910MP        | END PLATE | -----             | 64              | EXT TH    | 230.0 x 151.0 x 9.0 9.06 x 5.94 x 0.354   |
| 11711970               | FM2737          | GRAPHITE  | SUNBURST          | 60              | INT TH    | 212.6 x 145.0 x 4.0 8.37 x 5.71 x 0.156   |
| 11712158               | FM2733          | GRAPHITE  | SUNBURST          | 72              | INT TH    | 244.2 x 175.5 x 4.0 9.62 x 6.91 x 0.156   |
| 11712159               | OBSOLETE        | GRAPHITE  | SUNBURST          | 68              | INT TH    | 327.0 x 236.1 x 4.8 12.88 x 9.3 x 0.188   |
| 11712160               | FM2725          | GRAPHITE  | SUNBURST          | 60              | INT TH    | 292.1 x 207.0 x 4.0 11.5 x 8.15 x 0.156   |
| 11712162               | FM1193          | GRAPHITE  | SUNBURST          | 72              | INT TH    | 233.4 x 175.5 x 4.0 9.19 x 6.91 x 0.157   |
| 11712514               | FM3967          | PAPER     | RADIAL            | 46              | INT TH    | 278.0 x 228.0 x 2.7 10.84 x 8.98 x 0.106  |
| 11712599               | FM1782MP        | STEEL     | -----             | 9               | EXT LG    | 477.8 x 338.6 x 4.7 18.81 x 13.33 x 0.185 |
| 11712763               | FM3963          | PAPER     | 2 PASS            | 10              | EXT LG    | 177.0 x 126.0 x 3.0 6.97 x 4.97 x 0.117   |
| 11712765               | FM1779          | GRAPHITE  | SUNBURST          | 34              | (38)IN TH | 456.7 x 313.7 x 7.8 17.98 x 12.35 x 0.308 |
| 11712953               | FM5779KIT       | KIT       |                   |                 |           |   |
| 11712958               | FM5773KIT       | KIT       |                   |                 |           |   |
| 11712966               | FM5775KIT       | KIT       |                   |                 |           |   |
| 11712971               | FM5777KIT       | KIT       |                   |                 |           |   |
| 11712997               | FM5781KIT       | KIT       |                   |                 |           |   |
| 11713163               | FM1782MP        | STEEL     | -----             | 9               | EXT LG    | 477.8 x 338.6 x 4.7 18.81 x 13.33 x 0.185 |
| 11716579               | FM6587          | PAPER     | WAFFLE            | 15              | INT TH    | 289.0 x 43.0 x 6.7 11.38 x 1.69 x 0.262   |
| 11716580               | FM6590MP        | STEEL     | -----             | 3               | EXT SL    | 335.5 x 188.4 x 5.0 13.21 x 7.42 x 0.197  |
| 11716581               | FM6592MP        | STEEL     | -----             | 3               | EXT SL    | 335.5 x 188.4 x 8.0 13.21 x 7.42 x 0.315  |
| 11988608               | FM3414MP        | END PLATE | -----             | 32              | (64)EX TH | 230.0 x 152.5 x 10.8 9.06 x 6.0 x 0.397   |
| 11988852               | FM4686MP        | STEEL     | -----             | 81              | EXT TH    | 243.6 x 152.1 x 2.5 9.59 x 5.99 x 0.098   |
| 11988853               | FM6120-3.0      | STEEL     | -----             | 81              | EXT TH    | 243.5 x 153.0 x 3.0 9.59 x 6.02 x 0.118   |
| 11988854               | FM6896MP        | STEEL     | -----             | 81              | EXT TH    | 243.6 x 152.1 x 2.0 9.59 x 5.99 x 0.079   |
| 11988855               | FM4089          | PAPER     | 3 PASS            | 48              | INT TH    | 232.7 x 142.0 x 4.0 9.16 x 5.59 x 0.157   |
| 11991091               | FM3998MP        | STEEL     | "M"               | 45              | EXT TH    | 281.0 x 221.0 x 3.0 11.05 x 8.7 x 0.118   |
| 11991092               | FM3965          | PAPER     | RADIAL            | 43              | INT TH    | 257.0 x 212.0 x 3.0 10.11 x 8.34 x 0.117  |
| 11991093               | FM3976MP        | STEEL     | -----             | 34              | (45)EX TH | 281.0 x 221.0 x 2.0 11.05 x 8.7 x 0.079   |
| 11991099               | FM3972MP        | STEEL     | -----             | 32              | INT TH    | 163.0 x 94.0 x 2.0 6.41 x 3.69 x 0.079    |
| 11991100               | FM3963          | PAPER     | 2 PASS            | 10              | EXT LG    | 177.0 x 126.0 x 3.0 6.97 x 4.97 x 0.117   |
| 11991116               | FM3992MP        | STEEL     | HOLES             | 24              | (32)EX TH | 306.0 x 237.0 x 3.0 12.03 x 9.3 x 0.118   |
| 11991117               | FM3967          | PAPER     | RADIAL            | 46              | INT TH    | 278.0 x 228.0 x 2.7 10.84 x 8.98 x 0.106  |
| 11991118               | FM3988MP        | STEEL     | HOLES             | 24              | (32)EX TH | 306.0 x 237.0 x 2.0 12.03 x 9.3 x 0.079   |
| 11991164               | FM3889          | BRONZE    | SPR/RAD           | 48              | INT TH    | 278.0 x 238.0 x 3.0 10.94 x 9.37 x 0.117  |
| 11991165               | FM3892MP        | STEEL     | 8 HOLES           | 24              | (32)EX TH | 306.0 x 247.0 x 2.0 12.03 x 9.72 x 0.079  |
| 11991282               | FM3969          | PAPER     | RADIAL            | 18              | INT TH    | 329.0 x 285.0 x 3.0 12.96 x 11.24 x 0.117 |
| 11991283               | FM3969          | PAPER     | RADIAL            | 18              | INT TH    | 329.0 x 285.0 x 3.0 12.96 x 11.24 x 0.117 |

| REPLACES<br>OEM PT.NO. | FMC<br>PART NO. | MATERIAL  | GROOVE<br>DETAILS | TEETH/<br>TANGS | SIZE MM   |       |   | SIZE INCH |   |      |       |   |       |   |       |
|------------------------|-----------------|-----------|-------------------|-----------------|-----------|-------|---|-----------|---|------|-------|---|-------|---|-------|
| 11992417               | FM1181          | GRAPHITE  | SUNBURST          | 62              | INT TH    | 319.0 | x | 259.1     | x | 3.8  | 12.56 | x | 10.2  | x | 0.148 |
| 11992887               | FM1324MP        | STEEL     | -----             | 54              | EXT TH    | 139.2 | x | 98.6      | x | 1.8  | 5.48  | x | 3.88  | x | 0.07  |
| 11992913               | FM1337OE        | BRONZE    | RADIAL            | 45              | INT TH    | 133.1 | x | 92.7      | x | 2.3  | 5.24  | x | 3.65  | x | 0.09  |
| 11992955-2             | FM3648MP        | END PLATE | STEPPED           | 54              | EXT TH    | 139.2 | x | 98.6      | x | 9.0  | 5.48  | x | 3.88  | x | 0.354 |
| 11992958               | FM1337OE        | BRONZE    | RADIAL            | 45              | INT TH    | 133.1 | x | 92.7      | x | 2.3  | 5.24  | x | 3.65  | x | 0.09  |
| 11993291               | FM3986MP        | STEEL     | -----             | 24              | (32)EX TH | 306.0 | x | 237.0     | x | 3.0  | 12.03 | x | 9.3   | x | 0.118 |
| 11993759               | FM1216MP        | STEEL     | -----             | 60              | EXT TH    | 154.2 | x | 113.8     | x | 1.8  | 6.07  | x | 4.48  | x | 0.07  |
| 11993773               | FM1307OE        | BRONZE    | RADIAL            | 52              | INT TH    | 148.6 | x | 107.7     | x | 2.6  | 5.85  | x | 4.24  | x | 0.102 |
| 11993812               | FM1305OE        | BRONZE    | RADIAL            | 52              | INT TH    | 148.6 | x | 107.7     | x | 2.6  | 5.85  | x | 4.24  | x | 0.102 |
| 11993839               | FM1375OE        | BRONZE    | RADIAL            | 45              | INT TH    | 133.1 | x | 92.7      | x | 2.4  | 5.24  | x | 3.65  | x | 0.093 |
| 11994241               | FM3021          | BRONZE    | SUNBURST          | 87              | INT TH    | 306.0 | x | 258.0     | x | 3.0  | 12.05 | x | 10.16 | x | 0.118 |
| 11997188               | FM3963          | PAPER     | 2 PASS            | 10              | EXT LG    | 177.0 | x | 126.0     | x | 3.0  | 6.97  | x | 4.97  | x | 0.117 |
| 11997445               | FM1782MP        | STEEL     | -----             | 9               | EXT LG    | 477.8 | x | 338.6     | x | 4.7  | 18.81 | x | 13.33 | x | 0.185 |
| 11997446               | FM1779          | GRAPHITE  | SUNBURST          | 34              | (38)IN TH | 456.7 | x | 313.7     | x | 7.8  | 17.98 | x | 12.35 | x | 0.308 |
| 11997615               | FM6566MP        | STEEL     | HARDENED          | 28              | INT TH    | 139.9 | x | 93.1      | x | 1.5  | 5.51  | x | 3.67  | x | 0.059 |
| 11997616               | FM4845          | BRONZE    | SPR/RAD           | 6               | EXT LG    | 157.0 | x | 102.0     | x | 2.4  | 6.18  | x | 4.02  | x | 0.094 |
| 11997643               | FM6567          | BRONZE    | WAFFLE            | 22              | INT TH    | 110.0 | x | 64.0      | x | 2.1  | 4.33  | x | 2.52  | x | 0.083 |
| 11997644               | FM6570MP        | STEEL     | HARDENED          | 6               | EXT LG    | 121.9 | x | 72.5      | x | 1.5  | 4.8   | x | 2.85  | x | 0.059 |
| 11998591               | FM3894MP        | STEEL     | 8 HOLES           | 24              | (32)EX TH | 306.0 | x | 247.0     | x | 2.5  | 12.03 | x | 9.72  | x | 0.098 |
| 11999371               | FM3963          | PAPER     | 2 PASS            | 10              | EXT LG    | 177.0 | x | 126.0     | x | 3.0  | 6.97  | x | 4.97  | x | 0.117 |
| 11999723-7             | FM3560MP        | STEEL     | -----             | 40              | EXT TH    | 260.0 | x | 191.0     | x | 2.6  | 10.24 | x | 7.52  | x | 0.1   |
| 11999724               | FM2733          | GRAPHITE  | SUNBURST          | 72              | INT TH    | 244.2 | x | 175.5     | x | 4.0  | 9.62  | x | 6.91  | x | 0.156 |
| 11999748               | FM6200MP        | STEEL     | -----             | 7               | (28)EX TH | 314.2 | x | 227.3     | x | 2.6  | 12.37 | x | 8.95  | x | 0.102 |
| 11999749-2             | FM2725          | GRAPHITE  | SUNBURST          | 60              | INT TH    | 292.1 | x | 207.0     | x | 4.0  | 11.5  | x | 8.15  | x | 0.156 |
| 11999977               | FM6755KIT       | PAPER     | WAFFLE            | 36              | INT TH    | 269.0 | x | 60.5      | x | 8.6  | 10.59 | x | 2.38  | x | 0.339 |
| 12743128               | FM8570MP        | STEEL     | HARDENED          | 8               | EXT LG    | 247.7 | x | 156.7     | x | 6.0  | 9.75  | x | 6.17  | x | 0.236 |
| 12743129               | FM8567          | BRONZE    | SPR/RAD           | 35              | INT TH    | 235.3 | x | 104.2     | x | 4.2  | 9.26  | x | 4.1   | x | 0.165 |
| 12968737               | FM1311          | GRAPHITE  | SUNBURST          | 73              | INT TH    | 371.3 | x | 303.0     | x | 5.2  | 14.62 | x | 11.93 | x | 0.205 |
| 12973349-9             | FM1726MP        | STEEL     | -----             | 12              | EXT LG    | 414.3 | x | 254.0     | x | 4.7  | 16.31 | x | 10    | x | 0.185 |
| 14012880-2             | FM4848MP        | STEEL     | SINEWAVED         | 3               | INT TH    | 123.0 | x | 72.2      | x | 1.5  | 4.84  | x | 2.84  | x | 0.059 |
| 14043070-3             | FM3933          | BRONZE    | SPR/RAD           | 6               | EXT LG    | 137.0 | x | 84.0      | x | 2.4  | 5.39  | x | 3.31  | x | 0.094 |
| 14506913               | FM6331          | PAPER     | 3 PASS            | 54              | (60)IN TH | 448.0 | x | 300.0     | x | 5.1  | 17.64 | x | 11.81 | x | 0.2   |
| 14506914               | FM6334MP        | STEEL     | -----             | 90              | EXT TH    | 462.0 | x | 326.0     | x | 4.9  | 18.19 | x | 12.83 | x | 0.193 |
| 14506915               | FM6336MP        | STEEL     | -----             |                 | RING      | 449.8 | x | 324.6     | x | 11.0 | 17.71 | x | 12.79 | x | 0.43  |
| 14520701               | FM2991          | PAPER     | 3 PASS            | 57              | INT TH    | 360.0 | x | 237.0     | x | 4.5  | 14.17 | x | 9.33  | x | 0.177 |
| 14529761               | FM7096MP        | STEEL     | -----             | 8               | EXT LG    | 163.7 | x | 139.0     | x | 1.7  | 6.44  | x | 5.47  | x | 0.067 |
| 14529762               | FM7093          | PAPER     | 2 PASS            | 43              | INT TH    | 155.0 | x | 129.4     | x | 2.0  | 6.1   | x | 5.09  | x | 0.079 |
| 14558958               | FM6715          | CARBON PA | WAFFLE            | 8               | EXT LG    | 262.7 | x | 155.0     | x | 4.5  | 10.34 | x | 6.1   | x | 0.177 |
| 14558960               | FM7132-2.0      | STEEL     | -----             | 36              | (48)IN TH | 236.0 | x | 144.2     | x | 2.0  | 9.29  | x | 5.68  | x | 0.079 |
| 14558961               | FM7132-3.0      | STEEL     | -----             | 36              | (48)IN TH | 236.0 | x | 144.2     | x | 3.0  | 9.29  | x | 5.68  | x | 0.118 |
| 14558962               | FM7132-2.5      | STEEL     | -----             | 36              | (48)IN TH | 236.0 | x | 144.2     | x | 2.5  | 9.29  | x | 5.68  | x | 0.098 |
| 14573807               | FM8974MP        | STEEL     | -----             | 12              | EXT LG    | 147.5 | x | 127.0     | x | 1.5  | 5.81  | x | 5.0   | x | 0.059 |
| 14573808               | FM8971          | ELASTOMER | RADIAL            | 42              | (48)IN TH | 143.0 | x | 115.0     | x | 3.5  | 5.63  | x | 4.53  | x | 0.138 |
| 15000093               | FM7593KIT       | KIT       |                   |                 |           |       |   |           |   |      |       |   |       |   |       |
| 15000108               | FM7595KIT       | KIT       |                   |                 |           |       |   |           |   |      |       |   |       |   |       |
| 15001697               | FM8221          | PAPER     | 2 PASS            | 96              | INT TH    | 294.0 | x | 240.0     | x | 3.8  | 11.57 | x | 9.45  | x | 0.15  |
| 15001702               | FM8219          | WAFFLE    | 2 PASS            | 65              | INT TH    | 218.0 | x | 162.0     | x | 2.8  | 8.58  | x | 6.38  | x | 0.11  |
| 15001703               | FM8223          | WAFFLE    | 2 PASS            | 50              | INT TH    | 315.0 | x | 246.5     | x | 3.7  | 12.4  | x | 9.7   | x | 0.146 |

| REPLACES<br>OEM PT.NO. | FMC<br>PART NO. | MATERIAL  | GROOVE<br>DETAILS | TEETH/<br>TANGS | SIZE MM     |       |   | SIZE INCH |   |      |       |   |       |   |       |
|------------------------|-----------------|-----------|-------------------|-----------------|-------------|-------|---|-----------|---|------|-------|---|-------|---|-------|
| 15001704               | FM8225          | PAPER     | 2 PASS            | 54              | INT TH      | 328.0 | x | 265.0     | x | 3.7  | 12.91 | x | 10.43 | x | 0.146 |
| 15010426               | FM7543          | CARBON PA | 4 PASS            | 36              | INT TH      | 413.4 | x | 100.3     | x | 10.5 | 16.28 | x | 3.95  | x | 0.413 |
| 15010615               | FM7751          | CARBON PA | 4 PASS            | 18              | INT TH      | 459.4 | x | 97.3      | x | 10.5 | 18.09 | x | 3.83  | x | 0.413 |
| 15011845               | FM7377          | CARBON PA | 4 PASS            | 36              | INT TH      | 353.0 | x | 100.3     | x | 10.5 | 13.9  | x | 3.95  | x | 0.413 |
| 15012446               | FM7345          | PAPER     | 3 PASS            | 68              | INT TH      | 540.0 | x | 330.0     | x | 5.1  | 21.26 | x | 12.99 | x | 0.2   |
| 15017192               | FM7363KIT       | KIT       |                   |                 |             |       |   |           |   |      |       |   |       |   |       |
| 15017294               | FM7365KIT       | KIT       |                   |                 |             |       |   |           |   |      |       |   |       |   |       |
| 15017386               | FM7595KIT       | KIT       |                   |                 |             |       |   |           |   |      |       |   |       |   |       |
| 15017373               | FM7593KIT       | KIT       |                   |                 |             |       |   |           |   |      |       |   |       |   |       |
| 15019425               | FM7350MP        | STEEL     | -----             | 112             | EXT TH      | 565.0 | x | 365.0     | x | 2.4  | 22.24 | x | 14.37 | x | 0.094 |
| 15023672               | FM7545          | CARBON PA | 4 PASS            | 36              | INT TH      | 265.4 | x | 65.4      | x | 9.6  | 10.45 | x | 2.57  | x | 0.378 |
| 15035796               | FM6407KIT       | KIT       |                   |                 |             |       |   |           |   |      |       |   |       |   |       |
| 15035797               | FM6409KIT       | KIT       |                   |                 |             |       |   |           |   |      |       |   |       |   |       |
| 15035798               | FM6411KIT       | KIT       |                   |                 |             |       |   |           |   |      |       |   |       |   |       |
| 15035799               | FM6413KIT       | KIT       |                   |                 |             |       |   |           |   |      |       |   |       |   |       |
| 15035800               | FM8547KIT       | KIT       |                   |                 |             |       |   |           |   |      |       |   |       |   |       |
| 15045122               | FM7703KIT       | KIT       |                   |                 |             |       |   |           |   |      |       |   |       |   |       |
| 15045125               | FM7705KIT       | KIT       |                   |                 |             |       |   |           |   |      |       |   |       |   |       |
| 15047926               | FM9279          | CARBON PA | 4 PASS            | 40              | INT TH      | 414.0 | x | 112.1     | x | 10.5 | 16.3  | x | 4.41  | x | 0.413 |
| 15048053               | FM9107KIT       |           |                   |                 |             |       |   |           |   |      |       |   |       |   |       |
| 15053509               | FM9516MP        | STEEL     | -----             | 9               | EXT LG      | 416.4 | x | 297.5     | x | 5.0  | 16.39 | x | 11.71 | x | 0.197 |
| 15067329               | FM3760-2.9      | STEEL     | -----             | 48              | EXT TH      | 232.0 | x | 171.0     | x | 2.9  | 9.13  | x | 6.73  | x | 0.114 |
| 15067330               | FM3758-2.4      | STEEL     | -----             | 48              | EXT TH      | 232.0 | x | 171.0     | x | 2.4  | 9.13  | x | 6.73  | x | 0.94  |
| 15067331               | FM3762MP        | STEEL     | -----             | 30              | (32)EX TH   | 315.0 | x | 247.0     | x | 2.5  | 12.4  | x | 9.72  | x | 0.098 |
| 15067332               | FM3764MP        | STEEL     | -----             | 30              | (32)EX TH   | 315.0 | x | 247.0     | x | 3.0  | 12.4  | x | 9.72  | x | 0.118 |
| 15067333               | FM3766MP        | STEEL     | -----             | 31              | (32)EX TH   | 337.0 | x | 265.5     | x | 3.0  | 13.27 | x | 10.45 | x | 0.118 |
| 15067334               | FM3768MP        | STEEL     | -----             | 31              | (32)EX TH   | 337.0 | x | 265.5     | x | 3.5  | 13.27 | x | 10.45 | x | 0.138 |
| 15067335               | FM3774MP        | STEEL     | -----             | 31              | (32)EX TH   | 349.5 | x | 277.5     | x | 2.5  | 13.76 | x | 10.92 | x | 0.098 |
| 15067336               | FM3776MP        | STEEL     | -----             | 31              | (32)EX TH   | 349.5 | x | 277.5     | x | 3.0  | 13.76 | x | 10.92 | x | 0.118 |
| 15067337               | FM3770MP        | STEEL     | -----             | 31              | (32)EX TH   | 350.0 | x | 265.5     | x | 2.5  | 13.78 | x | 10.45 | x | 0.098 |
| 15067338               | FM3772MP        | STEEL     | -----             | 31              | (32)EX TH   | 350.0 | x | 265.5     | x | 3.0  | 13.78 | x | 10.45 | x | 0.118 |
| 15135374               | FM8943KIT       | KIT       |                   |                 |             |       |   |           |   |      |       |   |       |   |       |
| 15135400               | FM8945KIT       | KIT       |                   |                 |             |       |   |           |   |      |       |   |       |   |       |
| 15140158               | FM9365KIT       | KIT       |                   |                 |             |       |   |           |   |      |       |   |       |   |       |
| 15140186               | FM9371KIT       | KIT       |                   |                 |             |       |   |           |   |      |       |   |       |   |       |
| 15171124               | FM8693KIT       | KIT       |                   |                 |             |       |   |           |   |      |       |   |       |   |       |
| 15171133               | FM8695KIT       | KIT       |                   |                 |             |       |   |           |   |      |       |   |       |   |       |
| 15171276               | FM7593KIT       | KIT       |                   |                 |             |       |   |           |   |      |       |   |       |   |       |
| 15171280               | FM7595KIT       | KIT       |                   |                 |             |       |   |           |   |      |       |   |       |   |       |
| 15173187               | FM2739          | BRONZE    | SPR/WAG           | 97              | (105)INT TH | 400.8 | x | 309.6     | x | 5.3  | 15.78 | x | 12.19 | x | 0.21  |
| 15173243               | FM4737          | BRONZE    | SPR/WAG           | 75              | INT TH      | 280.0 | x | 221.0     | x | 5.0  | 11.02 | x | 8.7   | x | 0.196 |
| 15174006               | FM3284MP        | STEEL     | -----             | 130             | EXT TH      | 396.0 | x | 320.0     | x | 5.0  | 15.59 | x | 12.6  | x | 0.197 |
| 15174779               | FM7111          | CARBON    | WAFFLE            | 105             | INT TH      | 400.0 | x | 309.0     | x | 5.5  | 15.75 | x | 12.17 | x | 0.215 |
| 15175141               | FM7114MP        | STEEL     | -----             | 6               | EXT LG      | 466.9 | x | 323.4     | x | 3.2  | 18.38 | x | 12.73 | x | 0.126 |
| 15275520               | FM1779          | GRAPHITE  | SUNBURST          | 34              | (38)INT TH  | 456.7 | x | 313.7     | x | 7.8  | 17.98 | x | 12.35 | x | 0.308 |
| 15275521               | FM3292MP        | STEEL     | -----             | 30              | (55)EX TH   | 474.0 | x | 338.6     | x | 4.7  | 18.66 | x | 13.33 | x | 0.185 |
| 17205742               | FM8219          | WAFFLE    | 2 PASS            | 65              | INT TH      | 218.0 | x | 162.0     | x | 2.8  | 8.58  | x | 6.38  | x | 0.11  |

| REPLACES<br>OEM PT.NO. | FMC<br>PART NO. | MATERIAL   | GROOVE<br>DETAILS | TEETH/<br>TANGS | SIZE MM |       |   | SIZE INCH |   |     |       |   |       |   |       |
|------------------------|-----------------|------------|-------------------|-----------------|---------|-------|---|-----------|---|-----|-------|---|-------|---|-------|
| 17205750               | FM8223          | WAFFLE     | 2 PASS            | 50              | INT TH  | 315.0 | x | 246.5     | x | 3.7 | 12.4  | x | 9.7   | x | 0.146 |
| 17220884               | FM7363KIT       | KIT        |                   |                 |         |       |   |           |   |     |       |   |       |   |       |
| 17221276               | FM7365KIT       | KIT        |                   |                 |         |       |   |           |   |     |       |   |       |   |       |
| 17227869               | FM9513          | CARBON PA  | SHOCK             | 47              | INT TH  | 386.5 | x | 230.5     | x | 4.6 | 15.22 | s | 9.07  | x | 0.181 |
| 40188229               | FM4533          | MOLYBDENUM | SPR/RAD           | 44              | INT TH  | 191.3 | x | 94.2      | x | 4.1 | 7.53  | x | 3.71  | x | 0.161 |
| Torque Converter       | FM3777          | BRONZE     | SPIRAL            | 71              | INT TH  | 393.0 | x | 350.0     | x | 3.3 | 15.47 | x | 13.78 | x | 0.13  |
| Torque Converter       | FM3780MP        | STEEL      | -----             | 80              | EXT TH  | 402.0 | x | 363.0     | x | 2.0 | 15.83 | x | 14.29 | x | 0.079 |

| REPLACES<br>OEM PT.NO.          | FMC<br>PART NO. | MATERIAL | GROOVE<br>DETAILS | TEETH/<br>TANGS | SIZE MM   |       |   | SIZE INCH |   |     |       |   |       |   |       |
|---------------------------------|-----------------|----------|-------------------|-----------------|-----------|-------|---|-----------|---|-----|-------|---|-------|---|-------|
| <b>WABCO (ALSO SEE ALLISON)</b> |                 |          |                   |                 |           |       |   |           |   |     |       |   |       |   |       |
| A010124                         | FM1243          | GRAPHITE | SUNBURST          | 73              | INT TH    | 371.3 | x | 303.0     | x | 5.2 | 14.62 | x | 11.93 | x | 0.205 |
| A010437                         | FM1311          | GRAPHITE | SUNBURST          | 73              | INT TH    | 371.3 | x | 303.0     | x | 5.2 | 14.62 | x | 11.93 | x | 0.205 |
| A101438                         | FM1177          | GRAPHITE | SUNBURST          | 72              | INT TH    | 371.3 | x | 303.0     | x | 5.2 | 14.62 | x | 11.93 | x | 0.205 |
| TZ-5499                         | FM6451          | PAPER    | WAFFLE            | 87              | INT TH    | 368.3 | x | 181.0     | x | 5.3 | 14.5  | x | 7.13  | x | 0.21  |
| 122166-4                        | FM6451          | PAPER    | WAFFLE            | 87              | INT TH    | 368.3 | x | 181.0     | x | 5.3 | 14.5  | x | 7.13  | x | 0.21  |
| TBA                             | FM3218MP        | STEEL    | -----             | 89              | EXT TH    | 379.5 | x | 262.4     | x | 6.3 | 14.94 | x | 10.33 | x | 0.247 |
| 725193                          | FM3072MP        | STEEL    | -----             | 77              | INT TH    | 241.3 | x | 158.8     | x | 1.6 | 9.5   | x | 6.25  | x | 0.063 |
| 725224                          | FM1607G         | BRONZE   | SPR/RAD           | 119             | EXT TH    | 255.3 | x | 171.5     | x | 4.7 | 10.05 | x | 6.75  | x | 0.185 |
| <b>WAGNER / ATLAS COPCO</b>     |                 |          |                   |                 |           |       |   |           |   |     |       |   |       |   |       |
| 333867                          | FM1216MP        | STEEL    | -----             | 60              | EXT TH    | 154.2 | x | 113.8     | x | 1.8 | 6.07  | x | 4.48  | x | 0.07  |
| 334055                          | FM1195          | BRONZE   | SUNBURST          | 60              | INT TH    | 195.1 | x | 145.0     | x | 4.0 | 7.68  | x | 5.71  | x | 0.156 |
| 334282                          | FM1278MP        | STEEL    | -----             | 14              | (20)EX TH | 218.9 | x | 158.8     | x | 2.7 | 8.62  | x | 6.25  | x | 0.106 |
| 334290                          | FM1191          | GRAPHITE | SUNBURST          | 60              | INT TH    | 195.1 | x | 145.0     | x | 4.0 | 7.68  | x | 5.71  | x | 0.156 |
| 339613                          | FM1307OE        | BRONZE   | RADIAL            | 52              | INT TH    | 148.6 | x | 107.7     | x | 2.6 | 5.85  | x | 4.24  | x | 0.102 |
| 339692                          | FM1218MP        | STEEL    | -----             | 16              | (24)EX TH | 257.3 | x | 190.5     | x | 2.7 | 10.13 | x | 7.5   | x | 0.106 |
| 339705                          | FM1193          | GRAPHITE | SUNBURST          | 72              | INT TH    | 233.4 | x | 175.5     | x | 4.0 | 9.19  | x | 6.91  | x | 0.156 |
| 339706                          | FM2725          | GRAPHITE | SUNBURST          | 60              | INT TH    | 292.1 | x | 207.0     | x | 4.0 | 11.5  | x | 8.15  | x | 0.156 |
| 339711                          | FM1305OE        | BRONZE   | RADIAL            | 52              | INT TH    | 148.6 | x | 107.7     | x | 2.6 | 5.85  | x | 4.24  | x | 0.102 |
| 351568                          | FM1324MP        | STEEL    | -----             | 54              | EXT TH    | 139.2 | x | 98.6      | x | 1.8 | 5.48  | x | 3.88  | x | 0.07  |
| 353131                          | FM1326MP        | STEEL    | -----             | 72              | (90)EX TH | 462.0 | x | 350.0     | x | 3.5 | 18.19 | x | 13.78 | x | 0.138 |
| 353132                          | FM1259          | GRAPHITE | WAFFLE            | 54              | INT TH    | 450.3 | x | 269.5     | x | 5.5 | 17.73 | x | 10.61 | x | 0.216 |
| 353183                          | FM1337OE        | BRONZE   | RADIAL            | 45              | INT TH    | 133.1 | x | 92.7      | x | 2.3 | 5.24  | x | 3.65  | x | 0.09  |
| 355996                          | FM1375OE        | BRONZE   | RADIAL            | 45              | INT TH    | 133.1 | x | 92.7      | x | 2.4 | 5.24  | x | 3.65  | x | 0.093 |
| 361674                          | FM1723          | GRAPHITE | SUNBURST          | 36              | INT TH    | 394.5 | x | 222.3     | x | 6.2 | 15.53 | x | 8.75  | x | 0.245 |
| 361683                          | FM1726MP        | STEEL    | -----             | 12              | EXT TH    | 414.3 | x | 254.0     | x | 4.7 | 16.31 | x | 10    | x | 0.185 |
| 366161                          | FM1705          | BRONZE   | SPR/WAG           | 22              | INT TH    | 204.5 | x | 53.3      | x | 4.8 | 8.05  | x | 2.1   | x | 0.19  |
| 366162                          | FM1202MP        | STEEL    | -----             | 1               | EXT LG    | 209.3 | x | 114.3     | x | 2.7 | 8.24  | x | 4.5   | x | 0.106 |
| 367134                          | FM1381OE        | BRONZE   | RADIAL            | 52              | INT TH    | 148.6 | x | 107.7     | x | 2.9 | 5.85  | x | 4.24  | x | 0.114 |
| 368988                          | FM1381OE        | BRONZE   | RADIAL            | 52              | INT TH    | 148.6 | x | 107.7     | x | 2.9 | 5.85  | x | 4.24  | x | 0.114 |
| 369816                          | FM1723          | GRAPHITE | SUNBURST          | 36              | INT TH    | 394.5 | x | 222.3     | x | 6.2 | 15.53 | x | 8.75  | x | 0.245 |
| 370357                          | FM1782MP        | STEEL    | -----             | 9               | EXT LG    | 477.8 | x | 338.6     | x | 4.7 | 18.81 | x | 13.33 | x | 0.185 |
| 370358                          | FM1779          | GRAPHITE | SUNBURST          | 34              | (38)IN TH | 456.7 | x | 313.7     | x | 7.8 | 17.98 | x | 12.35 | x | 0.308 |
| 370558                          | FM1779          | GRAPHITE | SUNBURST          | 34              | (38)IN TH | 456.7 | x | 313.7     | x | 7.8 | 17.98 | x | 12.35 | x | 0.308 |
| 371749                          | FM1278MP        | STEEL    | -----             | 14              | (20)EX TH | 218.9 | x | 158.8     | x | 2.7 | 8.62  | x | 6.25  | x | 0.106 |
| 375391                          | FM1723          | GRAPHITE | SUNBURST          | 36              | INT TH    | 394.5 | x | 222.3     | x | 6.2 | 15.53 | x | 8.75  | x | 0.245 |
| 375392                          | FM1726MP        | STEEL    | -----             | 12              | EXT LG    | 414.3 | x | 254.0     | x | 4.7 | 16.31 | x | 10    | x | 0.185 |
| 378857                          | FM2687          | PAPER    | WAFFLE            | 48              | INT TH    | 400.0 | x | 240.0     | x | 4.7 | 15.74 | x | 9.46  | x | 0.184 |
| 378858                          | FM2690MP        | STEEL    | -----             | 12              | EXT LG    | 421.6 | x | 254.0     | x | 3.2 | 16.6  | x | 10.01 | x | 0.126 |
| 409040                          | FM2690MP        | STEEL    | -----             | 12              | EXT LG    | 421.6 | x | 254.0     | x | 3.2 | 16.6  | x | 10.01 | x | 0.126 |
| 409165                          | FM2687          | PAPER    | WAFFLE            | 48              | INT TH    | 400.0 | x | 240.0     | x | 4.7 | 15.74 | x | 9.46  | x | 0.184 |
| 4699801                         | FM1726MP        | STEEL    | -----             | 12              | EXT LG    | 414.3 | x | 254.0     | x | 4.7 | 16.31 | x | 10    | x | 0.185 |
| 4699943                         | FM3679          | GRAPHITE | SUNBURST          | 36              | INT TH    | 394.5 | x | 222.3     | x | 5.2 | 15.53 | x | 8.75  | x | 0.205 |
| 3222303269                      | FM5352MP        | STEEL    | -----             | 37              | EXT TH    | 75.5  | x | 57.2      | x | 1.1 | 2.97  | x | 2.25  | x | 0.042 |
| 3222303270                      | FM5349          | BRONZE   | WAFFLE            | 27              | INT TH    | 71.1  | x | 52.7      | x | 1.7 | 2.8   | x | 2.07  | x | 0.065 |
| 5112256028                      | FM2184MP        | STEEL    | -----             | 3               | EXT SL    | 201.7 | x | 129.5     | x | 2.7 | 7.94  | x | 5.1   | x | 0.106 |
| 5112300359                      | FM2341          | BRONZE   | SUNBURST          | 16              | INT TH    | 202.9 | x | 40.4      | x | 4.9 | 7.99  | x | 1.59  | x | 0.192 |

| REPLACES<br>OEM PT.NO. | FMC<br>PART NO. | MATERIAL  | GROOVE<br>DETAILS | TEETH/<br>TANGS | SIZE MM   | SIZE INCH           |                       |
|------------------------|-----------------|-----------|-------------------|-----------------|-----------|---------------------|-----------------------|
| 5112300360             | FM2344MP        | STEEL     | -----             | 6               | EXT LG    | 220.0 x 145.5 x 2.7 | 8.66 x 5.73 x 0.105   |
| 5112319149             | FM8116MP        | STEEL     | -----             | 3               | EXT LG    | 189.6 x 130.5 x 3.7 | 7.46 x 5.14 x 0.146   |
| 5112319158             | FM6977          | PAPER     | WAFFLE            | 54              | INT TH    | 178.0 x 105.6 x 3.8 | 7.01 x 4.16 x 0.148   |
| 5112319700             | FM6980MP        | STEEL     | -----             | 4               | EXT LG    | 199.7 x 114.0 x 3.7 | 7.86 x 4.49 x 0.146   |
| 5112320153             | FM6130MP        | STEEL     | -----             | 3               | EXT LG    | 268.0 x 176.0 x 4.5 | 10.55 x 6.93 x 0.177  |
| 5112320161             | FM6127          | PAPER     | WAFFLE            | 24              | INT TH    | 253.0 x 69.0 x 6.1  | 9.96 x 2.72 x 0.24    |
| 5112322938             | FM9392MP        | STEEL     | -----             | 3               | EXT LG    | 317.6 x 225.6 x 4.5 | 12.5 x 8.88 x 0.177   |
| 5533386700             | FM1216MP        | STEEL     | -----             | 60              | EXT TH    | 154.2 x 113.8 x 1.8 | 6.07 x 4.48 x 0.07    |
| 5533353900             | FM5239          | CARBON PA | 2 PASS            | 80              | INT TH    | 326.9 x 247.9 x 5.5 | 12.87 x 9.76 x 0.216  |
| 5533405500             | FM1195          | BRONZE    | SUNBURST          | 60              | INT TH    | 195.1 x 145.0 x 4.0 | 7.68 x 5.71 x 0.156   |
| 5533429000             | FM5227          | CARBON PA | 2 PASS            | 60              | INT TH    | 195.1 x 145.0 x 4.0 | 7.68 x 5.71 x 0.156   |
| 5533961300             | FM1307OE        | BRONZE    | RADIAL            | 52              | INT TH    | 148.6 x 107.7 x 2.6 | 5.85 x 4.24 x 0.102   |
| 5533969200             | FM1218MP        | STEEL     | -----             | 16              | (24)EX TH | 257.3 x 190.5 x 2.7 | 10.13 x 7.5 x 0.106   |
| 5533970500             | FM1193          | GRAPHITE  | SUNBURST          | 72              | INT TH    | 233.4 x 175.5 x 4.0 | 9.19 x 6.91 x 0.156   |
| 5533971100             | FM1305OE        | BRONZE    | RADIAL            | 52              | INT TH    | 148.6 x 107.7 x 2.6 | 5.85 x 4.24 x 0.102   |
| 5535156800             | FM1324MP        | STEEL     | -----             | 54              | EXT TH    | 139.2 x 98.6 x 1.8  | 5.48 x 3.88 x 0.07    |
| 5535318300             | FM1337OE        | BRONZE    | RADIAL            | 45              | INT TH    | 133.1 x 92.7 x 2.3  | 5.24 x 3.65 x 0.09    |
| 5535599600             | FM1375OE        | BRONZE    | RADIAL            | 45              | INT TH    | 133.1 x 92.7 x 2.4  | 5.24 x 3.65 x 0.093   |
| 5536533200             | FM1278MP        | STEEL     | -----             | 14              | (20)EX TH | 218.9 x 158.8 x 2.7 | 8.62 x 6.25 x 0.106   |
| 5536713400             | FM1381OE        | BRONZE    | RADIAL            | 52              | INT TH    | 148.6 x 107.7 x 2.9 | 5.85 x 4.24 x 0.114   |
| 5536981600             | FM1723          | GRAPHITE  | SUNBURST          | 36              | INT TH    | 394.5 x 222.3 x 6.2 | 15.53 x 8.75 x 0.245  |
| 5537035800             | FM1779          | GRAPHITE  | SUNBURST          | 34              | (38)IN TH | 456.7 x 313.7 x 7.8 | 17.98 x 12.35 x 0.308 |
| 5537393200             | FM7982MP        | STEEL     | SUNBURST          | 16              | EXT TH    | 176.2 x 103.5 x 3.9 | 6.94 x 4.07 x 0.155   |
| 5537393300             | FM7980MP        | STEEL     | SUNBURST          | 32              | (36)IN TH | 156.8 x 89.0 x 6.4  | 6.17 x 3.5 x 0.25     |
| 5537539200             | FM1726MP        | STEEL     | -----             | 12              | EXT LG    | 414.3 x 254.0 x 4.7 | 16.31 x 10.0 x 0.185  |
| 5537885700             | FM2687          | PAPER     | WAFFLE            | 48              | INT TH    | 400.0 x 240.0 x 4.7 | 15.74 x 9.46 x 0.184  |
| 5537885800             | FM2690MP        | STEEL     | -----             | 12              | EXT LG    | 421.6 x 254.0 x 3.2 | 16.6 x 10.01 x 0.126  |
| 5540059200             | FM2901          | BRONZE    | RADIAL            | 61              | INT TH    | 449.6 x 305.3 x 4.7 | 17.7 x 12.02 x 0.185  |
| 5540059300             | FM2904MP        | STEEL     | -----             | 12              | EXT LG    | 472.9 x 336.5 x 3.2 | 18.62 x 13.25 x 0.126 |
| 5540863500             | FM2718MP        | STEEL     | -----             | 4               | EXT LG    | 129.0 x 76.0 x 1.5  | 5.08 x 2.99 x 0.059   |
| 5540863600             | FM2719          | PAPER     | 2 PASS            | 33              | INT TH    | 117.9 x 68.1 x 2.2  | 4.65 x 2.68 x 0.087   |
| 5540904000             | FM2690MP        | STEEL     | -----             | 12              | EXT LG    | 421.6 x 254.0 x 3.2 | 16.6 x 10.01 x 0.126  |
| 5540916500             | FM2687          | PAPER     | WAFFLE            | 48              | INT TH    | 400.0 x 240.0 x 4.7 | 15.74 x 9.46 x 0.184  |
| 5540936300             | FM6991          | BRONZE    | RADIAL            | 60              | INT TH    | 169.0 x 124.6 x 3.3 | 6.65 x 4.91 x 0.128   |
| 5540981100             | FM5926MP        | STEEL     | -----             | 69              | EXT TH    | 177.0 x 132.0 x 1.9 | 6.97 x 5.2 x 0.075    |
| 5540981200             | FM5923          | PAPER     | 2 PASS            | 60              | INT TH    | 169.0 x 124.6 x 2.8 | 6.65 x 4.91 x 0.11    |
| 5540991200             | FM5311          | PAPER     | WAFFLE            | 61              | INT TH    | 449.3 x 305.3 x 4.8 | 17.69 x 12.02 x 0.189 |
| 5540991300             | FM2904MP        | STEEL     | -----             | 12              | EXT LG    | 472.9 x 336.5 x 3.2 | 18.62 x 13.25 x 0.126 |
| 5541184400             | FM1294MP        | STEEL     | -----             | 30              | (90)EX TH | 387.4 x 321.8 x 5.0 | 15.25 x 12.67 x 0.195 |
| 5541285800             | FM4486MP        | STEEL     | HARDENED          | 60              | EXT TH    | 154.2 x 113.8 x 1.8 | 6.07 x 4.48 x 0.07    |
| 5541489000             | FM5926MP        | STEEL     | -----             | 69              | EXT TH    | 177.0 x 132.0 x 1.9 | 6.97 x 5.2 x 0.075    |
| 5541511000             | FM2738MP        | STEEL     | -----             | 71              | EXT TH    | 182.6 x 117.9 x 1.8 | 7.19 x 4.64 x 0.069   |
| 5541606600             | FM4036MP        | END PLATE | STEPPED           | 4               | EXT LG    | 129.0 x 74.0 x 5.0  | 5.08 x 2.91 x 0.197   |
| 5541733800             | FM1296MP        | STEEL     | -----             | 30              | (90)EX TH | 387.4 x 321.8 x 3.0 | 15.25 x 12.67 x 0.12  |
| 5542004300             | FM5923          | PAPER     | 2 PASS            | 60              | INT TH    | 169.0 x 124.6 x 2.8 | 6.65 x 4.91 x 0.11    |
| 5542008700             | FM2686MP        | STEEL     | -----             | 48              | (96)EX TH | 499.1 x 337.8 x 4.8 | 19.65 x 13.3 x 0.187  |
| 5542011000             | FM8118MP        | STEEL     | END PLATE         | 69              | EXT TH    | 176.0 x 131.9 x 6.2 | 6.93 x 5.19 x 0.244   |
| 5580002122             | FM5233          | CARBON PA | 2 PASS            | 72              | INT TH    | 233.4 x 175.5 x 4.0 | 9.19 x 6.91 x 0.156   |

| REPLACES OEM PT.NO. | FMC PART NO. | MATERIAL  | GROOVE DETAILS | TEETH/TANGS | SIZE MM   | SIZE INCH                                 |
|---------------------|--------------|-----------|----------------|-------------|-----------|---|
| 5580002186          | FM1782MP     | STEEL     | -----          | 9           | EXT LG    | 477.8 x 338.6 x 4.7 18.81 x 13.33 x 0.185 |
| 5580004741          | FM6339       | CARBON PA | 3 PASS         | 36          | INT TH    | 394.5 x 222.3 x 5.2 15.53 x 8.75 x 0.204  |
| 5580006011          | FM5159       | CARBON PA | 3 PASS         | 34          | (38)IN TH | 456.7 x 313.7 x 6.8 17.98 x 12.35 x 0.268 |
| 5580011249          | FM6018MP     | STEEL     | -----          | 78          | EXT TH    | 200.0 x 114.0 x 3.0 7.87 x 4.49 x 0.118   |
| 5580011312          | FM6016MP     | STEEL     | -----          | 78          | EXT TH    | 200.0 x 114.0 x 2.3 7.87 x 4.49 x 0.089   |
| 5580013920          | FM6864MP     | STEEL     | -----          | 24          | EXT LG    | 501.0 x 338.0 x 4.8 19.72 x 13.31 x 0.189 |
| 5580018098          | FM8172MP     | STEEL     | -----          | 24          | EXT LG    | 485.9 x 310.1 x 4.0 19.13 x 12.21 x 0.157 |
| 5580021479          | FM6435       | CARBON PA | WAFFLE         | 52          | INT TH    | 193.0 x 107.5 x 2.6 7.6 x 4.23 x 0.102    |
| 5580021523          | FM5376MP     | STEEL     | -----          | 45          | INT TH    | 148.3 x 92.7 x 2.3 5.84 x 33.65 x 0.089   |
| 5580021524          | FM6437       | CARBON PA | WAFFLE         | 60          | EXT TH    | 154.0 x 99.0 x 2.7 6.06 x 3.9 x 0.104     |
| 5580021525          | FM6439       | CARBON PA | WAFFLE/PLAIN   | 60          | EXT TH    | 154.0 x 99.0 x 1.9 6.06 x 3.9 x 0.075     |
| 5580101906          | FM8169       | PAPER     | WAFFLE         | 62          | INT TH    | 465.5 x 292.3 x 5.6 18.32 x 11.51 x 0.141 |
| 5590001180          | FM3007       | PAPER     | 3 PASS         | 60          | INT TH    | 466.0 x 284.0 x 5.6 18.35 x 11.18 x 0.22  |
| 5590001971          | FM5237       | CARBON PA | 2 PASS         | 60          | INT TH    | 292.0 x 207.0 x 4.0 11.5 x 8.15 x 0.156   |
| 5590001242          | FM5578MP     | STEEL     | -----          | 96          | EXT TH    | 488.0 x 310.0 x 4.0 19.21 x 12.2 x 0.157  |
| 5590003620          | FM8061       | PAPER     | WAFFLE         | 79          | INT TH    | 550.0 x 391.0 x 5.5 21.65 x 15.39 x 0.217 |
| 5590007522          | FM8064MP     | STEEL     | -----          | 24          | EXT TH    | 570.0 x 416.0 x 4.0 22.44 x 16.38 x 0.157 |
| 5590009350          | FM8061       | PAPER     | WAFFLE         | 79          | INT TH    | 550.0 x 391.0 x 5.5 21.65 x 15.39 x 0.217 |
| 8440300420          | FM4606MP     | STEEL     | -----          | 3           | EXT LG    | 216.9 x 144.0 x 2.7 8.54 x 5.67 x 0.106   |
| 8440300562          | FM4625       | PAPER     | SUNBURST       | 16          | INT TH    | 201.0 x 40.5 x 4.9 7.91 x 1.59 x 0.192    |

### WARNER GEAR

|               |          |          |            |    |           |   |
|---------------|----------|----------|------------|----|-----------|---|
| Mar-37        | FM4222SP | STEEL    | SPRING     | 8  | INT TH    | 134.7 x 73.6 x 1.8 5.3 x 2.9 x 0.071    |
| Mar-65        | FM1276MP | STEEL    | DISHED     | 50 | (54)EX TH | 138.9 x 98.0 x 1.8 5.47 x 3.86 x 0.07   |
| 3-176         | FM1324MP | STEEL    | -----      | 54 | EXT TH    | 139.2 x 98.6 x 1.8 5.48 x 3.88 x 0.07   |
| 5C-175A       | FM5442MP | STEEL    | END PLATE  | 54 | EXT TH    | 139.2 x 98.2 x 8.3 5.48 x 3.87 x 0.327  |
| 5L-67         | FM5452MP | STEEL    | END PLATE  | 54 | EXT TH    | 139.2 x 98.2 x 8.7 5.48 x 3.87 x 0.343  |
| 22-176        | FM1900MP | STEEL    | -----      | 64 | EXT TH    | 205.5 x 145.3 x 1.7 8.09 x 5.72 x 0.067 |
| 72-A66        | FM5791   | BRONZE   | RADIAL     | 59 | INT TH    | 190.8 x 147.3 x 1.5 7.51 x 5.8 x 0.059  |
| 72/A66B       | FM1933   | BRONZE   | RADIAL     | 59 | INT TH    | 190.8 x 147.3 x 3.0 7.51 x 5.8 x 0.118  |
| 72/176        | FM1938MP | STEEL    | -----      | 3  | EXT LG    | 214.9 x 155.7 x 1.8 8.46 x 6.13 x 0.07  |
| SK4461'65-G   | FM1276MP | STEEL    | DISHED     | 50 | (54)EX TH | 138.9 x 98.0 x 1.8 5.47 x 3.86 x 0.07   |
| 3A66          | FM1359   | BRONZE   | SPIRAL     | 45 | INT TH    | 133.1 x 92.7 x 1.6 5.24 x 3.65 x 0.063  |
| 12A66         | FM1649   | PAPER    | 2 PASS     | 45 | INT TH    | 133.1 x 92.7 x 1.6 5.24 x 3.65 x 0.063  |
| 35A333        | FM1327   | OBSOLETE | SUNBURST   | 36 | INT TH    | 177.3 x 111.0 x 3.2 6.98 x 4.37 x 0.125 |
| 35A334        | FM1242MP | STEEL    | -----      | 58 | EXT TH    | 186.4 x 121.2 x 1.7 7.34 x 4.77 x 0.065 |
| 5C-A66A       | FM1935   | BRONZE   | 240 RADIAL | 45 | INT TH    | 133.1 x 92.7 x 1.6 5.24 x 3.65 x 0.063  |
| AT-220-66     | FM1247OE | BRONZE   | SUNBURST   | 43 | (44)IN TH | 196.9 x 137.7 x 2.8 7.75 x 5.42 x 0.109 |
| T22176A       | FM1900MP | STEEL    | -----      | 64 | EXT TH    | 205.5 x 145.3 x 1.7 8.09 x 5.72 x 0.067 |
| 10-08-166-001 | FM3384MP | STEEL    | -----      | 43 | (64)EX TH | 205.5 x 145.4 x 3.5 8.09 x 5.72 x 0.138 |
| 10-08-666-001 | FM1247OE | BRONZE   | SUNBURST   | 43 | (44)IN TH | 196.9 x 137.7 x 2.8 7.75 x 5.42 x 0.109 |
| 10-08-666-004 | FM3667   | PAPER    | 2 PASS     | 44 | INT TH    | 196.9 x 138.0 x 2.8 7.75 x 5.43 x 0.11  |
| 10-16-166-001 | FM1324MP | STEEL    | -----      | 54 | EXT TH    | 139.2 x 98.6 x 1.8 5.48 x 3.88 x 0.07   |
| 10-17-666-001 | FM3571   | PAPER    | 2 PASS     | 59 | INT TH    | 190.8 x 147.3 x 3.0 7.51 x 5.8 x 0.118  |
| 10-21-166-001 | FM3650MP | STEEL    | -----      | 54 | EXT TH    | 139.2 x 98.6 x 3.0 5.48 x 3.88 x 0.118  |
| 10-21-666-002 | FM2829   | PAPER    | 2 PASS     | 45 | INT TH    | 133.1 x 92.7 x 2.1 5.24 x 3.65 x 0.083  |
| 10-21-666-003 | FM2829   | PAPER    | 2 PASS     | 45 | INT TH    | 133.1 x 92.7 x 2.1 5.24 x 3.65 x 0.083  |



| REPLACES<br>OEM PT.NO. |                 | FMC<br>PART NO. | MATERIAL  | GROOVE<br>DETAILS | TEETH/<br>TANGS | SIZE MM |       |   |       | SIZE INCH |     |      |   |      |   |       |
|------------------------|-----------------|-----------------|-----------|-------------------|-----------------|---------|-------|---|-------|-----------|-----|------|---|------|---|-------|
|                        | 10-21-666-005   | FM2829          | PAPER     | 2 PASS            | 45              | INT TH  | 133.1 | x | 92.7  | x         | 2.1 | 5.24 | x | 3.65 | x | 0.083 |
|                        | 20-3000-390     | FM1235          | OBSOLETE  | SUNBURST          | 36              | INT TH  | 177.8 | x | 111.0 | x         | 3.2 | 7.0  | x | 4.37 | x | 0.126 |
|                        | 20-3009-180     | FM1241          | OBSOLETE  | SUNBURST          | 58              | EXT TH  | 186.4 | x | 121.2 | x         | 2.5 | 7.34 | x | 4.77 | x | 0.1   |
|                        | 3-645-154-20210 | FM1361OE        | BRONZE    | SUNBURST          | 45              | INT TH  | 133.1 | x | 92.7  | x         | 1.6 | 5.24 | x | 3.65 | x | 0.063 |
| <b>WINGET</b>          |                 |                 |           |                   |                 |         |       |   |       |           |     |      |   |      |   |       |
|                        | V601521         | FM2781          | GRAPHITE  | SUNBURST          | 15              | INT TH  | 213.0 | x | 44.0  | x         | 10  | 8.38 | x | 1.73 | x | 0.394 |
|                        | V602886         | FM3912MP        | END PLATE | -----             | 64              | EXT TH  | 230.0 | x | 152.5 | x         | 5.0 | 9.06 | x | 6.0  | x | 0.197 |
| <b>XTREME</b>          |                 |                 |           |                   |                 |         |       |   |       |           |     |      |   |      |   |       |
|                        | 14105-020       | FM2825          | BRONZE    | SUNBURST          | 45              | INT TH  | 133.0 | x | 93.0  | x         | 1.8 | 5.24 | x | 3.66 | x | 0.069 |
|                        | 14105-028       | FM3667          | PAPER     | 2 PASS            | 44              | INT TH  | 196.9 | x | 138.0 | x         | 2.8 | 7.75 | x | 5.43 | x | 0.11  |

| REPLACES<br>OEM PT.NO. | FMC<br>PART NO. | MATERIAL  | GROOVE<br>DETAILS | TEETH/<br>TANGS | SIZE MM   | SIZE INCH                                |
|------------------------|-----------------|-----------|-------------------|-----------------|-----------|--|
| <b>YALE</b>            |                 |           |                   |                 |           |  |
| 630 243                | FM0419          | BRONZE    | SPR/WAG           | 37              | EXT TH    | 192.0 x 117.6 x 2.4 7.56 x 4.63 x 0.094  |
| 641 409                | FM2032MP        | STEEL     | -----             | 36              | (42)IN TH | 176.3 x 102.6 x 2.0 6.94 x 4.04 x 0.079  |
| 4907850                | FM1900MP        | STEEL     | -----             | 64              | EXT TH    | 205.5 x 145.3 x 1.7 8.09 x 5.72 x 0.067  |
| 059-217-900            | FM1900MP        | STEEL     | -----             | 64              | EXT TH    | 205.5 x 145.3 x 1.7 8.09 x 5.72 x 0.067  |
| 059-218-000            | FM1247OE        | BRONZE    | SUNBURST          | 43              | (44)IN TH | 196.9 x 137.7 x 2.8 7.75 x 5.42 x 0.109  |
| 0805288-00             | FM3382FP        | STEEL     | FLEXI PLATE       | 6               | HOLE      | 339.7 x 133.4 x 1.5 13.37 x 5.25 x 0.059 |
| 1341424-00             | FM4442FP        | STEEL     | REINF PLATE       | 6               | HOLE      | 186.5 x 132.0 x 2.1 7.34 x 5.2 x 0.83    |
| 1341464-00             | FM3382FP        | STEEL     | FLEXI PLATE       | 6               | HOLE      | 339.7 x 133.4 x 1.5 13.37 x 5.25 x 0.059 |
| 1368471-00             | FM3382KIT       | STEEL     | FLEXI PLATE       |                 |           |  |
| 2200125-94             | FM4036MP        | END PLATE | STEPPED           | 4               | EXT LG    | 129.0 x 74.0 x 5.0 5.08 x 2.91 x 0.197   |
| 505-971-559            | FM2829          | PAPER     | 2 PASS            | 45              | INT TH    | 133.1 x 92.7 x 2.1 5.24 x 3.65 x 0.083   |
| 505-971-578            | FM3650MP        | STEEL     | -----             | 54              | EXT TH    | 139.2 x 98.6 x 3.0 5.48 x 3.88 x 0.118   |
| 514-132-600            | FM2034MP        | STEEL     | -----             | 35              | (39)IN TH | 136.7 x 60.5 x 1.8 5.38 x 2.38 x 0.072   |
| 518-470-818            | FM3650MP        | STEEL     | -----             | 54              | EXT TH    | 139.2 x 98.6 x 3.0 5.48 x 3.88 x 0.118   |
| 518-470-819            | FM2829          | PAPER     | 2 PASS            | 45              | INT TH    | 133.1 x 92.7 x 2.1 5.24 x 3.65 x 0.083   |
| 519-744-400            | FM2035          | PAPER     | 2 PASS            | 12              | EXT LG    | 147.3 x 81.5 x 2.5 5.8 x 3.21 x 0.1      |
| 580-001-691            | FM4012MP        | END PLATE | -----             | 54              | EXT TH    | 138.8 x 98.8 x 6.3 5.46 x 3.89 x 0.248   |
| 580-014-555            | FM2829          | PAPER     | 2 PASS            | 45              | INT TH    | 133.1 x 92.7 x 2.1 5.24 x 3.65 x 0.083   |
| 580-019-516            | FM3343          | PAPER     | 2 PASS            | 45              | INT TH    | 133.1 x 92.7 x 2.5 5.24 x 3.65 x 0.1     |
| 580-020-036            | FM3346MP        | STEEL     | -----             | 54              | EXT TH    | 139.2 x 98.6 x 2.5 5.48 x 3.88 x 0.1     |
| 580-081-744            | FM8601          | PAPER     | WAFFLE            | 14              | INT TH    | 229.0 x 45.0 x 5.7 9.02 x 1.77 x 0.224   |
| 580-081-745            | FM8604MP        | STEEL     | -----             | 4               | EXT LG    | 250.7 x 179.9 x 5.0 9.87 x 7.08 x 0.197  |
| 750-110-9000           | FM3724MP        | STEEL     | -----             | 8               | EXT LG    | 152.6 x 87.0 x 2.0 6.0 x 3.43 x 0.079    |
| 750-112-5000           | FM2061          | PAPER     | WAFFLE            | 41              | INT TH    | 125.0 x 68.6 x 2.6 4.92 x 2.7 x 0.102    |
| 750-115-5000           | FM2061          | PAPER     | WAFFLE            | 41              | INT TH    | 125.0 x 68.6 x 2.6 4.92 x 2.7 x 0.102    |
| 800-083-842            | FM3343          | PAPER     | 2 PASS            | 45              | INT TH    | 133.1 x 92.7 x 2.5 5.24 x 3.65 x 0.1     |
| 900-485-806            | FM2034MP        | STEEL     | -----             | 35              | (39)IN TH | 136.7 x 60.5 x 1.8 5.38 x 2.38 x 0.072   |
| 900-485-807            | FM2035          | PAPER     | 2 PASS            | 12              | EXT LG    | 147.3 x 81.5 x 2.5 5.8 x 3.21 x 0.1      |
| 900-682-813            | FM3721          | BRONZE    | SUN/WAG           | 66              | EXT TH    | 142.6 x 85.7 x 2.8 5.61 x 3.37 x 0.11    |
| 900-682-814            | FM2636MP        | STEEL     | -----             | 38              | INT TH    | 133.0 x 77.0 x 1.5 5.24 x 3.03 x 0.059   |
| 900-952-803            | FM2352MP        | STEEL     | -----             | 8               | EXT LG    | 149.9 x 87.4 x 2.3 5.9 x 3.44 x 0.091    |
| 900-952-804            | FM2135          | PAPER     | 2 PASS            | 38              | INT TH    | 133.6 x 77.0 x 2.8 5.26 x 3.03 x 0.11    |
| 900-952-824            | FM3727          | PAPER     | 2 PASS            | 38              | INT TH    | 133.6 x 77.0 x 3.0 5.26 x 3.03 x 0.118   |
| 901-194-880            | FM4094MP        | STEEL     | -----             | 8               | EXT LG    | 136.2 x 80.0 x 1.6 5.37 x 3.15 x 0.063   |
| 902-152-850            | FM2642MP        | STEEL     | -----             | 42              | EXT TH    | 131.4 x 80.0 x 1.6 5.17 x 3.15 x 0.063   |
| ?                      | FM3940MP        | STEEL     | DISHED            | 54              | EXT TH    | 139.4 x 88.0 x 2.5 5.49 x 3.46 x 0.098   |
| ?                      | FM3942MP        | STEEL     | DISHED            | 54              | EXT TH    | 139.4 x 88.0 x 3.6 5.49 x 3.46 x 0.144   |
| ?                      | FM3944MP        | END PLATE | -----             | 54              | EXT TH    | 139.4 x 88.0 x 6.2 5.49 x 3.46 x 0.244   |
| <b>YANMAR</b>          |                 |           |                   |                 |           |  |
| E1903102714            | FM5011          | PAPER     | 2 PASS            | 27              | INT TH    | 78.0 x 54.0 x 1.7 3.07 x 2.13 x 0.067    |
| ?                      | FM3923          | PAPER     | 2 PASS            | 16              | INT TH    | 116.0 x 27.0 x 4.0 4.57 x 1.06 x 0.157   |
| 198200-36380           | FM7849          | PAPER     | 2 PASS            | 16              | INT TH    | 114.0 x 26.7 x 3.4 4.49 x 1.05 x 0.134   |
| 198200-36390           | FM7852MP        | STEEL     | -----             | 2               | EXT LG    | 133.0 x 70.0 x 3.2 5.24 x 2.76 x 0.126   |

| REPLACES OEM PT.NO. | FMC PART NO. | MATERIAL | GROOVE DETAILS | TEETH/TANGS | SIZE MM |       |   |      | SIZE INCH |     |      |   |      |   |       |
|---------------------|--------------|----------|----------------|-------------|---------|-------|---|------|-----------|-----|------|---|------|---|-------|
| <b>ZETOR</b>        |              |          |                |             |         |       |   |      |           |     |      |   |      |   |       |
| 93-0194             | FM2971       | BRONZE   | WAFFLE         | 22          | INT TH  | 71.7  | x | 44.0 | x         | 2.8 | 2.82 | x | 1.73 | x | 0.11  |
| 93-0195             | FM3474MP     | STEEL    | -----          | 4           | EXT LG  | 85.0  | x | 49.2 | x         | 1.5 | 3.35 | x | 1.94 | x | 0.059 |
| 93-0196             | FM2969       | BRONZE   | WAFFLE         | 22          | INT TH  | 71.7  | x | 44.0 | x         | 1.6 | 2.82 | x | 1.73 | x | 0.063 |
| 93-0276             | FM9485       | GRAPHITE | SUNBURST       | 12          | INT TH  | 170.0 | x | 32.7 | x         | 4.8 | 6.69 | x | 1.29 | x | 0.189 |

|                    |          |        |          |    |           |       |   |       |   |     |       |   |       |   |       |
|--------------------|----------|--------|----------|----|-----------|-------|---|-------|---|-----|-------|---|-------|---|-------|
| <b>ZETTLEMEYER</b> |          |        |          |    |           |       |   |       |   |     |       |   |       |   |       |
| 2901867            | FM2647   | PAPER  | 2 PASS   | 19 | INT TH    | 178.0 | x | 34.0  | x | 4.8 | 7.01  | x | 1.34  | x | 0.189 |
| 2-171 180-1        | FM3021   | BRONZE | SUNBURST | 87 | INT TH    | 306.0 | x | 258.0 | x | 3.0 | 12.05 | x | 10.16 | x | 0.118 |
| 2-171 190-9        | FM3024MP | STEEL  | -----    | 12 | EXT LG    | 317.7 | x | 268.0 | x | 3.0 | 12.51 | x | 10.55 | x | 0.118 |
| 2200 2405          | FM2277   | BRONZE | SUNBURST | 27 | EXT TH    | 137.4 | x | 90.9  | x | 2.0 | 5.41  | x | 3.58  | x | 0.079 |
| 2258 6601          | FM2279   | BRONZE | SUNBURST | 35 | EXT TH    | 177.5 | x | 109.0 | x | 2.0 | 6.99  | x | 4.29  | x | 0.079 |
| 2258 6709          | FM3604MP | STEEL  | -----    | 35 | INT TH    | 170.9 | x | 102.9 | x | 2.5 | 6.73  | x | 4.05  | x | 0.098 |
| 2258 6806          | FM3602MP | STEEL  | -----    | 35 | INT TH    | 170.9 | x | 102.9 | x | 2.0 | 6.73  | x | 4.05  | x | 0.079 |
| 2258 6814          | FM3600MP | STEEL  | -----    | 35 | INT TH    | 170.9 | x | 102.9 | x | 1.5 | 6.73  | x | 4.05  | x | 0.059 |
| 2282 6840          | FM2279   | BRONZE | SUNBURST | 35 | EXT TH    | 177.5 | x | 109.0 | x | 2.0 | 6.99  | x | 4.29  | x | 0.079 |
| 2283 3498          | FM3606MP | STEEL  | -----    | 88 | (91)EX TH | 293.0 | x | 185.0 | x | 4.0 | 11.54 | x | 7.28  | x | 0.157 |
| 2283 3501          | FM2811   | PAPER  | 4 PASS   | 34 | INT TH    | 277.0 | x | 167.0 | x | 4.5 | 10.91 | x | 6.57  | x | 0.177 |
| 2283 8180          | FM3612MP | STEEL  | -----    | 91 | EXT TH    | 355.0 | x | 217.0 | x | 5.0 | 13.98 | x | 8.54  | x | 0.197 |
| 2283 8198          | FM2815   | PAPER  | 4 PASS   | 42 | INT TH    | 340.0 | x | 206.0 | x | 5.5 | 13.39 | x | 8.11  | x | 0.217 |
| 2285 2123          | FM3608MP | STEEL  | -----    | 88 | (91)EX TH | 293.0 | x | 185.0 | x | 4.5 | 11.54 | x | 7.28  | x | 0.177 |
| 2286 9794          | FM3614MP | STEEL  | -----    | 91 | EXT TH    | 355.0 | x | 217.0 | x | 5.5 | 13.98 | x | 8.54  | x | 0.217 |
| 2290 6851          | FM2811   | PAPER  | 4 PASS   | 34 | INT TH    | 277.0 | x | 167.0 | x | 4.5 | 10.91 | x | 6.57  | x | 0.177 |
| 2290 7025          | FM2815   | PAPER  | 4 PASS   | 42 | INT TH    | 340.0 | x | 206.0 | x | 5.5 | 13.39 | x | 8.11  | x | 0.217 |

|              |          |             |              |    |        |       |   |       |   |     |       |   |       |   |       |
|--------------|----------|-------------|--------------|----|--------|-------|---|-------|---|-----|-------|---|-------|---|-------|
| <b>Z.F.</b>  |          |             |              |    |        |       |   |       |   |     |       |   |       |   |       |
| 0000 475 824 | FM5137   | BRONZE      | SUNBURST     | 65 | EXT TH | 137.0 | x | 105.2 | x | 2.0 | 5.39  | x | 4.14  | x | 0.079 |
| 0000 475 825 | FM5140MP | STEEL       | -----        | 36 | INT TH | 130.0 | x | 90.0  | x | 2.0 | 5.12  | x | 3.54  | x | 0.079 |
| 0007 302 727 | FM7019   | PAPER       | 2 PASS       | 24 | INT TH | 143.0 | x | 110.0 | x | 1.6 | 5.63  | x | 4.33  | x | 0.064 |
| 0212 120 215 | FM6901   | BRONZE      | WAFFLE       | 6  | EXT LG | 136.4 | x | 92.0  | x | 2.4 | 5.37  | x | 3.62  | x | 0.094 |
| 0212 120 315 | FM6904MP | STEEL       | -----        | 21 | INT TH | 122.6 | x | 82.1  | x | 1.5 | 4.83  | x | 3.23  | x | 0.059 |
| 0501 201 291 | FM5967   | PAPER       | WAFFLE       | 40 | INT TH | 119.7 | x | 79.0  | x | 1.6 | 4.71  | x | 3.11  | x | 0.063 |
| 0501 207 128 | FM4397   | BRONZE      | SUNBURST     | 64 | EXT TH | 196.0 | x | 142.0 | x | 2.5 | 7.72  | x | 5.59  | x | 0.096 |
| 0501 208 067 | FM2815   | PAPER       | 4 PASS       | 42 | INT TH | 340.0 | x | 206.0 | x | 5.5 | 13.39 | x | 8.11  | x | 0.217 |
| 0501 208 264 | FM2811   | PAPER       | 4 PASS       | 34 | INT TH | 277.0 | x | 167.0 | x | 4.5 | 10.91 | x | 6.57  | x | 0.177 |
| 0501 208 435 | FM2815   | PAPER       | 4 PASS       | 42 | INT TH | 340.0 | x | 206   | x | 5.5 | 13.39 | x | 8.11  | x | 0.217 |
| 0501 208 457 | FM2811   | PAPER       | 4 PASS       | 34 | INT TH | 277.0 | x | 167.0 | x | 4.5 | 10.91 | x | 6.57  | x | 0.177 |
| 0501 208 883 | FM4397   | BRONZE      | SUNBURST     | 64 | EXT TH | 196.0 | x | 142.0 | x | 2.5 | 7.72  | x | 5.59  | x | 0.096 |
| 0501 208 884 | FM4399   | BRNZ/PLN    | SUNBURST     | 64 | EXT TH | 196.0 | x | 142.0 | x | 2.0 | 7.72  | x | 5.59  | x | 0.077 |
| 0501 209 446 | FM3801   | PAPER       | RADIAL       | 30 | INT LG | 329.0 | x | 285.0 | x | 3.0 | 12.96 | x | 11.24 | x | 0.117 |
| 0501 210 131 | FM3573   | PAPER       | 2 PASS       | 35 | EXT TH | 177.5 | x | 109.0 | x | 2.0 | 6.99  | x | 4.29  | x | 0.079 |
| 0501 210 138 | FM6781   | CARBON PA   | RADIAL       | 64 | EXT TH | 196.0 | x | 142.0 | x | 2.6 | 7.72  | x | 5.59  | x | 0.1   |
| 0501 210 139 | FM6783   | CARBON PA   | RADIAL/PLAIN | 64 | EXT TH | 196.0 | x | 142.0 | x | 2.0 | 7.72  | x | 5.59  | x | 0.079 |
| 0501 210 290 | FM6337   | PAPER       | WAFFLE/WAVED | 40 | INT TH | 119.7 | x | 79.0  | x | 1.6 | 4.71  | x | 3.11  | x | 0.063 |
| 0501 210 916 | FM6111   | CARBON PA   | RADIAL       | 27 | EXT TH | 137.0 | x | 93.7  | x | 2.5 | 5.39  | x | 3.69  | x | 0.098 |
| 0501 210 917 | FM4787   | CARBON PA   | RADIAL       | 44 | EXT TH | 158.8 | x | 111.5 | x | 2.5 | 6.25  | x | 4.39  | x | 0.098 |
| 0501 210 918 | FM4783   | CARBON PA   | RADIAL       | 34 | EXT TH | 177.4 | x | 111.5 | x | 2.5 | 6.98  | x | 4.39  | x | 0.098 |
| 0501 210 920 | FM4789   | PAPER/PLAIN | RADIAL       | 44 | EXT TH | 158.8 | x | 111.5 | x | 1.9 | 6.25  | x | 4.39  | x | 0.075 |

| REPLACES<br>OEM PT.NO. | FMC<br>PART NO. | MATERIAL    | GROOVE<br>DETAILS | TEETH/<br>TANGS | SIZE MM | SIZE INCH           |                       |
|------------------------|-----------------|-------------|-------------------|-----------------|---------|---------------------|-----------------------|
| 0501 210 921           | FM4785          | PAPER/PLAIN | RADIAL            | 34              | EXT TH  | 177.4 x 111.5 x 1.9 | 6.98 x 4.39 x 0.075   |
| 0501 212 249           | FM4869          | AFP         | 3 PASS            | 66              | INT TH  | 378.0 x 326.0 x 3.1 | 14.88 x 12.83 x 0.12  |
| 0501 212 249           | FM7555          | PAPER       | 3 PASS            | 66              | INT TH  | 378.0 x 326.0 x 3.1 | 14.88 x 12.83 x 0.12  |
| 0501 212 368           | FM6113          | PAPER/PLAIN | RADIAL            | 27              | EXT TH  | 137.0 x 93.7 x 1.9  | 5.39 x 3.69 x 0.073   |
| 0501 212 369           | FM6111          | CARBON PA   | RADIAL            | 27              | EXT TH  | 137.0 x 93.7 x 2.5  | 5.39 x 3.69 x 0.098   |
| 0501 212 370           | FM4783          | CARBON PA   | RADIAL            | 34              | EXT TH  | 177.4 x 111.5 x 2.5 | 6.98 x 4.39 x 0.098   |
| 0501 212 371           | FM4785          | PAPER/PLAIN | RADIAL            | 34              | EXT TH  | 177.4 x 111.5 x 1.9 | 6.98 x 4.39 x 0.075   |
| 0501 212 372           | FM4787          | CARBON PA   | RADIAL            | 44              | EXT TH  | 158.8 x 111.5 x 2.5 | 6.25 x 4.39 x 0.098   |
| 0501 212 373           | FM4789          | PAPER/PLAIN | RADIAL            | 44              | EXT TH  | 158.8 x 111.5 x 1.9 | 6.25 x 4.39 x 0.075   |
| 0501 212 443           | FM8681          | PAPER       | WAFFLE            | 78              | INT TH  | 446.0 x 312.0 x 4.8 | 17.56 x 12.28 x 0.187 |
| 0501 212 619           | FM6337          | PAPER       | WAFFLE/WAVED      | 40              | INT TH  | 119.7 x 79.0 x 1.6  | 4.71 x 3.11 x 0.063   |
| 0501 212 620           | FM5967          | PAPER       | WAFFLE            | 40              | INT TH  | 119.7 x 79.0 x 1.6  | 4.71 x 3.11 x 0.063   |
| 0501 213 016           | FM8049          | BRONZE      | WAF/WAG           | 34              | INT TH  | 104.0 x 68.0 x 1.6  | 4.09 x 2.68 x 0.063   |
| 0501 213 150           | FM4727          | PAPER       | 3 PASS            | 59              | INT TH  | 339.0 x 291.0 x 3.0 | 13.35 x 11.46 x 0.118 |
| 0501 213 172           | FM3963          | PAPER       | 2 PASS            | 10              | EXT LG  | 177.0 x 126.0 x 3.0 | 6.97 x 4.97 x 0.117   |
| 0501 213 173           | FM3965          | PAPER       | RADIAL            | 43              | INT TH  | 257.0 x 212.0 x 3.0 | 10.11 x 8.34 x 0.117  |
| 0501 213 174           | FM3967          | PAPER       | RADIAL            | 46              | INT TH  | 278.0 x 228.0 x 2.7 | 10.84 x 8.98 x 0.106  |
| 0501 213 393           | FM4275          | CARBON PA   | RADIAL            | 64              | EXT TH  | 196.0 x 142.0 x 3.4 | 7.72 x 5.59 x 0.132   |
| 0501 214 260           | FM7677          | CARBON PA   | WAFFLE            | 34              | INT TH  | 109.7 x 68.4 x 1.6  | 4.32 x 2.69 x 0.063   |
| 0501 214 901           | FM8159          | BRONZE      | SPR/RAD           | 35              | EXT TH  | 176.5 x 142.0 x 3.3 | 6.95 x 5.59 x 0.128   |
| 0501 215 072           | FM9145          | BRONZE      | WAF/WAG           | 78              | INT TH  | 445.5 x 312.3 x 4.0 | 17.54 x 12.3 x 0.157  |
| 0501 215 074           | FM7247          | GRAPHITE    | SUNBURST          | 20              | INT TH  | 200.0 x 59.0 x 4.3  | 7.87 x 2.32 x 0.169   |
| 0501 215 477           | FM7853          | OBSOLETE    | SUNBURST          | 20              | INT TH  | 200.0 x 59.0 x 4.5  | 7.87 x 2.32 x 0.177   |
| 0501 216 833           | FM7685          | PAPER       | WAFFLE            | 12              | EXT LG  | 252.7 x 180.6 x 2.5 | 9.95 x 7.11 x 0.098   |
| 0501 217 387           | FM9155          | PAPER       | WAFFLE            | 50              | EXT TH  | 204.7 x 149.0 x 2.5 | 8.06 x 5.87 x 0.098   |
| 0501 232 652           | FM7677          | CARBON PA   | WAFFLE            | 34              | INT TH  | 109.7 x 68.4 x 1.6  | 4.32 x 2.69 x 0.063   |
| 0501 308 325           | FM2277          | BRONZE      | SUNBURST          | 27              | EXT TH  | 137.4 x 90.9 x 2.0  | 5.41 x 3.58 x 0.079   |
| 0501 308 328           | FM2279          | BRONZE      | SUNBURST          | 35              | EXT TH  | 177.5 x 109.0 x 2.0 | 6.99 x 4.29 x 0.079   |
| 0501 309 265           | FM3021          | BRONZE      | SUNBURST          | 87              | INT TH  | 306.0 x 258.0 x 3.0 | 12.05 x 10.16 x 0.118 |
| 0501 309 326           | FM3021          | BRONZE      | SUNBURST          | 87              | INT TH  | 306.0 x 258.0 x 3.0 | 12.05 x 10.16 x 0.118 |
| 0501 309 329           | FM2277          | BRONZE      | SUNBURST          | 27              | EXT TH  | 137.4 x 90.9 x 2.0  | 5.41 x 3.58 x 0.079   |
| 0501 309 330           | FM2279          | BRONZE      | SUNBURST          | 35              | EXT TH  | 177.5 x 109.0 x 2.0 | 6.99 x 4.29 x 0.079   |
| 0501 309 534           | FM2279          | BRONZE      | SUNBURST          | 35              | EXT TH  | 177.5 x 109.0 x 2.0 | 6.99 x 4.29 x 0.079   |
| 0501 309 541           | FM2279          | BRONZE      | SUNBURST          | 35              | EXT TH  | 177.5 x 109.0 x 2.0 | 6.99 x 4.29 x 0.079   |
| 0501 309 600           | FM2277          | BRONZE      | SUNBURST          | 27              | EXT TH  | 137.4 x 90.9 x 2.0  | 5.41 x 3.58 x 0.079   |
| 0501 310 174           | FM2279          | BRONZE      | SUNBURST          | 35              | EXT TH  | 177.5 x 109.0 x 2.0 | 6.99 x 4.29 x 0.079   |
| 0501 312 249           | FM3021          | BRONZE      | SUNBURST          | 87              | INT TH  | 306.0 x 258.0 x 3.0 | 12.05 x 10.16 x 0.118 |
| 0501 312 280           | FM4123          | BRONZE      | SUN-PLAIN         | 27              | EXT TH  | 137.4 x 90.9 x 1.6  | 5.41 x 3.58 x 0.063   |
| 0501 312 283           | FM4125          | BRONZE      | SUN-PLAIN         | 35              | EXT TH  | 177.5 x 109.0 x 1.6 | 6.99 x 4.29 x 0.063   |
| 0501 313 598           | FM9063          | BRONZE      | SUNBURST          | 27              | EXT TH  | 137.4 x 90.9 x 2.0  | 5.41 x 3.58 x 0.079   |
| 0501 313 802           | FM8329          | BRONZE      | SUNBURST          | 30              | EXT TH  | 118.3 x 77.3 x 2.2  | 4.66 x 3.04 x 0.087   |
| 0501 314 215           | FM9351          | CARBON PA   | 2 PASS            | 34              | INT TH  | 146.7 x 99.7 x 2.1  | 5.78 x 3.93 x 0.083   |
| 0501 314 216           | FM9354MP        | STEEL       | -----             | 8               | EXT LG  | 161.6 x 107.0 x 1.8 | 6.36 x 4.21 x 0.071   |
| 0501 314 381           | FM3353          | BRONZE      | SUN/WAG           | 35              | INT TH  | 179.0 x 103.0 x 3.5 | 7.05 x 4.05 x 0.138   |
| 0501 314 381           | FM3575          | PAPER       | 3 PASS            | 35              | INT TH  | 179.0 x 103.0 x 3.5 | 7.05 x 4.05 x 0.138   |
| 0501 314 382           | FM4089          | PAPER       | 3 PASS            | 48              | INT TH  | 232.7 x 142.0 x 4.0 | 9.16 x 5.59 x 0.157   |
| 0501 314 658           | FM6117          | PAPER       | 3 PASS            | 15              | INT TH  | 232.0 x 43.0 x 5.8  | 9.13 x 1.69 x 0.228   |
| 0501 314 781           | FM4289          | BRONZE      | SPR/RAD           | 35              | EXT TH  | 176.5 x 142.0 x 2.5 | 6.95 x 5.51 x 0.096   |

| REPLACES<br>OEM PT.NO. | FMC<br>PART NO. | MATERIAL  | GROOVE<br>DETAILS | TEETH/<br>TANGS | SIZE MM   |       |   | SIZE INCH |   |     |       |   |       |   |       |
|------------------------|-----------------|-----------|-------------------|-----------------|-----------|-------|---|-----------|---|-----|-------|---|-------|---|-------|
| 0501 314 782           | FM4291          | BRNZ/PLN  | SPR/RAD           | 35              | EXT TH    | 176.5 | x | 142       | x | 2.0 | 6.95  | x | 5.51  | x | 0.077 |
| 0501 315 964           | FM5970MP        | STEEL     | -----             | 30              | EXT TH    | 130.9 | x | 86.8      | x | 1.8 | 5.15  | x | 3.42  | x | 0.071 |
| 0501 315 974           | FM6117          | PAPER     | 3 PASS            | 15              | INT TH    | 232.0 | x | 43.0      | x | 5.8 | 9.13  | x | 1.69  | x | 0.228 |
| 0501 316 027           | FM8595          | CARBON PA | RADIAL            | 35              | EXT TH    | 176.5 | x | 142.0     | x | 2.5 | 6.95  | x | 5.51  | x | 0.096 |
| 0501 316 028           | FM8597          | CARBON PA | RADIAL/PLAIN      | 35              | EXT TH    | 176.5 | x | 142.0     | x | 1.9 | 6.95  | x | 5.51  | x | 0.073 |
| 0501 316 590           | FM6116MP        | STEEL     | -----             | 35              | INT TH    | 129.6 | x | 84.8      | x | 2.5 | 5.1   | x | 3.34  | x | 0.098 |
| 0501 316 591           | FM4790MP        | STEEL     | -----             | 42              | INT TH    | 150.9 | x | 102.5     | x | 2.5 | 5.94  | x | 4.04  | x | 0.098 |
| 0501 316 592           | FM4786MP        | STEEL     | -----             | 42              | INT TH    | 167.8 | x | 102.5     | x | 2.5 | 6.61  | x | 4.04  | x | 0.098 |
| 0501 318 589           | FM5906-3.5      | STEEL     | -----             | 8               | EXT LG    | 410.0 | x | 336.0     | x | 3.5 | 16.14 | x | 13.23 | x | 0.138 |
| 0501 318 590           | FM5906-4.0      | STEEL     | -----             | 8               | EXT LG    | 410.0 | x | 336.0     | x | 4.0 | 16.14 | x | 13.23 | x | 0.157 |
| 0501 318 590-4.5       | FM5906-4.5      | STEEL     | -----             | 8               | EXT LG    | 410.0 | x | 336.0     | x | 4.5 | 16.14 | x | 13.23 | x | 0.177 |
| 0501 319 274           | FM5970MP        | STEEL     | -----             | 30              | EXT TH    | 130.9 | x | 86.8      | x | 1.8 | 5.15  | x | 3.42  | x | 0.071 |
| 0501 319 853           | FM5133          | BRONZE    | SUNBURST          | 65              | EXT TH    | 137.0 | x | 105.2     | x | 1.8 | 5.39  | x | 4.14  | x | 0.071 |
| 0501 319 854           | FM5136MP        | STEEL     | -----             | 36              | INT TH    | 130.0 | x | 90.0      | x | 1.8 | 5.12  | x | 3.54  | x | 0.071 |
| 0501 320 305           | FM5590MP        | STEEL     | -----             | 12              | EXT LG    | 368.0 | x | 300.0     | x | 3.5 | 14.49 | x | 11.81 | x | 0.138 |
| 0501 320 306           | FM4730MP        | STEEL     | -----             | 12              | EXT LG    | 368.0 | x | 300.0     | x | 4.0 | 14.49 | x | 11.81 | x | 0.157 |
| 0501 320 306-4.5       | FM4730-4.5      | STEEL     | -----             | 12              | EXT LG    | 368.0 | x | 300.0     | x | 4.5 | 14.49 | x | 11.81 | x | 0.177 |
| 0501 320 969           | FM7711          | PAPER     | WAFFLE            | 36              | INT TH    | 242.5 | x | 72.0      | x | 5.2 | 9.55  | x | 2.83  | x | 0.205 |
| 0501 321 410           | FM7680MP        | STEEL     | DISHED            | 30              | EXT TH    | 119.8 | x | 75.3      | x | 1.8 | 4.72  | x | 2.96  | x | 0.071 |
| 0501 321 596           | FM8567          | BRONZE    | SPR/RAD           | 35              | INT TH    | 235.3 | x | 104.2     | x | 4.2 | 9.26  | x | 4.1   | x | 0.165 |
| 0501 321 598           | FM8570MP        | STEEL     | HARDENED          | 8               | EXT LG    | 247.7 | x | 156.7     | x | 6.0 | 9.75  | x | 6.17  | x | 0.236 |
| 0501 322 140           | FM6417          | BRONZE    | WAF/WAG           | 64              | INT TH    | 345.0 | x | 252.0     | x | 3.8 | 13.58 | x | 9.92  | x | 0.15  |
| 0501 322 355           | FM7521          | PAPER     | 3 PASS            | 48              | INT TH    | 233.0 | x | 141.5     | x | 5.5 | 9.17  | x | 5.57  | x | 0.217 |
| 0501 322 751           | FM5133          | BRONZE    | SUNBURST          | 65              | EXT TH    | 137.0 | x | 105.2     | x | 1.8 | 5.39  | x | 4.14  | x | 0.071 |
| 0501 322 752           | FM5136MP        | STEEL     | -----             | 36              | INT TH    | 130.0 | x | 90.0      | x | 1.8 | 5.12  | x | 3.54  | x | 0.071 |
| 0501 323 004           | FM6715          | CARBON PA | WAFFLE            | 8               | EXT LG    | 262.7 | x | 155.0     | x | 4.5 | 10.34 | x | 6.1   | x | 0.177 |
| 0501 323 005           | FM8429          | CARBON PA | WAFFLE            | 8               | EXT LG    | 240.0 | x | 140.0     | x | 4.5 | 9.45  | x | 5.51  | x | 0.177 |
| 0501 323 108           | FM6444MP        | STEEL     | HARD/BLACK        | 45              | INT TH    | 170.0 | x | 132.7     | x | 2.5 | 6.69  | x | 5.22  | x | 0.098 |
| 0501 323 109           | FM6446MP        | STEEL     | HARD/BLACK        | 45              | INT TH    | 170.0 | x | 132.7     | x | 3.0 | 6.69  | x | 5.22  | x | 0.118 |
| 0501 323 110           | FM6522MP        | STEEL     | HARD/BLACK        | 45              | INT TH    | 170.0 | x | 132.7     | x | 3.5 | 6.69  | x | 5.22  | x | 0.138 |
| 0501 323 111           | FM6522-4.0      | OBSOLETE  | HARD/BLACK        | 45              | INT TH    | 170.0 | x | 132.7     | x | 4.0 | 6.69  | x | 5.22  | x | 0.157 |
| ALTERNATIVE            | FM6522-4.5      | STEEL     | HARD/BLACK        | 45              | INT TH    | 170.0 | x | 132.6     | x | 4.5 | 6.69  | x | 5.22  | x | 0.177 |
| 0501 323 352           | FM7449          | PAPER/STL | WAFFLE            | 20              | EXT LG    | 373.4 | x | 262.6     | x | 3.4 | 14.7  | x | 10.34 | x | 0.134 |
| 0501 323 355           | FM7523          | PAPER     | 3 PASS            | 20              | INT TH    | 233.0 | x | 59.5      | x | 5.5 | 9.17  | x | 2.34  | x | 0.217 |
| 0501 323 456           | FM7526MP        | STEEL     | -----             | 4               | EXT LG    | 251.0 | x | 153.6     | x | 4.0 | 9.88  | x | 6.05  | x | 0.157 |
| 0501 324 099           | FM5899          | GRAPHITE  | SUNBURST          | 28              | INT TH    | 242.6 | x | 56.1      | x | 4.8 | 9.55  | x | 2.21  | x | 0.189 |
| 0501 324 153           | FM8483          | GRAPHITE  | SUN/RAD           | 28              | INT TH    | 242.6 | x | 56.1      | x | 4.8 | 9.55  | x | 2.21  | x | 0.189 |
| 0501 324 155           | FM7274MP        | STEEL     | -----             | 2               | EXT LG    | 288.0 | x | 156.0     | x | 3.0 | 11.34 | x | 6.14  | x | 0.118 |
| 0501 324 156           | FM7714MP        | STEEL     | -----             | 2               | EXT LG    | 248.0 | x | 156.0     | x | 5.0 | 9.76  | x | 6.14  | x | 0.197 |
| 0501 324 785           | FM7856MP        | STEEL     | -----             | 5               | EXT LG    | 214.7 | x | 144.4     | x | 3.0 | 8.45  | x | 5.69  | x | 0.118 |
| 0501 324 834           | FM8592MP        | STEEL     | HARDENED          | 41              | INT TH    | 177.7 | x | 119.5     | x | 2.0 | 7     | x | 4.7   | x | 0.079 |
| 0501 325 244           | FM7526MP        | STEEL     | -----             | 4               | EXT LG    | 251.0 | x | 153.6     | x | 4.0 | 9.88  | x | 6.05  | x | 0.157 |
| 0501 332 094           | FM7573          | BRONZE    | SUN/ IND HARD     | 35              | EXT TH    | 177.5 | x | 109.0     | x | 2.0 | 6.99  | x | 4.29  | x | 0.079 |
| 0501 332 095           | FM2277          | BRONZE    | SUNBURST          | 27              | EXT TH    | 137.4 | x | 90.9      | x | 2.0 | 5.41  | x | 3.58  | x | 0.079 |
| 0501 348 023           | FM7132-2.5      | STEEL     | -----             | 36              | (48)IN TH | 236.0 | x | 144.2     | x | 2.5 | 9.29  | x | 5.68  | x | 0.098 |
| 0501 348 025           | FM7132-2.0      | STEEL     | -----             | 36              | (48)IN TH | 236.0 | x | 144.2     | x | 2.0 | 9.29  | x | 5.68  | x | 0.079 |
| 0730 105 150           | FM4766TW        | STEEL     | HARDENED          |                 | WASHER    | 46.0  | x | 26.2      | x | 1.0 | 1.81  | x | 1.03  | x | 0.039 |

| REPLACES<br>OEM PT.NO. | FMC<br>PART NO. | MATERIAL   | GROOVE<br>DETAILS | TEETH/<br>TANGS | SIZE MM   |       |   | SIZE INCH |   |     |       |   |       |   |       |
|------------------------|-----------------|------------|-------------------|-----------------|-----------|-------|---|-----------|---|-----|-------|---|-------|---|-------|
| 0750 140 009           | FM2277          | BRONZE     | SUNBURST          | 27              | EXT TH    | 137.4 | x | 90.9      | x | 2.0 | 5.41  | x | 3.58  | x | 0.079 |
| 0750 140 010           | FM2279          | BRONZE     | SUNBURST          | 35              | EXT TH    | 177.5 | x | 109.0     | x | 2.0 | 6.99  | x | 4.29  | x | 0.079 |
| 0750 140 011           | FM3577          | BRONZE     | SUNBURST          | 35              | EXT TH    | 177.0 | x | 109.0     | x | 2.4 | 6.97  | x | 4.29  | x | 0.094 |
| 0750 140 012           | FM3579          | BRONZE     | SUNBURST          | 27              | EXT TH    | 137.4 | x | 90.9      | x | 2.4 | 5.41  | x | 3.58  | x | 0.094 |
| 0750 140 013           | FM3021          | BRONZE     | SUNBURST          | 87              | INT TH    | 306.0 | x | 258.0     | x | 3.0 | 12.05 | x | 10.16 | x | 0.118 |
| 0750 140 028           | FM3575          | PAPER      | 3 PASS            | 35              | INT TH    | 179.0 | x | 103.0     | x | 3.5 | 7.05  | x | 4.05  | x | 0.138 |
| 0750 140 029           | FM4089          | PAPER      | 3 PASS            | 48              | INT TH    | 232.7 | x | 142.0     | x | 4.0 | 9.16  | x | 5.59  | x | 0.157 |
| 0750 140 049           | FM7688MP        | STEEL      | SINEWAVED         | 40              | (41)IN TH | 233.0 | x | 160.2     | x | 2.8 | 9.17  | x | 6.31  | x | 0.11  |
| 0750 140 060           | FM7526MP        | STEEL      | -----             | 4               | EXT LG    | 251.0 | x | 153.6     | x | 4.0 | 9.88  | x | 6.05  | x | 0.157 |
| 0899 312 912           | FM4304MP        | STEEL      | -----             | 45              | INT TH    | 170.0 | x | 132.7     | x | 4.0 | 6.69  | x | 5.22  | x | 0.157 |
| 0899 316 757           | FM3021          | BRONZE     | SUNBURST          | 87              | INT TH    | 306.0 | x | 258.0     | x | 3.0 | 12.05 | x | 10.16 | x | 0.118 |
| 2092 362 096           | FM8868-3.8      | STEEL      | -----             | 50              | EXT TH    | 204.7 | x | 150.4     | x | 3.8 | 8.06  | x | 5.92  | x | 0.15  |
| 2092 362 176           | FM8868-3.0      | STEEL      | -----             | 50              | EXT TH    | 204.7 | x | 150.4     | x | 3.0 | 8.06  | x | 5.92  | x | 0.118 |
| 2093 213 018           | FM7689          | PAPER      | WAFFLE            | 10              | EXT LG    | 211.0 | x | 149.4     | x | 2.5 | 8.31  | x | 5.88  | x | 0.098 |
| 2093 313 060           | FM7692MP        | STEEL      | SINEWAVED         | 47              | (48)IN TH | 198.0 | x | 131.6     | x | 2.8 | 7.8   | x | 5.18  | x | 0.11  |
| 2093 359 051           | FM8332MP        | STEEL      | -----             | 36              | INT TH    | 110.9 | x | 70.7      | x | 1.5 | 4.37  | x | 2.78  | x | 0.059 |
| 2094 213 014           | FM7685          | PAPER      | WAFFLE            | 12              | EXT LG    | 252.7 | x | 180.6     | x | 2.5 | 9.95  | x | 7.11  | x | 0.098 |
| 3205 302 057           | FM8765          | BRONZE     | WAFFLE            | 51              | EXT TH    | 103.7 | x | 77.1      | x | 2.2 | 4.08  | x | 3.04  | x | 0.087 |
| 3205 302 062           | FM8768MP        | STEEL      | -----             | 36              | INT TH    | 97.5  | x | 71.2      | x | 1.4 | 3.84  | x | 2.8   | x | 0.055 |
| 3205 302 066           | FM8768MP        | STEEL      | -----             | 36              | INT TH    | 97.5  | x | 71.2      | x | 1.4 | 3.84  | x | 2.8   | x | 0.055 |
| 3207 302 027           | FM7638MP        | STEEL      | -----             | 27              | INT TH    | 107.2 | x | 78.7      | x | 1.5 | 4.22  | x | 3.1   | x | 0.059 |
| 3207 302 029           | FM7635          | BRONZE     | WAFFLE            | 37              | EXT TH    | 113.8 | x | 85.0      | x | 2.2 | 4.48  | x | 3.35  | x | 0.087 |
| 3209 303 035           | FM7744MP        | STEEL      | -----             | 35              | INT TH    | 128.8 | x | 83.0      | x | 1.5 | 5.07  | x | 3.27  | x | 0.059 |
| 3210 303 015           | FM7741          | BRONZE     | WAFFLE            | 68              | EXT TH    | 137.5 | x | 91.2      | x | 2.1 | 5.41  | x | 3.59  | x | 0.083 |
| 3312 302 008           | FM7740MP        | STEEL      | HARDENED          | 6               | EXT LG    | 146.6 | x | 97.4      | x | 1.7 | 5.77  | x | 3.83  | x | 0.067 |
| 3312 302 009           | FM7737          | BRONZE     | SUNBURST          | 36              | INT TH    | 134.0 | x | 90.3      | x | 2.0 | 5.28  | x | 3.56  | x | 0.079 |
| 4061 310 116           | FM4451          | MOLYBDENUM | SPR/WAG           | 46              | (50)IN TH | 117.5 | x | 62.6      | x | 2.6 | 4.63  | x | 2.46  | x | 0.102 |
| 4061 310 125           | FM4666-2.2      | STEEL      | HARDENED          | 6               | EXT SL    | 130.0 | x | 66.8      | x | 2.2 | 5.12  | x | 2.63  | x | 0.087 |
| 4061 310 255           | FM4451          | MOLYBDENUM | SPR/WAG           | 46              | (50)IN TH | 117.5 | x | 62.6      | x | 2.6 | 4.63  | x | 2.46  | x | 0.102 |
| 4061 310 264           | FM4666-2.2      | STEEL      | HARDENED          | 6               | EXT SL    | 130.0 | x | 66.8      | x | 2.2 | 5.12  | x | 2.63  | x | 0.087 |
| 4061 310 265           | FM4666MP        | STEEL      | HARDENED          | 6               | EXT SL    | 130.0 | x | 66.8      | x | 2.3 | 5.12  | x | 2.63  | x | 0.091 |
| 4061 310 266           | FM4666-2.4      | STEEL      | HARDENED          | 6               | EXT SL    | 130.0 | x | 66.8      | x | 2.4 | 5.12  | x | 2.63  | x | 0.094 |
| 4061 310 267           | FM4666-2.5      | STEEL      | HARDENED          | 6               | EXT SL    | 130.0 | x | 66.8      | x | 2.5 | 5.12  | x | 2.63  | x | 0.098 |
| 4061 313 235           | FM4449          | MOLYBDENUM | SPR/WAG           | 26              | INT TH    | 147.8 | x | 75.4      | x | 3.0 | 5.82  | x | 2.97  | x | 0.118 |
| 4061 316 165           | FM5247          | MOLYBDENUM | SPR/WAG           | 40              | INT TH    | 172.0 | x | 84.1      | x | 3.0 | 6.77  | x | 3.31  | x | 0.118 |
| 4061 316 224           | FM5250-2.9      | STEEL      | HARDENED          | 4               | EXT LG    | 189.8 | x | 92.1      | x | 2.9 | 7.47  | x | 3.63  | x | 0.114 |
| 4061 316 227           | FM5250-3.3      | STEEL      | HARDENED          | 4               | EXT LG    | 189.8 | x | 92.1      | x | 3.3 | 7.47  | x | 3.63  | x | 0.13  |
| 4061 316 240           | FM5250-3.0      | STEEL      | HARDENED          | 4               | EXT LG    | 189.9 | x | 92.1      | x | 3.0 | 7.47  | x | 3.63  | x | 0.118 |
| 4061 316 243           | FM5250-2.9      | STEEL      | HARDENED          | 4               | EXT LG    | 189.8 | x | 92.1      | x | 2.9 | 7.47  | x | 3.63  | x | 0.114 |
| 4061 316 244           | FM5250-3.1      | STEEL      | HARDENED          | 4               | EXT LG    | 189.8 | x | 92.1      | x | 3.1 | 7.47  | x | 3.63  | x | 0.122 |
| 4061 316 245           | FM5250-3.2      | STEEL      | HARDENED          | 4               | EXT LG    | 189.8 | x | 92.1      | x | 3.2 | 7.47  | x | 3.63  | x | 0.126 |
| 4061 316 246           | FM5250-3.3      | STEEL      | HARDENED          | 4               | EXT LG    | 189.8 | x | 92.1      | x | 3.3 | 7.47  | x | 3.63  | x | 0.13  |
| 4112 333 551           | FM3584MP        | STEEL      | -----             | 12              | EXT LG    | 320.0 | x | 268.0     | x | 3.5 | 12.6  | x | 10.55 | x | 0.138 |
| 4128 310 017           | FM4836MP        | STEEL      | -----             | 6               | EXT LG    | 129.8 | x | 89.3      | x | 1.5 | 5.11  | x | 3.52  | x | 0.059 |
| 4131 303 048           | FM8999          | MOLYBDENUM | -----             | 36              | INT TH    | 71.7  | x | 44.8      | x | 1.5 | 2.82  | x | 1.76  | x | 0.059 |
| 4131 303 194           | FM9002MP        | STEEL      | HARDENED          | 4               | EXT LG    | 84.5  | x | 49.7      | x | 1.3 | 3.33  | x | 1.96  | x | 0.051 |
| 4139 219 064           | FM4833          | PAPER      | 2 PASS            | 29              | INT TH    | 117.8 | x | 84.0      | x | 1.9 | 4.64  | x | 3.31  | x | 0.073 |
| 4139 233 014           | FM3963          | PAPER      | 2 PASS            | 10              | EXT LG    | 177.0 | x | 126.0     | x | 3.0 | 6.97  | x | 4.97  | x | 0.117 |

| REPLACES<br>OEM PT.NO. | FMC<br>PART NO. | MATERIAL | GROOVE<br>DETAILS | TEETH/<br>TANGS | SIZE MM   |       |   | SIZE INCH |   |     |       |   |       |   |       |
|------------------------|-----------------|----------|-------------------|-----------------|-----------|-------|---|-----------|---|-----|-------|---|-------|---|-------|
| 4139 233 025           | FM3963          | PAPER    | 2 PASS            | 10              | EXT LG    | 177.0 | x | 126.0     | x | 3.0 | 6.97  | x | 4.97  | x | 0.117 |
| 4139 233 177           | FM3965          | PAPER    | RADIAL            | 43              | INT TH    | 257.0 | x | 212.0     | x | 3.0 | 10.11 | x | 8.34  | x | 0.117 |
| 4139 233 178           | FM4409          | PAPER    | RADIAL            | 46              | INT TH    | 278.0 | x | 228.0     | x | 3.0 | 10.84 | x | 8.98  | x | 0.117 |
| 4139 233 303           | FM3967          | PAPER    | RADIAL            | 46              | INT TH    | 278.0 | x | 228.0     | x | 2.7 | 10.84 | x | 8.98  | x | 0.106 |
| 4139 233 307           | FM3967          | PAPER    | RADIAL            | 46              | INT TH    | 278.0 | x | 228.0     | x | 2.7 | 10.84 | x | 8.98  | x | 0.106 |
| 4139 233 309           | FM3889          | BRONZE   | SPR/RAD           | 48              | INT TH    | 278.0 | x | 238.0     | x | 3.0 | 10.94 | x | 9.37  | x | 0.117 |
| 4139 236 098           | FM3969          | PAPER    | RADIAL            | 18              | INT TH    | 329.0 | x | 285.0     | x | 3.0 | 12.96 | x | 11.24 | x | 0.117 |
| 4139 270 021           | FM3963          | PAPER    | 2 PASS            | 10              | EXT LG    | 177.0 | x | 126.0     | x | 3.0 | 6.97  | x | 4.97  | x | 0.117 |
| 4139 270 025           | FM3963          | PAPER    | 2 PASS            | 10              | EXT LG    | 177.0 | x | 126.0     | x | 3.0 | 6.97  | x | 4.97  | x | 0.117 |
| 4139 270 032           | FM3963          | PAPER    | 2 PASS            | 10              | EXT LG    | 177.0 | x | 126.0     | x | 3.0 | 6.97  | x | 4.97  | x | 0.117 |
| 4139 270 034           | FM3965          | PAPER    | RADIAL            | 43              | INT TH    | 257.0 | x | 212.0     | x | 3.0 | 10.11 | x | 8.34  | x | 0.117 |
| 4139 270 035           | FM3963          | PAPER    | 2 PASS            | 10              | EXT LG    | 177.0 | x | 126.0     | x | 3.0 | 6.97  | x | 4.97  | x | 0.117 |
| 4139 270 036           | FM3965          | PAPER    | RADIAL            | 43              | INT TH    | 257.0 | x | 212.0     | x | 3.0 | 10.11 | x | 8.34  | x | 0.117 |
| 4139 333 009           | FM4488MP        | STEEL    | -----             | 24              | (32)EX TH | 306.0 | x | 237.0     | x | 3.5 | 12.03 | x | 9.3   | x | 0.137 |
| 4139 333 015           | FM3988MP        | STEEL    | HOLES             | 24              | (32)EX TH | 306.0 | x | 237.0     | x | 2.0 | 12.03 | x | 9.3   | x | 0.079 |
| 4139 333 036           | FM3972MP        | STEEL    | -----             | 32              | INT TH    | 163.0 | x | 94.0      | x | 2.0 | 6.41  | x | 3.69  | x | 0.079 |
| 4139 333 172           | FM3976MP        | STEEL    | -----             | 34              | (45)EX TH | 281.0 | x | 221.0     | x | 2.0 | 11.05 | x | 8.7   | x | 0.079 |
| 4139 333 187           | FM3998MP        | STEEL    | "M"               | 45              | EXT TH    | 281.0 | x | 221.0     | x | 3.0 | 11.05 | x | 8.7   | x | 0.118 |
| 4139 333 263           | FM3992MP        | STEEL    | HOLES             | 24              | (32)EX TH | 306.0 | x | 237.0     | x | 3.0 | 12.03 | x | 9.3   | x | 0.118 |
| 4139 333 281           | FM3980MP        | STEEL    | -----             | 24              | (32)EX TH | 281.0 | x | 221.0     | x | 3.0 | 11.05 | x | 8.7   | x | 0.118 |
| 4139 333 335           | FM3892MP        | STEEL    | 8 HOLES           | 24              | (32)EX TH | 306.0 | x | 247.0     | x | 2.0 | 12.03 | x | 9.72  | x | 0.079 |
| 4139 333 373           | FM3998MP        | STEEL    | "M"               | 45              | EXT TH    | 281.0 | x | 221.0     | x | 3.0 | 11.05 | x | 8.7   | x | 0.118 |
| 4139 333 437           | FM3994MP        | STEEL    | "S"               | 45              | EXT TH    | 282.0 | x | 221.0     | x | 3.0 | 11.1  | x | 8.7   | x | 0.118 |
| 4139 333 480           | FM3982MP        | STEEL    | -----             | 24              | (32)EX TH | 306.0 | x | 237.0     | x | 2.0 | 12.03 | x | 9.3   | x | 0.079 |
| 4139 333 745           | FM3990MP        | STEEL    | HOLES             | 24              | (32)EX TH | 306.0 | x | 237.0     | x | 2.5 | 12.03 | x | 9.3   | x | 0.098 |
| 4139 333 759           | FM3978MP        | STEEL    | -----             | 34              | (45)EX TH | 281.0 | x | 221.0     | x | 2.5 | 11.05 | x | 8.7   | x | 0.098 |
| 4139 333 765           | FM3974MP        | STEEL    | -----             | 32              | INT TH    | 163.0 | x | 94.0      | x | 2.5 | 6.41  | x | 3.69  | x | 0.098 |
| 4139 333 766           | FM3986MP        | STEEL    | -----             | 24              | (32)EX TH | 306.0 | x | 237.0     | x | 3.0 | 12.03 | x | 9.3   | x | 0.118 |
| 4139 333 768           | FM3894MP        | STEEL    | 8 HOLES           | 24              | (32)EX TH | 306.0 | x | 247.0     | x | 2.5 | 12.03 | x | 9.72  | x | 0.098 |
| 4139 334 002           | FM4482MP        | STEEL    | -----             | 12              | EXT LG    | 360.0 | x | 301.0     | x | 2.0 | 14.16 | x | 11.85 | x | 0.079 |
| 4139 334 004           | FM4482MP        | STEEL    | -----             | 12              | EXT LG    | 360.0 | x | 301.0     | x | 2.0 | 14.16 | x | 11.85 | x | 0.079 |
| 4139 334 005           | FM3804MP        | STEEL    | -----             | 12              | EXT LG    | 360.0 | x | 301.0     | x | 4.0 | 14.16 | x | 11.85 | x | 0.157 |
| 4139 334 005-4.5       | FM8792MP        | STEEL    | -----             | 12              | EXT LG    | 360.0 | x | 301.0     | x | 4.5 | 14.16 | x | 11.85 | x | 0.177 |
| 4139 334 006           | FM4000MP        | STEEL    | -----             | 12              | EXT LG    | 360.0 | x | 301.0     | x | 3.5 | 14.16 | x | 11.85 | x | 0.137 |
| 4139 373 029           | FM3982MP        | STEEL    | -----             | 24              | (32)EX TH | 306.0 | x | 237.0     | x | 2.0 | 12.03 | x | 9.3   | x | 0.079 |
| 4143 251 002           | FM4933          | BRONZE   | WAF/WAG           | 45              | INT TH    | 187.0 | x | 132.6     | x | 3.0 | 7.36  | x | 5.22  | x | 0.118 |
| 4143 351 011           | FM7038MP        | STEEL    | HARD/BLACK        | 64              | EXT TH    | 196.4 | x | 140.0     | x | 2.9 | 7.73  | x | 5.51  | x | 0.114 |
| 4143 351 013           | FM7038-3.5      | STEEL    | HARD/BLACK        | 64              | EXT TH    | 196.4 | x | 140.0     | x | 3.5 | 7.73  | x | 5.51  | x | 0.138 |
| 4143 351 025           | FM7038MP        | STEEL    | HARD/BLACK        | 64              | EXT TH    | 196.4 | x | 140.0     | x | 2.9 | 7.73  | x | 5.51  | x | 0.114 |
| 4143 352 058           | FM8188MP        | STEEL    | HARDENED          | 45              | EXT TH    | 111.2 | x | 84.2      | x | 1.4 | 4.38  | x | 3.31  | x | 0.055 |
| 4149 333 009           | FM4488MP        | STEEL    | -----             | 24              | (32)EX TH | 306.0 | x | 237.0     | x | 3.5 | 12.03 | x | 9.3   | x | 0.137 |
| 4149 333 760           | FM4488MP        | STEEL    | -----             | 24              | (32)EX TH | 306.0 | x | 237.0     | x | 3.5 | 12.03 | x | 9.3   | x | 0.137 |
| 4149 370 001           | FM4576MP        | STEEL    | -----             | 34              | (45)EX TH | 281.0 | x | 221.0     | x | 3.0 | 11.05 | x | 8.7   | x | 0.118 |
| 4149 370 004           | FM4574MP        | STEEL    | -----             | 34              | (45)EX TH | 281.0 | x | 221.0     | x | 2.5 | 11.05 | x | 8.7   | x | 0.098 |
| 4149 370 005           | FM4572MP        | STEEL    | -----             | 34              | (45)EX TH | 281.0 | x | 221.0     | x | 2.0 | 11.05 | x | 8.7   | x | 0.079 |
| 4166 236 098           | FM3969          | PAPER    | RADIAL            | 18              | INT TH    | 329.0 | x | 285.0     | x | 3.0 | 12.96 | x | 11.24 | x | 0.117 |
| 4166 236 112           | FM3969          | PAPER    | RADIAL            | 18              | INT TH    | 329.0 | x | 285.0     | x | 3.0 | 12.96 | x | 11.24 | x | 0.117 |

| REPLACES<br>OEM PT.NO. | FMC<br>PART NO. | MATERIAL | GROOVE<br>DETAILS | TEETH/<br>TANGS |           | SIZE MM |   |       | SIZE INCH |     |       |   |       |   |       |
|------------------------|-----------------|----------|-------------------|-----------------|-----------|---------|---|-------|-----------|-----|-------|---|-------|---|-------|
| 4166 236 129           | FM3969          | PAPER    | RADIAL            | 18              | INT TH    | 329.0   | x | 285.0 | x         | 3.0 | 12.96 | x | 11.24 | x | 0.117 |
| 4166 236 134           | FM3969          | PAPER    | RADIAL            | 18              | INT TH    | 329.0   | x | 285.0 | x         | 3.0 | 12.96 | x | 11.24 | x | 0.117 |
| 4166 238 042           | FM4871          | AFP      | RADIAL            | 36              | INT LG    | 390.0   | x | 345.0 | x         | 3.1 | 15.35 | x | 13.58 | x | 0.122 |
| 4166 238 042           | FM5277          | PAPER    | RADIAL            | 36              | INT LG    | 390.0   | x | 345.0 | x         | 3.1 | 15.35 | x | 13.58 | x | 0.122 |
| 4166 238 047           | FM4871          | AFP      | RADIAL            | 36              | INT LG    | 390.0   | x | 345.0 | x         | 3.1 | 15.35 | x | 13.58 | x | 0.122 |
| 4166 238 047           | FM5277          | PAPER    | RADIAL            | 36              | INT LG    | 390.0   | x | 345.0 | x         | 3.1 | 15.35 | x | 13.58 | x | 0.122 |
| 4166 263 114           | FM3801          | PAPER    | RADIAL            | 30              | INT LG    | 329.0   | x | 285.0 | x         | 3.0 | 12.96 | x | 11.24 | x | 0.117 |
| 4166 338 202           | FM5304-3.0      | STEEL    | -----             | 8               | EXT LG    | 417.6   | x | 354.0 | x         | 3.0 | 16.44 | x | 14.33 | x | 0.118 |
| 4166 338 206           | FM5304-3.5      | STEEL    | -----             | 8               | EXT LG    | 417.6   | x | 354.0 | x         | 3.5 | 16.44 | x | 14.33 | x | 0.138 |
| 4462 305 075           | FM3946MP        | STEEL    | -----             | 67              | (70)EX TH | 191.0   | x | 130.0 | x         | 3.0 | 7.52  | x | 5.12  | x | 0.118 |
| 4462 305 079           | FM4844MP        | STEEL    | -----             | 67              | (70)EX TH | 191.0   | x | 130.0 | x         | 2.0 | 7.52  | x | 5.12  | x | 0.079 |
| 4462 305 080           | FM3948MP        | STEEL    | -----             | 67              | (70)EX TH | 191.0   | x | 130.0 | x         | 2.5 | 7.52  | x | 5.12  | x | 0.098 |
| 4462 305 081           | FM3946MP        | STEEL    | -----             | 67              | (70)EX TH | 191.0   | x | 130.0 | x         | 3.0 | 7.52  | x | 5.12  | x | 0.118 |
| 4462 305 084           | FM3870MP        | STEEL    | -----             | 87              | (90)EX TH | 189.1   | x | 130.6 | x         | 2.5 | 7.44  | x | 5.14  | x | 0.098 |
| 4472 209 002           | FM4089          | PAPER    | 3 PASS            | 48              | INT TH    | 232.7   | x | 142.0 | x         | 4.0 | 9.16  | x | 5.59  | x | 0.157 |
| 4472 320 103           | FM6896MP        | STEEL    | -----             | 81              | EXT TH    | 243.6   | x | 152.1 | x         | 2.0 | 9.59  | x | 5.99  | x | 0.079 |
| 4472 320 104           | FM4686MP        | STEEL    | -----             | 81              | EXT TH    | 243.6   | x | 152.1 | x         | 2.5 | 9.59  | x | 5.99  | x | 0.098 |
| 4472 320 105           | FM6120-3.0      | STEEL    | -----             | 81              | EXT TH    | 243.5   | x | 153.0 | x         | 3.0 | 9.59  | x | 6.02  | x | 0.118 |
| 4472 347 017           | FM8432-2.0      | STEEL    | -----             | 31              | (40)IN TH | 208.0   | x | 119.0 | x         | 2.0 | 8.19  | x | 4.69  | x | 0.079 |
| 4472 347 018           | FM8432-2.5      | STEEL    | -----             | 31              | (40)IN TH | 208.0   | x | 119.0 | x         | 2.5 | 8.19  | x | 4.69  | x | 0.098 |
| 4472 347 019           | FM8432-3.0      | STEEL    | -----             | 31              | (40)IN TH | 208.0   | x | 119.0 | x         | 3.0 | 8.19  | x | 4.69  | x | 0.118 |
| 4472 348 023           | FM7132-2.5      | STEEL    | -----             | 36              | (48)IN TH | 236.0   | x | 144.2 | x         | 2.5 | 9.29  | x | 5.68  | x | 0.098 |
| 4472 348 024           | FM7132-3.0      | STEEL    | -----             | 36              | (48)IN TH | 236.0   | x | 144.2 | x         | 3.0 | 9.29  | x | 5.68  | x | 0.118 |
| 4472 348 025           | FM7132-2.0      | STEEL    | -----             | 36              | (48)IN TH | 236.0   | x | 144.2 | x         | 2.0 | 9.29  | x | 5.68  | x | 0.079 |
| 4474 205 001           | FM2811          | PAPER    | 4 PASS            | 34              | INT TH    | 277.0   | x | 167.0 | x         | 4.5 | 10.91 | x | 6.57  | x | 0.177 |
| 4474 252 008           | FM4183          | PAPER    | WAF/WAG           | 64              | INT TH    | 345.0   | x | 252.1 | x         | 4.7 | 13.58 | x | 9.93  | x | 0.185 |
| 4474 252 023           | FM4183          | PAPER    | WAF/WAG           | 64              | INT TH    | 345.0   | x | 252.1 | x         | 4.7 | 13.58 | x | 9.93  | x | 0.185 |
| 4474 252 033           | FM4183          | PAPER    | WAF/WAG           | 64              | INT TH    | 345.0   | x | 252.1 | x         | 4.7 | 13.58 | x | 9.93  | x | 0.185 |
| 4474 304 048           | FM3608MP        | STEEL    | -----             | 88              | (91)EX TH | 293.0   | x | 185.0 | x         | 4.5 | 11.54 | x | 7.28  | x | 0.177 |
| 4474 304 049           | FM3606MP        | STEEL    | -----             | 88              | (91)EX TH | 293.0   | x | 185.0 | x         | 4.0 | 11.54 | x | 7.28  | x | 0.157 |
| 4474 304 064           | FM3606MP        | STEEL    | -----             | 88              | (91)EX TH | 293.0   | x | 185.0 | x         | 4.0 | 11.54 | x | 7.28  | x | 0.157 |
| 4474 304 065           | FM3608MP        | STEEL    | -----             | 88              | (91)EX TH | 293.0   | x | 185.0 | x         | 4.5 | 11.54 | x | 7.28  | x | 0.177 |
| 4474 305 202           | FM3606MP        | STEEL    | -----             | 88              | (91)EX TH | 293.0   | x | 185.0 | x         | 4.0 | 11.54 | x | 7.28  | x | 0.157 |
| 4474 305 203           | FM3608MP        | STEEL    | -----             | 88              | (91)EX TH | 293.0   | x | 185.0 | x         | 4.5 | 11.54 | x | 7.28  | x | 0.177 |
| 4474 308 082           | FM3610MP        | STEEL    | -----             | 91              | EXT TH    | 355.0   | x | 217.0 | x         | 4.5 | 13.98 | x | 8.54  | x | 0.177 |
| 4474 308 083           | FM3612MP        | STEEL    | -----             | 91              | EXT TH    | 355.0   | x | 217.0 | x         | 5.0 | 13.98 | x | 8.54  | x | 0.197 |
| 4474 308 084           | FM3614MP        | STEEL    | -----             | 91              | EXT TH    | 355.0   | x | 217.0 | x         | 5.5 | 13.98 | x | 8.54  | x | 0.217 |
| 4474 309 037           | FM3610MP        | STEEL    | -----             | 91              | EXT TH    | 355.0   | x | 217.0 | x         | 4.5 | 13.98 | x | 8.54  | x | 0.177 |
| 4474 309 038           | FM3612MP        | STEEL    | -----             | 91              | EXT TH    | 355.0   | x | 217.0 | x         | 5.0 | 13.98 | x | 8.54  | x | 0.197 |
| 4474 309 039           | FM3614MP        | STEEL    | -----             | 91              | EXT TH    | 355.0   | x | 217.0 | x         | 5.5 | 13.98 | x | 8.54  | x | 0.217 |
| 4474 322 140           | FM6417          | BRONZE   | WAF/WAG           | 64              | INT TH    | 345.0   | x | 252.0 | x         | 3.8 | 13.58 | x | 9.92  | x | 0.15  |
| 4474 352 052           | FM4186MP        | STEEL    | -----             | 20              | EXT LG    | 372.5   | x | 262.5 | x         | 4.0 | 14.67 | x | 10.33 | x | 0.157 |
| 4474 352 121           | FM5572MP        | STEEL    | -----             | 20              | EXT LG    | 372.5   | x | 262.5 | x         | 2.0 | 14.67 | x | 10.33 | x | 0.079 |
| 4474 352 157           | FM6454MP        | STEEL    | HARDENED          | 20              | EXT LG    | 374.0   | x | 262.0 | x         | 2.4 | 14.72 | x | 10.31 | x | 0.094 |
| 4474 352 160           | FM4186MP        | STEEL    | -----             | 20              | EXT LG    | 372.5   | x | 262.5 | x         | 4.0 | 14.67 | x | 10.33 | x | 0.157 |
| 4474 352 002           | FM8684MP        | STEEL    | -----             | 20              | EXT LG    | 473.0   | x | 322.0 | x         | 4.0 | 18.62 | x | 12.68 | x | 0.157 |
| 4474 355 023           | FM9264-4.0      | STEEL    | HARDEDED          | 20              | EXT LG    | 479.0   | x | 322.0 | x         | 4.0 | 18.86 | x | 12.68 | x | 0.157 |
| 4474 355 024           | FM9264-2.6      | STEEL    | HARDEDED          | 20              | EXT LG    | 479.0   | x | 322.0 | x         | 2.6 | 18.86 | x | 12.68 | x | 0.102 |



| REPLACES<br>OEM PT.NO. | FMC<br>PART NO. | MATERIAL   | GROOVE<br>DETAILS | TEETH/<br>TANGS | SIZE MM |       |   | SIZE INCH |   |     |       |   |       |   |       |
|------------------------|-----------------|------------|-------------------|-----------------|---------|-------|---|-----------|---|-----|-------|---|-------|---|-------|
| 4474 355 025           | FM9264-3.2      | STEEL      | HARDED            | 20              | EXT LG  | 479.0 | x | 322.0     | x | 3.2 | 18.86 | x | 12.68 | x | 0.126 |
| 4474 355 026           | FM9264-3.0      | STEEL      | HARDED            | 20              | EXT LG  | 479.0 | x | 322.0     | x | 3.0 | 18.86 | x | 12.68 | x | 0.118 |
| 4474 355 027           | FM9264-2.8      | STEEL      | HARDED            | 20              | EXT LG  | 479.0 | x | 322.0     | x | 2.8 | 18.86 | x | 12.68 | x | 0.11  |
| 4474 355 053           | FM9264-1.7      | STEEL      | -----             | 20              | EXT LG  | 479.0 | x | 322.0     | x | 1.7 | 18.86 | x | 12.68 | x | 0.067 |
| 4474 355 055           | FM9264-0.7      | STEEL      | -----             | 20              | EXT LG  | 479.0 | x | 322.0     | x | 0.7 | 18.86 | x | 12.68 | x | 0.028 |
| 4474 355 085           | FM9264-2.7      | STEEL      | HARDENED          | 20              | EXT LG  | 479.0 | x | 322.0     | x | 2.7 | 18.86 | x | 12.68 | x | 0.106 |
| 4474 355 092           | FM9264-1.1      | STEEL      | -----             | 20              | EXT LG  | 479.0 | x | 322.0     | x | 1.1 | 18.86 | x | 12.68 | x | 0.043 |
| 4474 355 093           | FM9264-1.4      | STEEL      | -----             | 20              | EXT LG  | 479.0 | x | 322.0     | x | 1.4 | 18.86 | x | 12.68 | x | 0.55  |
| 4474 355 094           | FM9264-2.0      | STEEL      | -----             | 20              | EXT LG  | 479.0 | x | 322.0     | x | 2.0 | 18.86 | x | 12.68 | x | 0.079 |
| 4474 355 095           | FM9264-2.3      | STEEL      | -----             | 20              | EXT LG  | 479.0 | x | 322.0     | x | 2.3 | 18.86 | x | 12.68 | x | 0.091 |
| 4475 219 001           | FM8937          | BRONZE     | SPR/RAD           | 34              | INT TH  | 141.5 | x | 99.0      | x | 4.0 | 5.57  | x | 3.9   | x | 0.157 |
| 4475 319 012           | FM9042MP        | STEEL      | HARDENED          | 8               | EXT LG  | 160.0 | x | 109.5     | x | 4.0 | 6.3   | x | 4.31  | x | 0.157 |
| 4475 308 017           | FM6120-4.0      | STEEL      | -----             | 81              | EXT TH  | 243.5 | x | 153.0     | x | 4.0 | 9.59  | x | 6.02  | x | 0.157 |
| 4475 336 181           | FM7250-3.0      | STEEL      | -----             | 5               | EXT LG  | 210.6 | x | 158.5     | x | 3.0 | 8.29  | x | 6.24  | x | 0.118 |
| 4475 336 191           | FM7250-2.0      | STEEL      | -----             | 5               | EXT LG  | 210.6 | x | 158.5     | x | 2.0 | 8.29  | x | 6.24  | x | 0.079 |
| 4475 336 192           | FM7250MP        | STEEL      | -----             | 5               | EXT LG  | 210.6 | x | 158.5     | x | 2.5 | 8.29  | x | 6.24  | x | 0.098 |
| 4481 313 006           | FM7126-2.9      | STEEL      | HARDENED          | 4               | EXT LG  | 164.8 | x | 82.4      | x | 2.9 | 6.49  | x | 4.24  | x | 0.114 |
| 4481 313 031           | FM7126-2.8      | STEEL      | HARDENED          | 4               | EXT LG  | 164.8 | x | 82.4      | x | 2.8 | 6.49  | x | 4.24  | x | 0.11  |
| 4481 313 032           | FM7126-2.9      | STEEL      | HARDENED          | 4               | EXT LG  | 164.8 | x | 82.4      | x | 2.9 | 6.49  | x | 4.24  | x | 0.114 |
| 4481 313 033           | FM7126-3.0      | STEEL      | HARDENED          | 4               | EXT LG  | 164.8 | x | 82.4      | x | 3.0 | 6.49  | x | 4.24  | x | 0.118 |
| 4481 313 034           | FM7126-3.1      | STEEL      | HARDENED          | 4               | EXT LG  | 164.8 | x | 82.4      | x | 3.1 | 6.49  | x | 4.24  | x | 0.122 |
| 4481 345 066           | FM7839          | MOLYBDENUM | -----             | 26              | INT TH  | 84.7  | x | 51.0      | x | 1.5 | 3.33  | x | 2.0   | x | 0.059 |
| 4481 345 067           | FM7841          | MOLYBDENUM | -----             | 26              | INT TH  | 84.7  | x | 51.0      | x | 3.0 | 3.33  | x | 2.0   | x | 0.118 |
| 4481 345 081           | FM7744-1.5      | STEEL      | HARDENED          | 4               | EXT LG  | 102.0 | x | 60.0      | x | 1.5 | 4.02  | x | 2.36  | x | 0.059 |
| 4481 345 082           | FM7744-1.4      | STEEL      | HARDENED          | 4               | EXT LG  | 102.0 | x | 60.0      | x | 1.4 | 4.02  | x | 2.36  | x | 0.055 |
| 4481 371 064           | FM8340-4.0      | STEEL      | HARDENED          | 16              | EXT LG  | 171.6 | x | 105       | x | 4.0 | 6.76  | x | 4.13  | x | 0.157 |
| 4481 371 074           | FM8340MP        | STEEL      | HARDENED          | 16              | EXT SL  | 171.6 | x | 105       | x | 1.2 | 6.76  | x | 4.13  | x | 0.047 |
| 4481 371 077           | FM8337          | MOLYBDENUM | SPR/WAG           | 44              | INT TH  | 154.5 | x | 86.3      | x | 2.7 | 6.08  | x | 3.4   | x | 0.104 |
| 4481 371 104           | FM7667          | MOLYBDENUM | -----             | 31              | INT TH  | 102.8 | x | 61.1      | x | 1.6 | 4.05  | x | 2.41  | x | 0.061 |
| 4481 371 106           | FM7670-1.8      | STEEL      | HARDENED          | 2               | EXT LG  | 120.0 | x | 65.6      | x | 1.8 | 4.72  | x | 2.57  | x | 0.071 |
| 4481 371 107           | FM7670-1.9      | STEEL      | HARDENED          | 2               | EXT LG  | 120.0 | x | 65.6      | x | 1.9 | 4.72  | x | 2.57  | x | 0.075 |
| 4481 371 108           | FM7670-2.0      | STEEL      | HARDENED          | 2               | EXT LG  | 120.0 | x | 65.6      | x | 2.0 | 4.72  | x | 2.57  | x | 0.079 |
| 4616 208 002           | FM2943          | BRONZE     | SPR/RAD           | 42              | EXT TH  | 212.5 | x | 154.5     | x | 2.5 | 8.37  | x | 6.08  | x | 0.098 |
| 4616 208 003           | FM2943          | BRONZE     | SPR/RAD           | 42              | EXT TH  | 212.5 | x | 154.5     | x | 2.5 | 8.37  | x | 6.08  | x | 0.098 |
| 4616 223 003           | FM5367          | BRONZE     | SPR/RAD           | 75              | INT TH  | 373.2 | x | 295.5     | x | 3.3 | 14.69 | x | 11.63 | x | 0.128 |
| 4616 308 035           | FM2962MP        | STEEL      | -----             | 37              | INT TH  | 204.6 | x | 143.8     | x | 2.0 | 8.06  | x | 5.66  | x | 0.079 |
| 4616 323 017           | FM5370MP        | STEEL      | -----             | 14              | EXT SL  | 399.5 | x | 310.3     | x | 3.0 | 15.73 | x | 12.22 | x | 0.118 |
| 4620 233 028           | FM3021          | BRONZE     | SUNBURST          | 87              | INT TH  | 306.0 | x | 258.0     | x | 3.0 | 12.05 | x | 10.16 | x | 0.118 |
| 4620 233 055           | FM3021          | BRONZE     | SUNBURST          | 87              | INT TH  | 306.0 | x | 258.0     | x | 3.0 | 12.05 | x | 10.16 | x | 0.118 |
| 4620 333 152           | FM3024MP        | STEEL      | -----             | 12              | EXT LG  | 317.7 | x | 268.0     | x | 3.0 | 12.51 | x | 10.55 | x | 0.118 |
| 4620 333 184           | FM3024MP        | STEEL      | -----             | 12              | EXT LG  | 317.7 | x | 268.0     | x | 3.0 | 12.51 | x | 10.55 | x | 0.118 |
| 4620 333 213           | FM3586MP        | STEEL      | -----             | 12              | EXT LG  | 320.0 | x | 268.0     | x | 2.5 | 12.6  | x | 10.55 | x | 0.098 |
| 4627 333 190           | FM6648MP        | STEEL      | HARDENED          | 10              | EXT SL  | 212.4 | x | 164.2     | x | 1.8 | 8.36  | x | 6.46  | x | 0.069 |
| 4642 208 034           | FM2277          | BRONZE     | SUNBURST          | 27              | EXT TH  | 137.4 | x | 90.9      | x | 2.0 | 5.41  | x | 3.58  | x | 0.079 |
| 4642 308 096           | FM3594MP        | STEEL      | -----             | 29              | INT TH  | 131.1 | x | 85.1      | x | 2.0 | 5.16  | x | 3.35  | x | 0.079 |
| 4642 308 107           | FM3596MP        | STEEL      | -----             | 29              | INT TH  | 131.1 | x | 85.1      | x | 2.5 | 5.16  | x | 3.35  | x | 0.098 |
| 4642 308 330           | FM3592MP        | STEEL      | -----             | 29              | INT TH  | 131.1 | x | 85.1      | x | 1.5 | 5.16  | x | 3.35  | x | 0.059 |
| 4642 308 331           | FM3596MP        | STEEL      | -----             | 29              | INT TH  | 131.1 | x | 85.1      | x | 2.5 | 5.16  | x | 3.35  | x | 0.098 |
| 4642 308 332           | FM3594MP        | STEEL      | -----             | 29              | INT TH  | 131.1 | x | 85.1      | x | 2.0 | 5.16  | x | 3.35  | x | 0.079 |

| REPLACES<br>OEM PT.NO. | FMC<br>PART NO. | MATERIAL  | GROOVE<br>DETAILS | TEETH/<br>TANGS | SIZE MM   |       |   | SIZE INCH |   |      |       |   |       |   |       |
|------------------------|-----------------|-----------|-------------------|-----------------|-----------|-------|---|-----------|---|------|-------|---|-------|---|-------|
| 4644 208 013           | FM3602MP        | STEEL     | -----             | 35              | INT TH    | 170.9 | x | 102.9     | x | 2.0  | 6.73  | x | 4.05  | x | 0.079 |
| 4644 208 072           | FM2279          | BRONZE    | SUNBURST          | 35              | EXT TH    | 177.5 | x | 109.0     | x | 2.0  | 6.99  | x | 4.29  | x | 0.079 |
| 4644 308 054           | FM3602MP        | STEEL     | -----             | 35              | INT TH    | 170.9 | x | 102.9     | x | 2.0  | 6.73  | x | 4.05  | x | 0.079 |
| 4644 308 071           | FM7500MP        | END PLATE | STEPPED           | 35              | EXT TH    | 177.3 | x | 109.4     | x | 10.9 | 6.98  | x | 4.31  | x | 0.429 |
| 4644 308 099           | FM3604MP        | STEEL     | -----             | 35              | INT TH    | 170.9 | x | 102.9     | x | 2.5  | 6.73  | x | 4.05  | x | 0.098 |
| 4644 308 328           | FM3600MP        | STEEL     | -----             | 35              | INT TH    | 170.9 | x | 102.9     | x | 1.5  | 6.73  | x | 4.05  | x | 0.059 |
| 4644 308 329           | FM3602MP        | STEEL     | -----             | 35              | INT TH    | 170.9 | x | 102.9     | x | 2.0  | 6.73  | x | 4.05  | x | 0.079 |
| 4644 308 330           | FM3604MP        | STEEL     | -----             | 35              | INT TH    | 170.9 | x | 102.9     | x | 2.5  | 6.73  | x | 4.05  | x | 0.098 |
| 4644 308 365           | FM6088MP        | STEEL     | -----             | 35              | INT TH    | 170.9 | x | 102.9     | x | 3.0  | 6.73  | x | 4.05  | x | 0.118 |
| 4645 251 004           | FM4647          | BRONZE    | SPR/RAD           | 34              | INT TH    | 100.0 | x | 68.2      | x | 1.6  | 3.94  | x | 2.69  | x | 0.061 |
| 4645 251 005           | FM4643          | BRONZE    | SPR/RAD           | 24              | INT TH    | 143.0 | x | 109.8     | x | 1.6  | 5.63  | x | 4.32  | x | 0.061 |
| 4645 251 021           | FM4647          | BRONZE    | SPR/RAD           | 34              | INT TH    | 100.0 | x | 68.2      | x | 1.6  | 3.94  | x | 2.69  | x | 0.061 |
| 4645 251 022           | FM4643          | BRONZE    | SPR/RAD           | 24              | INT TH    | 143.0 | x | 109.8     | x | 1.6  | 5.63  | x | 4.32  | x | 0.061 |
| 4645 351 020           | FM4650MP        | STEEL     | -----             | 24              | EXT TH    | 108.2 | x | 76.2      | x | 1.2  | 4.26  | x | 3.0   | x | 0.045 |
| 4645 351 023           | FM4646MP        | STEEL     | -----             | 12              | EXT TH    | 156.0 | x | 119.2     | x | 1.2  | 6.14  | x | 4.69  | x | 0.045 |
| 4646 323 017           | FM5370MP        | STEEL     | -----             | 14              | EXT SL    | 399.5 | x | 310.3     | x | 3.0  | 15.73 | x | 12.22 | x | 0.118 |
| 4646 351 099           | FM4282MP        | STEEL     | -----             | 45              | INT TH    | 185.0 | x | 132.7     | x | 2.5  | 7.28  | x | 5.22  | x | 0.098 |
| 4646 351 100           | FM4284MP        | STEEL     | -----             | 45              | INT TH    | 185.0 | x | 132.7     | x | 3.0  | 7.28  | x | 5.22  | x | 0.118 |
| 4646 351 101           | FM4286MP        | STEEL     | -----             | 45              | INT TH    | 185.0 | x | 132.7     | x | 3.5  | 7.28  | x | 5.22  | x | 0.138 |
| 4646 351 162           | FM4288MP        | STEEL     | -----             | 45              | INT TH    | 185.0 | x | 132.7     | x | 4.0  | 7.28  | x | 5.22  | x | 0.157 |
| 4646 351 171           | FM4282MP        | STEEL     | -----             | 45              | INT TH    | 185.0 | x | 132.7     | x | 2.5  | 7.28  | x | 5.22  | x | 0.098 |
| 4646 351 172           | FM4284MP        | STEEL     | -----             | 45              | INT TH    | 185.0 | x | 132.7     | x | 3.0  | 7.28  | x | 5.22  | x | 0.118 |
| 4646 351 173           | FM4286MP        | STEEL     | -----             | 45              | INT TH    | 185.0 | x | 132.7     | x | 3.5  | 7.28  | x | 5.22  | x | 0.138 |
| 4646 351 174           | FM4288MP        | STEEL     | -----             | 45              | INT TH    | 185.0 | x | 132.7     | x | 4.0  | 7.28  | x | 5.22  | x | 0.157 |
| 4646 351 181           | FM4302MP        | STEEL     | -----             | 45              | INT TH    | 170.0 | x | 132.7     | x | 3.5  | 6.69  | x | 5.22  | x | 0.138 |
| 4646 351 182           | FM4300MP        | STEEL     | -----             | 45              | INT TH    | 170.0 | x | 132.7     | x | 3.0  | 6.69  | x | 5.22  | x | 0.118 |
| 4646 351 183           | FM4298MP        | STEEL     | -----             | 45              | INT TH    | 170.0 | x | 132.7     | x | 2.5  | 6.69  | x | 5.22  | x | 0.098 |
| 4646 351 184           | FM4296MP        | STEEL     | -----             | 45              | INT TH    | 170.0 | x | 132.7     | x | 2.0  | 6.69  | x | 5.22  | x | 0.077 |
| 4646 351 212           | FM4302MP        | STEEL     | -----             | 45              | INT TH    | 170.0 | x | 132.7     | x | 3.5  | 6.69  | x | 5.22  | x | 0.138 |
| 4646 351 213           | FM4300MP        | STEEL     | -----             | 45              | INT TH    | 170.0 | x | 132.7     | x | 3.0  | 6.69  | x | 5.22  | x | 0.118 |
| 4646 351 214           | FM4298MP        | STEEL     | -----             | 45              | INT TH    | 170.0 | x | 132.7     | x | 2.5  | 6.69  | x | 5.22  | x | 0.098 |
| 4646 351 215           | FM4296MP        | STEEL     | -----             | 45              | INT TH    | 170.0 | x | 132.7     | x | 2.0  | 6.69  | x | 5.22  | x | 0.077 |
| 4646 351 225           | FM4280MP        | STEEL     | -----             | 45              | INT TH    | 185.0 | x | 132.7     | x | 2.0  | 7.28  | x | 5.22  | x | 0.077 |
| 4646 351 261           | FM4304MP        | STEEL     | -----             | 45              | INT TH    | 170.0 | x | 132.7     | x | 4.0  | 6.69  | x | 5.22  | x | 0.157 |
| 4646 351 284           | FM4282MP        | STEEL     | -----             | 45              | INT TH    | 185.0 | x | 132.7     | x | 2.5  | 7.28  | x | 5.22  | x | 0.098 |
| 4646 351 285           | FM4284MP        | STEEL     | -----             | 45              | INT TH    | 185.0 | x | 132.7     | x | 3.0  | 7.28  | x | 5.22  | x | 0.118 |
| 4646 351 286           | FM4286MP        | STEEL     | -----             | 45              | INT TH    | 185.0 | x | 132.7     | x | 3.5  | 7.28  | x | 5.22  | x | 0.138 |
| 4646 351 287           | FM4288MP        | STEEL     | -----             | 45              | INT TH    | 185.0 | x | 132.7     | x | 4.0  | 7.28  | x | 5.22  | x | 0.157 |
| 5838 300 313           | FM5207          | PAPER     | WAFFLE            | 28              | INT TH    | 223.0 | x | 56.0      | x | 4.4  | 8.78  | x | 2.2   | x | 0.173 |
| 6002 204 363           | FM8799          | CARBON PA | 2 PASS            | 38              | INT TH    | 113.0 | x | 77.1      | x | 1.5  | 4.45  | x | 3.04  | x | 0.059 |
| 6002 305 683           | FM8802MP        | STEEL     | -----             | 29              | EXT TH    | 119.5 | x | 88.8      | x | 1.0  | 4.7   | x | 3.5   | x | 0.039 |
| ?                      | FM3504MP        | STEEL     |                   | 73              | (91)EX TH | 293.0 | x | 185.0     | x | 4.0  | 11.54 | x | 7.28  | x | 0.157 |
| ?                      | FM4237          | PAPER     | 3 PASS            | 56              | INT TH    | 321.0 | x | 275.7     | x | 3.1  | 12.64 | x | 10.85 | x | 0.122 |
| ?                      | FM4240MP        | STEEL     | -----             | 12              | EXT LG    | 341.8 | x | 287.9     | x | 3.0  | 13.46 | x | 11.33 | x | 0.118 |
| ?                      | FM7463          | BRONZE    | SPR/RAD           | 18              | INT TH    | 393.0 | x | 350.8     | x | 3.5  | 15.47 | x | 13.81 | x | 0.138 |
| LOCK-UP?               | FM7387          | PAPER/STL | 4 PASS            | 66              | INT TH    | 389.0 | x | 325.8     | x | 3.1  | 15.31 | x | 12.83 | x | 0.122 |
| LOCK-UP?               | FM7389          | PAPER/STL | 4 PASS            | 12              | EXT LG    | 413.5 | x | 337.0     | x | 3.1  | 16.28 | x | 13.27 | x | 0.122 |

# Facing Groove Details

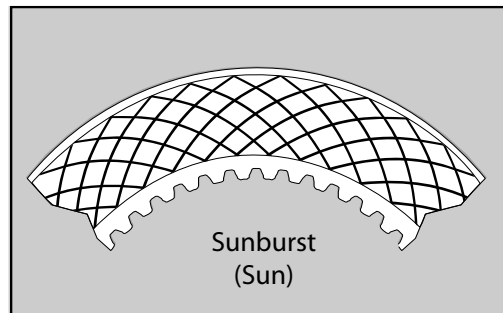
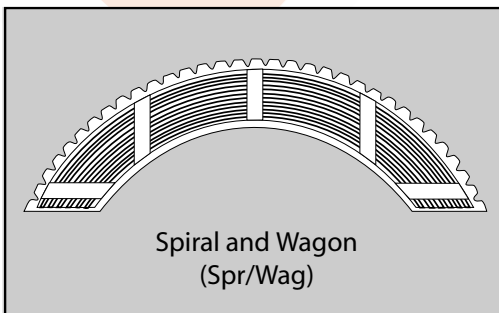
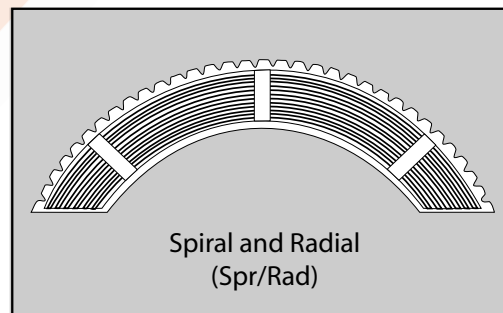
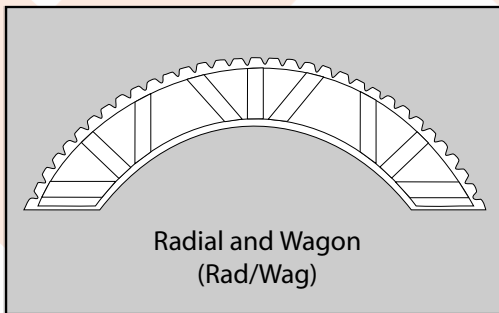
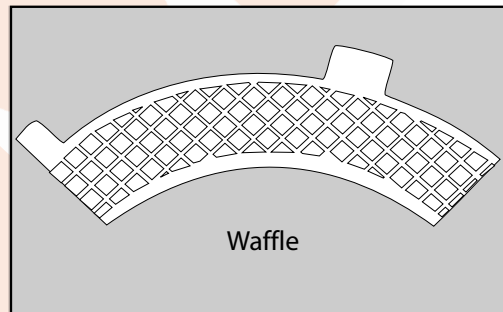
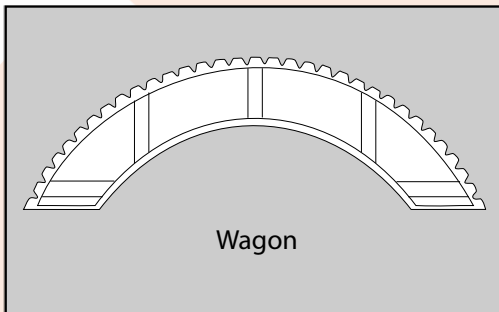
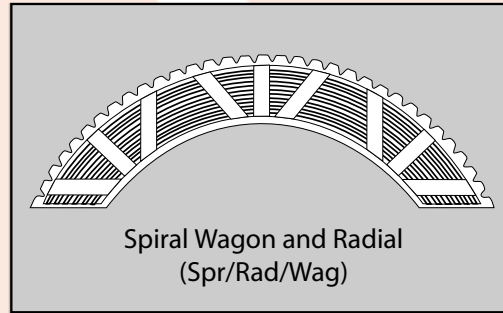
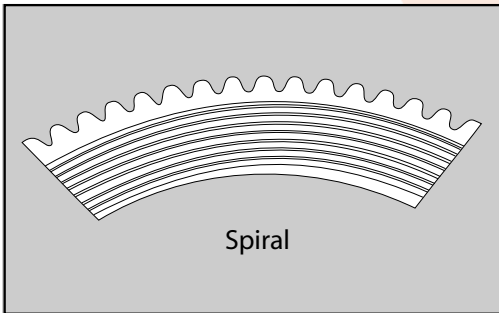
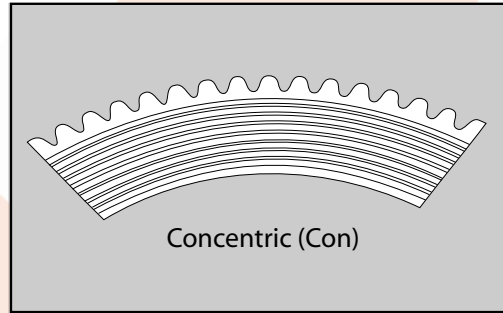
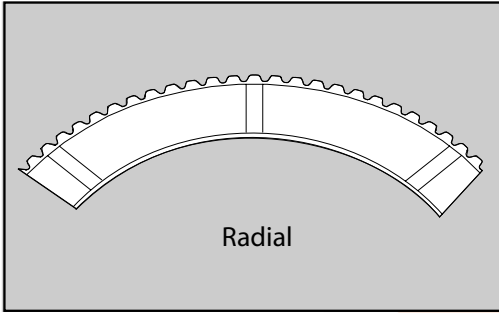
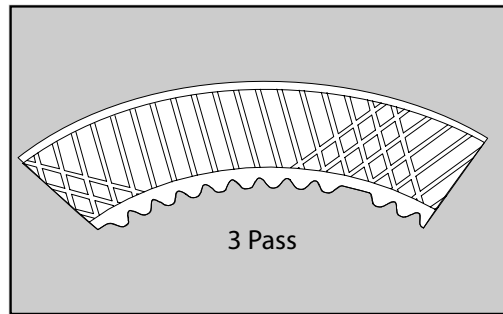
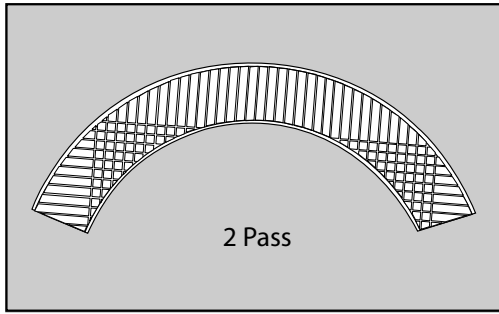

# Core Plate Drive Features

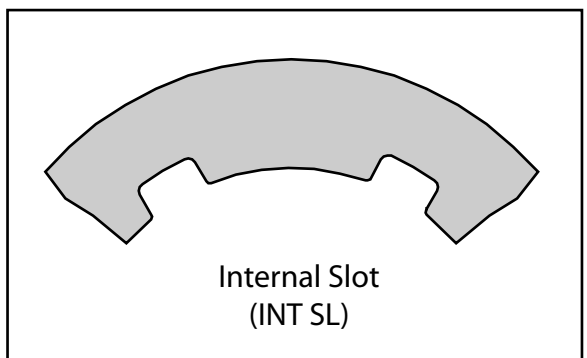
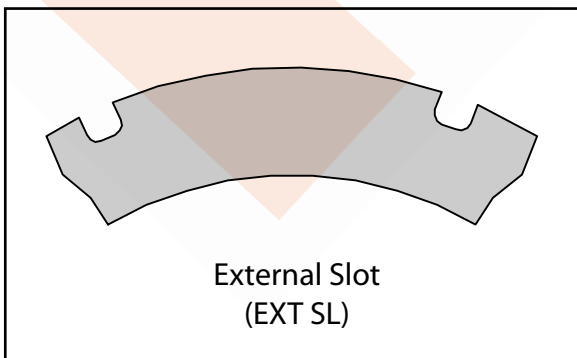
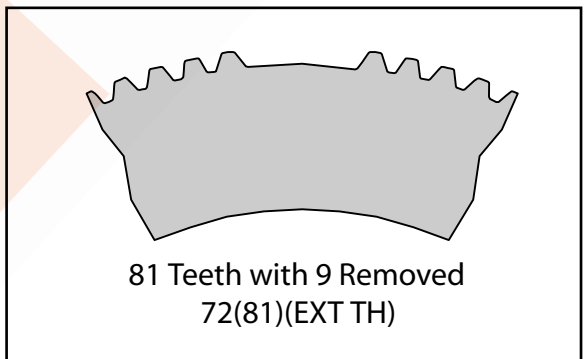
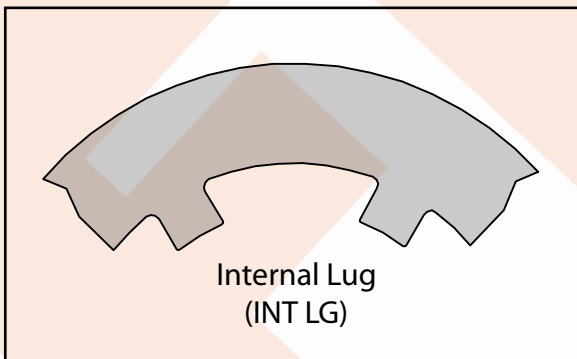
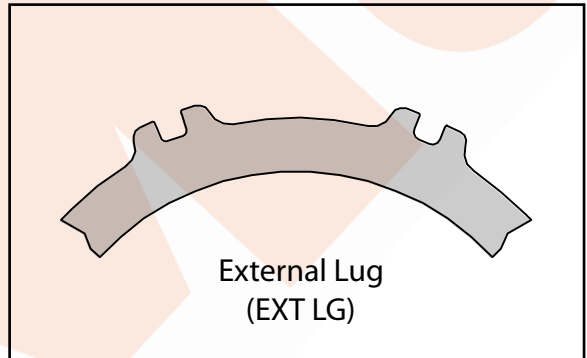
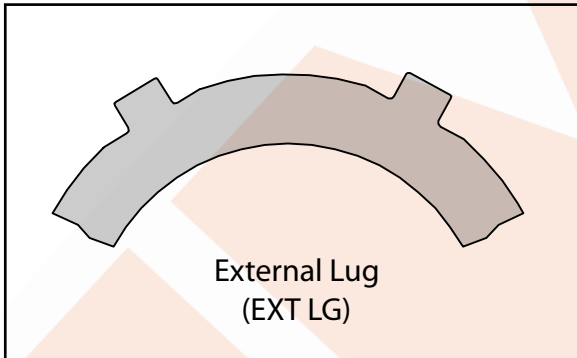
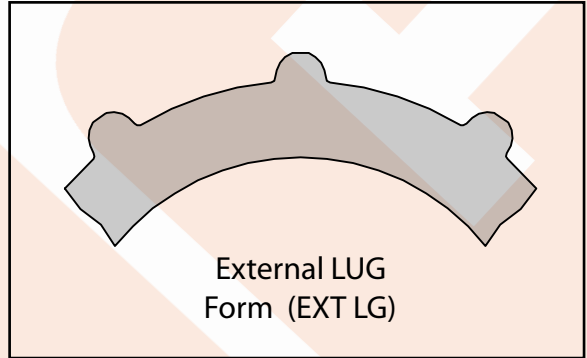
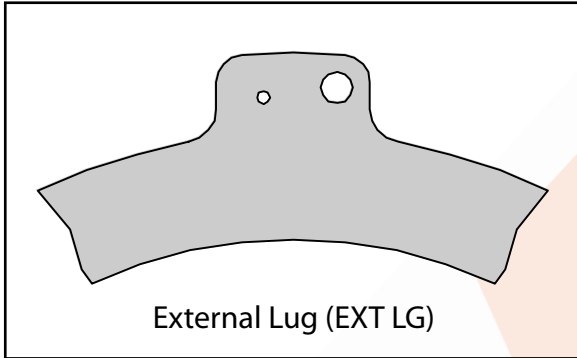
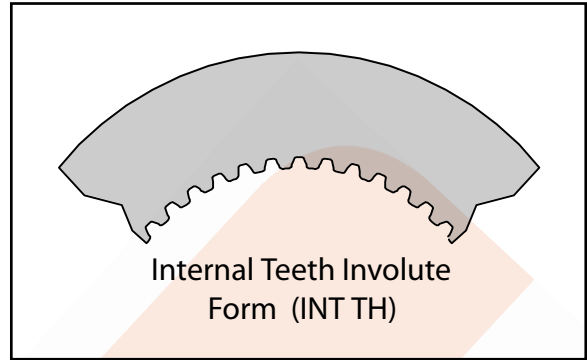
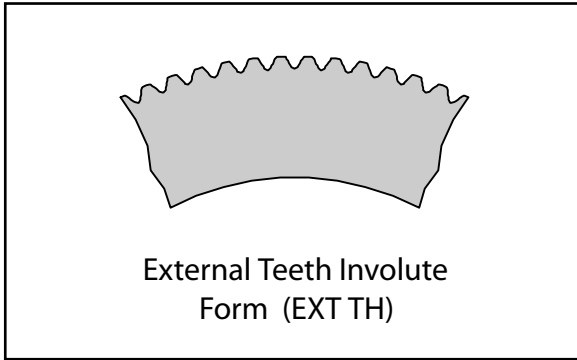

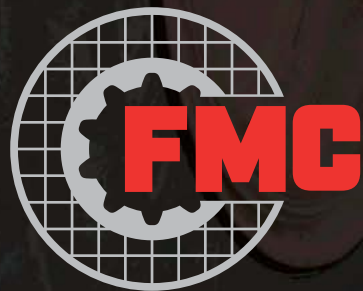

**Friction Marketing Company**  
Unit 5, Eden Court, Eden Way,  
Leighton Buzzard, LU7 4FY  
England.

Tel: +44 (0) 1525 376 700  
Fax: +44 (0) 1525 377 170  
Email: [info@frictionmarketing.co.uk](mailto:info@frictionmarketing.co.uk)  
[www.frictionmarketing.co.uk](http://www.frictionmarketing.co.uk)